



# CITY OF CAMBRIDGE

BOARD OF ZONING APPEAL

831 Massachusetts Avenue, Cambridge MA 02139

617-349-6100

## BZA Application Form

BZA Number: 243960

### General Information

The undersigned hereby petitions the Board of Zoning Appeal for the following:

Special Permit:  X  Variance:   Appeal:

2023 SEP 26 PM 2:24  
OFFICE OF THE CITY CLERK  
CAMBRIDGE, MASSACHUSETTS

**PETITIONER:** DISH Wireless, LLC C/O Michael R. Dolan, Esq. C/O Brown Rudnick LLP

**PETITIONER'S ADDRESS:** One Financial Center, Boston, MA 02111

**LOCATION OF PROPERTY:** 1815 Massachusetts Ave., Cambridge, MA

**TYPE OF OCCUPANCY:** Office/Retail-Store **ZONING DISTRICT:** Business C Zone

**REASON FOR PETITION:**

/Telecommunication Facility (antenna)/

**DESCRIPTION OF PETITIONER'S PROPOSAL:**

DISH proposes to mount three (3) panel antennas (one (1) antenna per sector) on the façade of the Building. Two (2) of the proposed antennas will be mounted at an antenna centerline height of 63'10"AGL, and one (1) antenna at a centerline height of 80'. The height of the proposed antennas will not exceed the height of the penthouse of the Building. DISH will also install on the exterior of the Building and adjacent to the antennas six (6) Remote Radio Units, and three (3) Over Voltage Protection devices. DISH will install equipment on a proposed equipment platform on the roof of the Building. DISH's facility will include related amplifiers, cables, fiber and other associated antenna equipment, including a global positioning system antenna, all as depicted on the Plans.

**SECTIONS OF ZONING ORDINANCE CITED:**

Article: 4.000      Section: 4.32.g.1 & Sec. 4.40 (Footnote 49) (Telecommunication Facility).  
Article: 10.000    Section: 10.40 (Special Permit).  
Article: 6409      Section: Federal Middle Class Tax Relief Act (Spectrum Act)

Original  
Signature(s):

Michael Dolan

(Petitioner (s) / Owner)

Michael R. Dolan

(Print Name)

Address:  
Tel. No.

One Financial Center, Boston, MA 02111  
4012615128

**BZA APPLICATION FORM - OWNERSHIP INFORMATION**

To be completed by OWNER, signed before a notary and returned to The Secretary of the Board of Zoning Appeals.

I/We Lesley University \_\_\_\_\_  
(OWNER)

Address: 29 Everett Street, Cambridge MA 02138 \_\_\_\_\_

State that I/We own the property located at 1815 Massachusetts Ave, Cambridge , which is the subject of this zoning application.

The record title of this property is in the name of Lesley University \_\_\_\_\_

\*Pursuant to a deed of duly recorded in the date 4/5/95 , Middlesex South County Registry of Deeds at Book 25269 , Page 543 ; or Middlesex Registry District of Land Court, Certificate No. 201866  
Book 1139 Page 116 .

Joanne Kosuth

SIGNATURE BY LAND OWNER OR AUTHORIZED TRUSTEE, OFFICER OR AGENT\*

\*Written evidence of Agent's standing to represent petitioner may be requested.

-----  
Commonwealth of Massachusetts, County of Middlesex \_\_\_\_\_

The above-name Joanne M. Kosuth personally appeared before me, this 29<sup>th</sup> of August, 2023, and made oath that the above statement is true.

[Signature] Notary

My commission expires

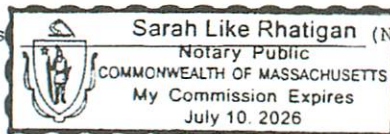

- If ownership is not shown in recorded deed, e.g. if by court order, recent deed, or inheritance, please include documentation.



## **BZA Application Form**

### **SUPPORTING STATEMENT FOR A SPECIAL PERMIT**

**Please describe in complete detail how you meet each of the following criteria referring to the property and proposed changes or uses which are requested in your application. Attach sheets with additional information for special permits which have additional criteria, e.g.; fast food permits, comprehensive permits, etc., which must be met.**

**Granting the Special Permit requested for 1815 Massachusetts Ave , Cambridge, MA (location) would not be a detriment to the public interest because:**

**A) Requirements of the Ordinance can or will be met for the following reasons:**

DISH's Facility will comply with all applicable sections of the Ordinance as the proposed antennas will be painted to match the Building to which they are attached, will not increase the height of the Building, and will not exceed the height of the existing antennas on the Building.

**B) Traffic generated or patterns of access or egress would not cause congestion hazard, or substantial change in established neighborhood character for the following reasons:**

DISH's Facility will not result in any substantial change in the character of the neighborhood as there will be no significant increase in the amount of traffic to and from the Site, or any changes to existing patterns of access or egress to the Site. Trips to and from the Facility will average one or two per month by maintenance personnel.

**C) The continued operation of or the development of adjacent uses as permitted in the Zoning Ordinance would not be adversely affected by the nature of the proposed use for the following reasons:**

The continued operation of or the development of adjacent uses will not be adversely affected by DISH's equipment because DISH's Facility will be a passive use and will not produce any smoke, odors, waste, glare, dust, or unreasonable amounts of traffic.

**D) Nuisance or hazard would not be created to the detriment of the health, safety, and/or welfare of the occupant of the proposed use or the citizens of the City for the following reasons:**

DISH's Facility will not result in any nuisance or hazard to the detriment of the health, safety, or welfare of the citizens of the City because DISH's Facility will be a passive use and will not produce any smoke, odors, waste, glare, dust, or unreasonable amounts of traffic. As evidenced by the MPE Study submitted herewith, DISH's Facility will comply with all applicable regulations and guidelines pertaining to radio frequency emissions.

**E) For other reasons, the proposed use would not impair the integrity of the district or adjoining district or otherwise derogate from the intent or purpose of this ordinance for the following reasons:**

The proposed Facility will be in harmony with the purposes of the Ordinance because by collocating a wireless facility on an existing Building in a manner which does not increase the height of the Building or expand its footprint, potential visual impacts are minimized. Also, the proposed Facility will not produce any smoke, odors, waste, glare or significant amounts of traffic. The Facility will have no negative impact on natural or undeveloped areas, wildlife, flora or endangered species.

Consistent with the Ordinance, the Facility will function as a wireless communications services facility within a local, regional, and national communications system. This system operates under

licenses from the FCC, and DISH is mandated and authorized to provide adequate service to the general public. The proposed Facility will comply with all applicable regulations, standards and guidelines with respect to radiofrequency emissions.

The Facility will benefit those living and working in, and traveling through, the area by providing enhanced wireless telecommunication services. The Facility will not adversely impact adjacent properties and neighborhoods as the Facility will be located on an existing Building. The collocation of the facility will not be a threat to public health, safety and welfare. In fact, Applicant submits that the facility aids in public safety by providing and improving wireless communications services to the residents, businesses, commuters, and emergency personnel utilizing wireless communications in the immediate vicinity and along the nearby roads. Consistent with the Ordinance, the Facility will function as a wireless communications services facility within a local, regional, and national communications system. This system operates under license from the FCC, and DISH is mandated and authorized to provide adequate service to the general public. The Facility will not generate any objectionable noise, odor, fumes, glare, smoke, or dust or require additional lighting or signage. The Facility will have no negative impact on property values in the area. This is an unmanned Facility and will have minimal negative effect on the adjoining lots.

**\*If you have any questions as to whether you can establish all of the applicable legal requirements, you should consult with an attorney.**

E-Mail Address: mdolan@brownrudnick.com

Date: September 22, 2023

**BZA Application Form**

**DIMENSIONAL INFORMATION**

**Applicant:** DISH Wireless, LLC  
**Location:** 1815 Massachusetts Ave., Cambridge, MA  
**Phone:** 4012615128

**Present Use/Occupancy:** Office/Retail-Store  
**Zone:** Business C Zone  
**Requested Use/Occupancy:** Telecommunications Facility

		<b><u>Existing Conditions</u></b>	<b><u>Requested Conditions</u></b>	<b><u>Ordinance Requirements</u></b>	
<b><u>TOTAL GROSS FLOOR AREA:</u></b>		N/A	No change	N/A	(max.)
<b><u>LOT AREA:</u></b>		N/A	No change	N/A	(min.)
<b><u>RATIO OF GROSS FLOOR AREA TO LOT AREA: <sup>2</sup></u></b>		N/A	No change	N/A	
<b><u>LOT AREA OF EACH DWELLING UNIT</u></b>		N/A	No change	N/A	
<b><u>SIZE OF LOT:</u></b>	WIDTH	N/A	No change	N/A	
	DEPTH	N/A	No change	N/A	
<b><u>SETBACKS IN FEET:</u></b>	FRONT	N/A	No change	N/A	
	REAR	N/A	No Change	N/A	
	LEFT SIDE	N/A	No change	N/A	
	RIGHT SIDE	N/A	No Change	N/A	
<b><u>SIZE OF BUILDING:</u></b>	HEIGHT	95'	No change	N/A	
	WIDTH	N/A	No change	N/A	
	LENGTH	N/A	No change	N/A	
<b><u>RATIO OF USABLE OPEN SPACE TO LOT AREA:</u></b>		N/A	No change	N/A	
<b><u>NO. OF DWELLING UNITS:</u></b>		N/A	No change	N/A	
<b><u>NO. OF PARKING SPACES:</u></b>		N/A	No change	N/A	
<b><u>NO. OF LOADING AREAS:</u></b>		N/A	No change	N/A	
<b><u>DISTANCE TO NEAREST BLDG. ON SAME LOT</u></b>		N/A	No change	N/A	

Describe where applicable, other occupancies on the same lot, the size of adjacent buildings on same lot, and type of construction proposed, e.g; wood frame, concrete, brick, steel, etc.:

N/A

1. SEE CAMBRIDGE ZONING ORDINANCE ARTICLE 5.000, SECTION 5.30 (DISTRICT OF DIMENSIONAL REGULATIONS).
2. TOTAL GROSS FLOOR AREA (INCLUDING BASEMENT 7'-0" IN HEIGHT AND ATTIC AREAS GREATER THAN 5') DIVIDED BY LOT AREA.
3. OPEN SPACE SHALL NOT INCLUDE PARKING AREAS, WALKWAYS OR DRIVEWAYS AND SHALL HAVE A MINIMUM DIMENSION OF 15'.



# brownrudnick

MICHAEL R. DOLAN  
direct dial: +1 617.856.8548  
mdolan@brownrudnick.com

October 05, 2023

City of Cambridge  
Board of Zoning Appeal  
Attn: Maria Pacheco  
831 Massachusetts Avenue  
Cambridge, MA 02139

# 243960

**RE: Request for Continuance/DISH Wireless, LLC ("DISH") Application for a Special Permit to install Wireless Telecommunications Transmission Equipment on the existing 42' above ground level ("AGL") building (the "Building") located at 1815 Massachusetts Avenue, Cambridge MA 02140 (Assessor's Parcel Identification Map 152, Lot 51)**

Dear Maria:

Per our telephone conversation today, I represent the applicant DISH who has a Special Permit application (referenced above) hearing scheduled for October 26th. Due to an unavoidable conflict, we are requesting a continuance of our hearing to the November 9th meeting of the Board of Zoning Appeal. Once you have been able to confirm our rescheduled hearing date please advise me of same.

Please do not hesitate to contact me if you have any questions and thank you for your assistance with the above request.

Best regards.

Sincerely,

**BROWN RUDNICK LLP**

*/s/ Michael R. Dolan*  
Michael R. Dolan



DISH WIRELESS, LLC. SITE ID:

**BOBOS00343A**

DISH WIRELESS, LLC. SITE ADDRESS:

**1815 MASSACHUSETTS AVE  
CAMBRIDGE, MA 02140**

**MASSACHUSETTS CODE COMPLIANCE**

ALL WORK SHALL BE PERFORMED AND MATERIALS INSTALLED IN ACCORDANCE WITH THE CURRENT EDITIONS OF THE FOLLOWING CODES AS ADOPTED BY THE LOCAL GOVERNING AUTHORITIES. NOTHING IN THESE PLANS IS TO BE CONSTRUED TO PERMIT WORK NOT CONFORMING TO THESE CODES:

CODE TYPE	CODE
BUILDING	MA STATE BUILDING CODE, 9TH EDITION (780 CMR)/2015 IBC W/ AMENDMENTS
MECHANICAL	MECHANICAL CODE 2015 OF MASSACHUSETTS/2015 IMC W/ AMENDMENTS
ELECTRICAL	MA ELECTRICAL CODE/2020 NEC W/ AMENDMENTS

**SHEET INDEX**

SHEET NO.	SHEET TITLE
T-1	TITLE SHEET
Z-1	ZONING PLAN
A-1	BUILDING PLAN
A-2	ANTENNA PLAN, ELEVATION AND SCHEDULE
A-3	BUILDING ELEVATION
A-4	EQUIPMENT PLATFORM AND H-FRAME DETAILS
A-5	EQUIPMENT DETAILS
A-6	EQUIPMENT DETAILS
E-1	ELECTRICAL/FIBER ROUTE PLAN AND NOTES
E-2	ELECTRICAL DETAILS
E-3	ELECTRICAL ONE-LINE, FAULT CALCS & PANEL SCHEDULE
G-1	GROUNDING PLANS AND NOTES
G-2	GROUNDING DETAILS
G-3	GROUNDING DETAILS
RF-1	RF CABLE COLOR CODE
GN-1	LEGEND AND ABBREVIATIONS
GN-2	GENERAL NOTES
GN-3	GENERAL NOTES
GN-4	GENERAL NOTES

**SCOPE OF WORK**

THIS IS NOT AN ALL INCLUSIVE LIST. CONTRACTOR SHALL UTILIZE SPECIFIED EQUIPMENT PART OR ENGINEER APPROVED EQUIVALENT. CONTRACTOR SHALL VERIFY ALL NEEDED EQUIPMENT TO PROVIDE A FUNCTIONAL SITE. THE PROJECT GENERALLY CONSISTS OF THE FOLLOWING:

- SECTOR SCOPE OF WORK:
- INSTALL (3) PROPOSED PANEL ANTENNAS (1 PER SECTOR)
  - INSTALL (3) PROPOSED ANTENNA MOUNTS (1 PER SECTOR)
  - INSTALL PROPOSED JUMPERS
  - INSTALL (6) PROPOSED RRU's (2 PER SECTOR)
  - INSTALL (3) PROPOSED OVER VOLTAGE PROTECTION DEVICE (OVP) (1 PER SECTOR)
  - INSTALL (3) PROPOSED DC POWER CABLES (1 PER SECTOR)
  - INSTALL (3) PROPOSED FIBER TRUNKS (1 PER SECTOR)

- ROOFTOP SCOPE OF WORK:
- INSTALL (1) PROPOSED METAL PLATFORM WITH H-FRAME
  - INSTALL (1) PROPOSED CABLE LADDER TRAY AND CABLE TRAY
  - INSTALL (1) PROPOSED BBU IN CABINET
  - INSTALL (1) PROPOSED EQUIPMENT CABINET
  - INSTALL (1) PROPOSED NEMA 3 TELCO-FIBER BOX
  - INSTALL (1) PROPOSED GPS UNIT
  - INSTALL (1) PROPOSED GROUNDING CONDUIT
  - INSTALL (1) PROPOSED POWER CONDUIT
  - INSTALL (1) PROPOSED FIBER CONDUIT

**SITE INFORMATION**

PROPERTY OWNER: LESLEY COLLEGE  
 ADDRESS: 1815 MASSACHUSETTS AVE  
 CAMBRIDGE, MA 02140

TOWER TYPE: ROOFTOP

TOWER CO SITE ID: N/A

TOWER APP NUMBER: N/A

COUNTY: MIDDLESEX

LATITUDE (NAD 83): 42° 23' 13.9668" N  
 42.387213 N

LONGITUDE (NAD 83): 71° 07' 06.9600" W  
 71.118600 W

ZONING JURISDICTION: CITY OF CAMBRIDGE, MA

ZONING DISTRICT: SPECIAL PERMIT

PARCEL NUMBER: 000152-000000-000051E

OCCUPANCY GROUP: U

CONSTRUCTION TYPE: II-B

POWER COMPANY: EVERSOURCE/NSTAR

TELEPHONE COMPANY: COMCAST

**PROJECT DIRECTORY**

APPLICANT: DISH WIRELESS, LLC.  
 5701 SOUTH SANTA FE DRIVE  
 LITTLETON, CO 80120

TOWER MANAGER: LESLEY COLLEGE  
 1815 MASSACHUSETTS AVE  
 CAMBRIDGE, MA 02140  
 (781) 431-1039

SITE DESIGNER: NB+C ENGINEERING SERVICES, LLC  
 100 APOLLO DRIVE, SUITE 303  
 CHELMSFORD, MA 01824  
 (978) 856-8308

SITE ACQUISITION: ANDREW GORHAM  
 AGORHAM@NBCLLC.COM

CONSTRUCTION MANAGER: AARON CHANDLER  
 AARON.CHANDLER@DISH.COM

RF ENGINEER: VICTORIEN NDOUNOU  
 VICTORIEN.NDOUNOU@DISH.COM

**SITE PHOTO**



**DIRECTIONS**

**DIRECTIONS FROM LOGAN AIRPORT:**  
 DESTINATION IS 7.5 MILES FROM AIRPORT. THIS ROUTE HAS TOLLS. GET ON MA-1A SOUTH (FROM AIRPORT RD - ARRIVAL LEVEL, KEEP RIGHT AND FOLLOW SIGNS FOR MA-1A S / I-93 N / SUMNER TUNNEL / GOV'T CENTER). ON MA-1A S, KEEP RIGHT, FOLLOW SIGNS FOR I-93 N, AND MERGE ONTO I-93 N. ON I-93 N, TAKE EXIT 20 (MA 99 / SULLIVAN SQUARE / SOMERVILLE). TAKE FIRST LEFT (CAMBRIDGE STREET). FOR NEXT 0.7 MILES, CAMBRIDGE STREET BECOMES WASHINGTON STREET, WHICH TURNS SLIGHTLY LEFT AND BECOMES PROSPECT STREET. AFTER 200 FEET, TURN RIGHT ONTO SOMERVILLE AVE / UNION SQUARE. AFTER 0.6 MILES, TAKE SLIGHT LEFT ONTO WASHINGTON STREET. AFTER 0.7 MILES, TURN RIGHT ONTO BEACON STREET. AFTER 0.8 MILES, TURN LEFT ONTO ROSELAND STREET. DESTINATION IS AT END OF ROSELAND STREET ON RIGHT SIDE.

**VICINITY MAP**

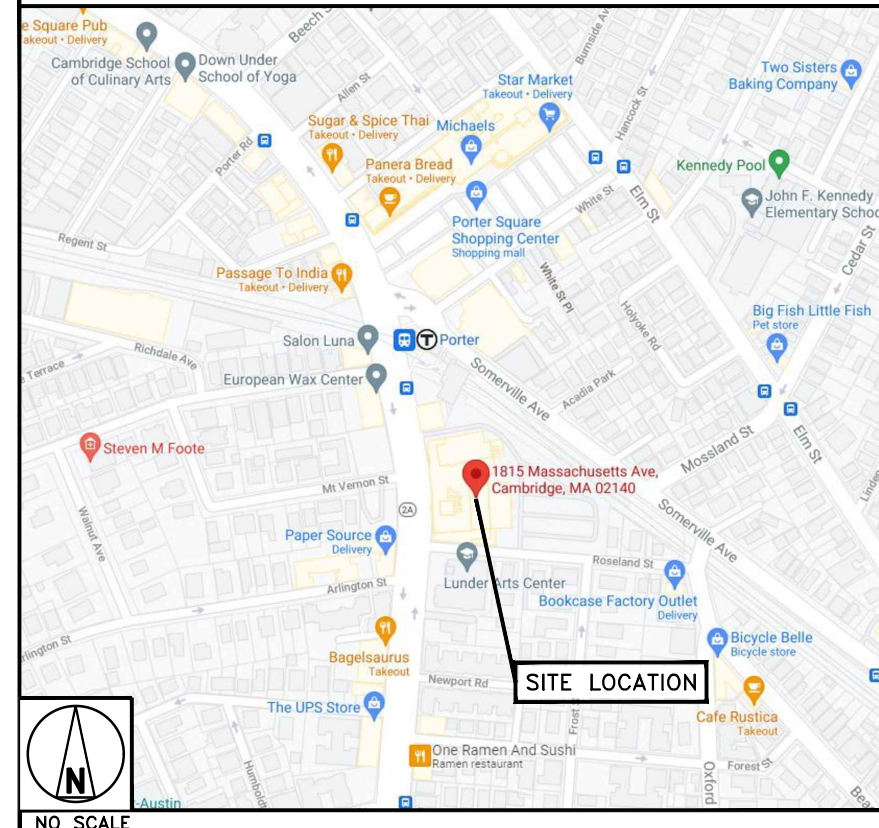

**UNDERGROUND SERVICE ALERT - 811 DIG SAFE**  
 UTILITY NOTIFICATION CENTER OF MASSACHUSETTS  
 (888) 344-7233  
 WWW.DIGSAFE.COM

CALL 3 WORKING DAYS UTILITY NOTIFICATION PRIOR TO CONSTRUCTION

**GENERAL NOTES**

THE FACILITY IS UNMANNED AND NOT FOR HUMAN HABITATION. A TECHNICIAN WILL VISIT THE SITE AS REQUIRED FOR ROUTINE MAINTENANCE. THE PROJECT WILL NOT RESULT IN ANY SIGNIFICANT DISTURBANCE OR EFFECT ON DRAINAGE. NO SANITARY SEWER SERVICE, POTABLE WATER, OR TRASH DISPOSAL IS REQUIRED AND NO COMMERCIAL SIGNAGE IS PROPOSED.

**11"x17" PLOT WILL BE HALF SCALE UNLESS OTHERWISE NOTED**

CONTRACTOR SHALL VERIFY ALL PLANS, EXISTING DIMENSIONS, AND CONDITIONS ON THE JOB SITE, AND SHALL IMMEDIATELY NOTIFY THE ENGINEER IN WRITING OF ANY DISCREPANCIES BEFORE PROCEEDING WITH THE WORK.



5701 SOUTH SANTA FE DRIVE  
 LITTLETON, CO 80120



**NB+C ENGINEERING SERVICES, LLC.**

100 APOLLO DRIVE  
 SUITE 303  
 CHELMSFORD, MA 01824  
 (978) 856-8308



IT IS A VIOLATION OF LAW FOR ANY PERSON, UNLESS THEY ARE ACTING UNDER THE DIRECTION OF A LICENSED PROFESSIONAL ENGINEER, TO ALTER THIS DOCUMENT.

DRAWN BY:	CHECKED BY:	APPROVED BY:
CWE	NSB	DRG

RFDS REV #: 1

**CONSTRUCTION DOCUMENTS**

SUBMITTALS		
REV	DATE	DESCRIPTION
0	01/20/22	ISSUED FOR CONSTRUCTION
1	06/27/23	UTILITY ROUTES REVISED

A&E PROJECT NUMBER  
**100753**

DISH WIRELESS, LLC.  
 PROJECT INFORMATION  
**BOBOS00343A**

**1815 MASSACHUSETTS AVE.  
 CAMBRIDGE, MA 02140**

SHEET TITLE  
**TITLE SHEET**

SHEET NUMBER  
**T-1**







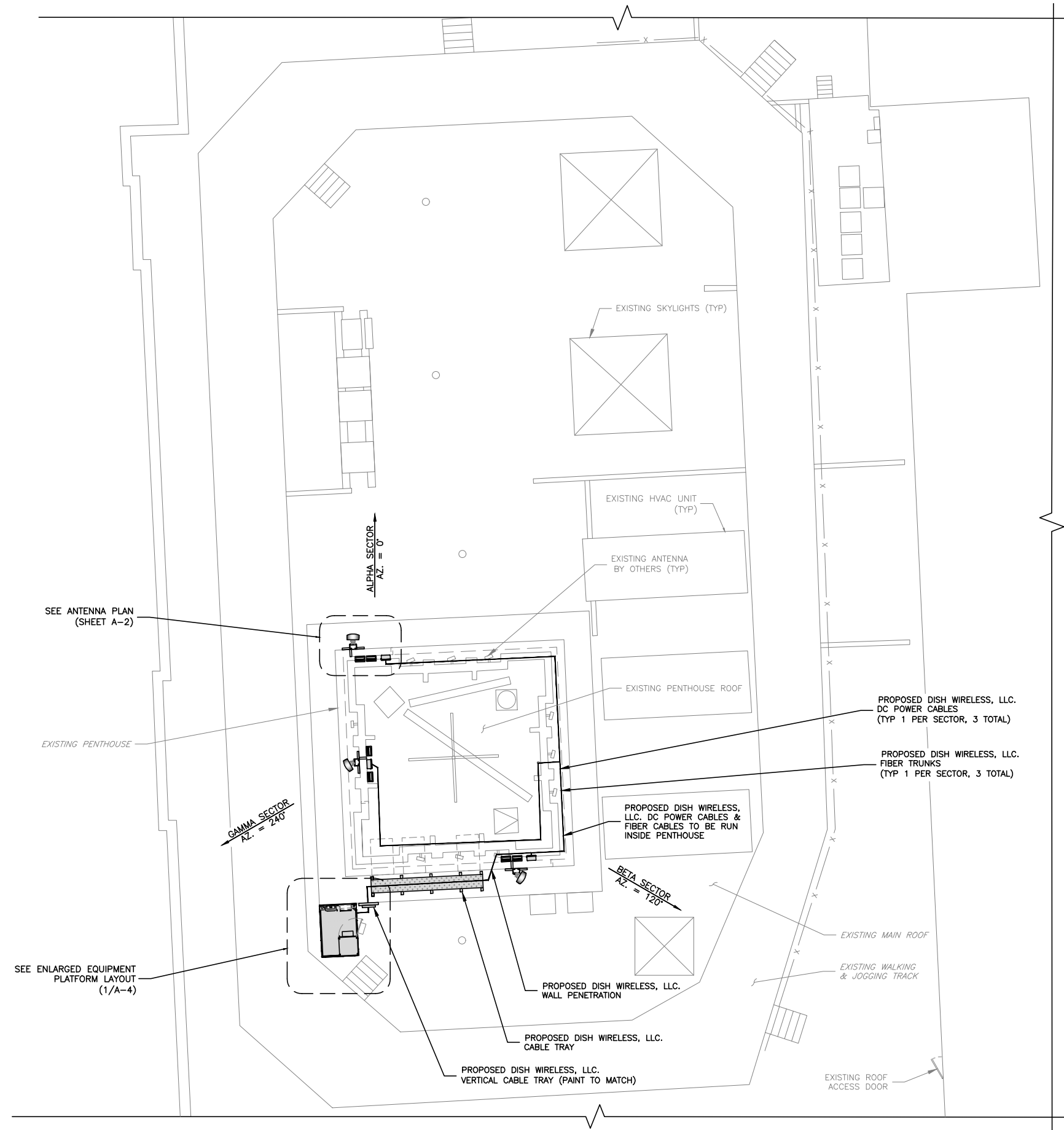

**NOTES**

1. CONTRACTOR SHALL FIELD VERIFY ALL DIMENSIONS.
2. CONTRACTOR SHALL MAINTAIN A 10'-0" MINIMUM SEPARATION BETWEEN THE PROPOSED GPS UNIT, TRANSMITTING ANTENNAS AND EXISTING GPS UNITS.
3. CONTRACTOR TO VERIFY WITH DISH WIRELESS, LLC. C.M. THE LOCATION OF THE POWER AND FIBER SOURCE PRIOR TO CONSTRUCTION.
4. UTILITY RUBBER MAT TO BE INSTALLED UNDER ALL DISH WIRELESS, LLC. EQUIPMENT THAT IS RESTING ON OR AFFIXED TO ROOF MEMBRANE



5701 SOUTH SANTA FE DRIVE  
LITTLETON, CO 80120



**NB+C ENGINEERING SERVICES, LLC.**

100 APOLLO DRIVE  
SUITE 303  
CHELMSFORD, MA 01824  
(978) 856-8308



IT IS A VIOLATION OF LAW FOR ANY PERSON, UNLESS THEY ARE ACTING UNDER THE DIRECTION OF A LICENSED PROFESSIONAL ENGINEER, TO ALTER THIS DOCUMENT.

DRAWN BY:	CHECKED BY:	APPROVED BY:
CWE	NSB	DRG

RFDS REV #: 1

**CONSTRUCTION DOCUMENTS**

SUBMITTALS		
REV	DATE	DESCRIPTION
0	01/20/22	ISSUED FOR CONSTRUCTION
1	06/27/23	UTILITY ROUTES REVISED

A&E PROJECT NUMBER  
**100753**

DISH WIRELESS, LLC.  
PROJECT INFORMATION  
**BOBOS00343A**

1815 MASSACHUSETTS AVE.  
CAMBRIDGE, MA 02140

SHEET TITLE  
**BUILDING PLAN**

SHEET NUMBER  
**A-1**

**BUILDING PLAN**

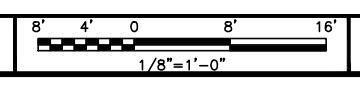

**NOTES**

1. CONTRACTOR SHALL FIELD VERIFY ALL DIMENSIONS.
2. ANTENNA AND MW DISH SPECIFICATIONS REFER TO ANTENNA SCHEDULE AND TO FINAL CONSTRUCTION RFDS FOR ALL RF DETAILS
3. EXISTING EQUIPMENT AND FENCE OMITTED FOR CLARITY.
4. ALPHA SECTOR SHOWN TYPICAL FOR BETA AND GAMMA SECTORS.

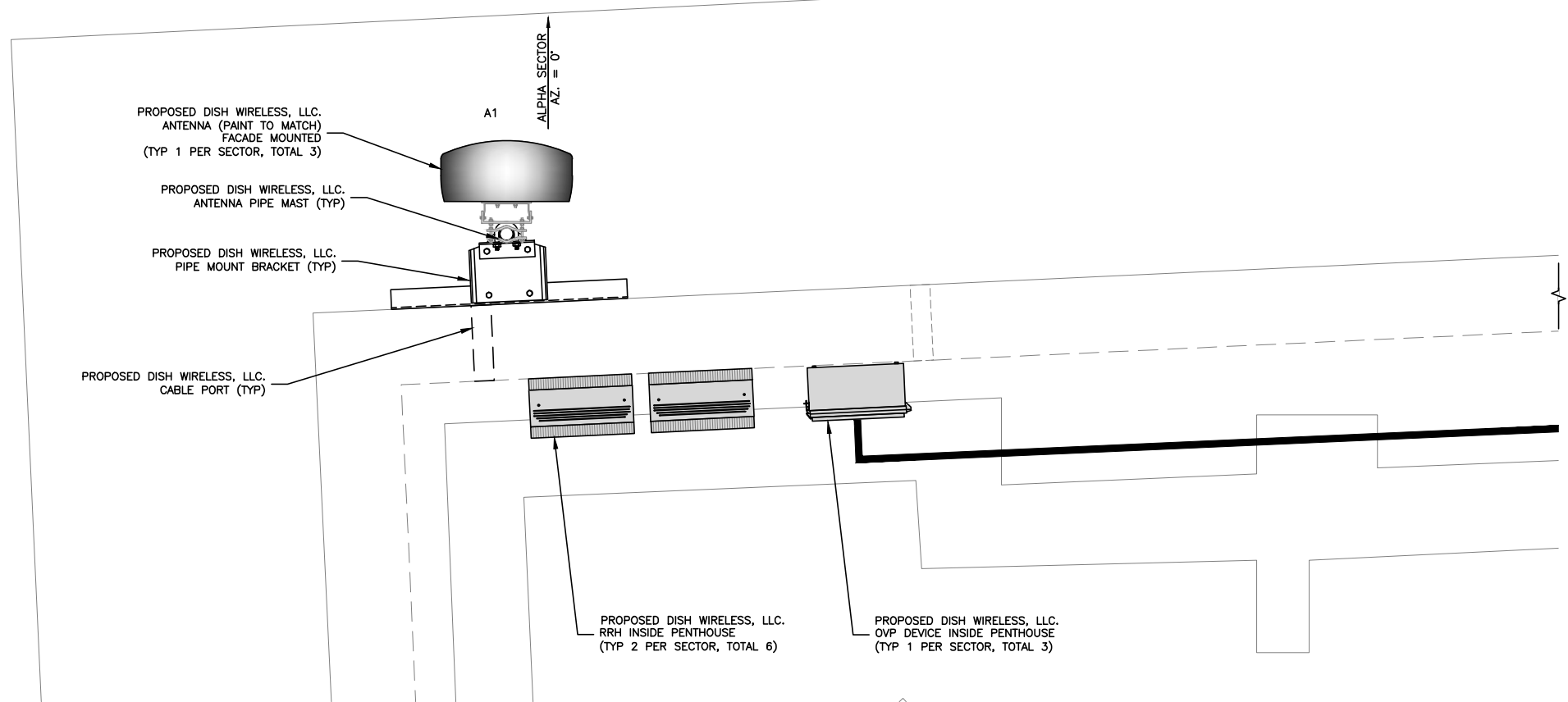

**ANTENNA PLAN (TYPICAL PER SECTOR)**

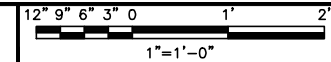

1

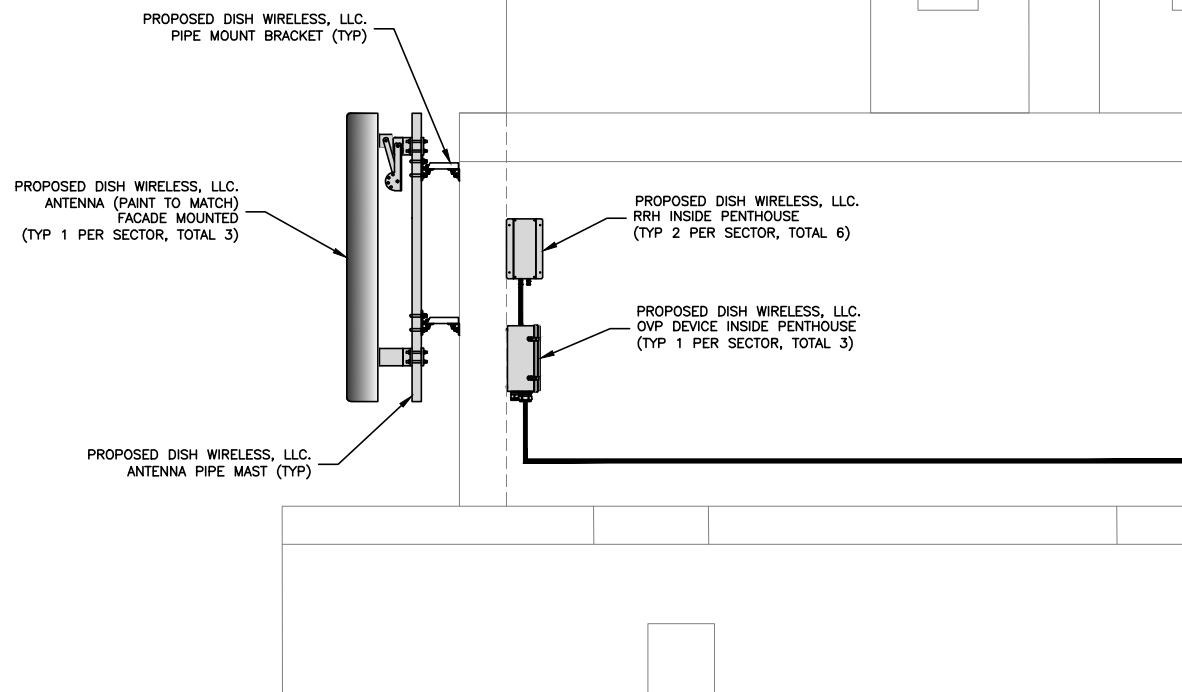

**ANTENNA ELEVATION**

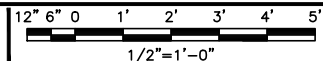

2

SECTOR POS.	ANTENNA					TRANSMISSION CABLE FEED LINE TYPE AND LENGTH	RRH			OVP MANUFACTURER MODEL
	EXISTING OR PROPOSED	MANUFACTURER - MODEL NUMBER	TECH	AZIMUTH	RAD CENTER		MANUFACTURER - MODEL NUMBER	TECH	POS.	
A1	PROPOSED	JMA - MX08FR0665-21	5G	0°	63'-10"	(1) 6AWG DC POWER CABLE (1) FIBER TRUNK (LENGTH: 130'±)	SAMSUNG - MID BAND SFG-ARR3KM01DL_RF4451D-70A	5G	A1	RAYCAP RDIC-3045-PF-48
A2	--	--	--	--	--		SAMSUNG - LOW BAND SFG-ARR3J601DL_RF4450T-71A	5G	A1	
A3	--	--	--	--	--		--	--	--	
B1	PROPOSED	JMA - MX08FR0665-21	5G	120°	63'-10"	(1) 6AWG DC POWER CABLE (1) FIBER TRUNK (LENGTH: 80'±)	SAMSUNG - MID BAND SFG-ARR3KM01DL_RF4451D-70A	5G	B1	RAYCAP RDIC-3045-PF-48
B2	--	--	--	--	--		SAMSUNG - LOW BAND SFG-ARR3J601DL_RF4450T-71A	5G	B1	
B3	--	--	--	--	--		--	--	--	
C1	PROPOSED	JMA - MX08FR0665-21	5G	240°	80'-0"	(1) 6AWG DC POWER CABLE (1) FIBER TRUNK (LENGTH: 160'±)	SAMSUNG - MID BAND SFG-ARR3KM01DL_RF4451D-70A	5G	C1	RAYCAP RDIC-3045-PF-48
C2	--	--	--	--	--		SAMSUNG - LOW BAND SFG-ARR3J601DL_RF4450T-71A	5G	C1	
C3	--	--	--	--	--		--	--	--	

**NOTES**

1. CONTRACTOR TO REFER TO FINAL CONSTRUCTION RFDS FOR ALL RF DETAILS.
2. ANTENNA AND RRH MODELS MAY CHANGE DUE TO EQUIPMENT AVAILABILITY. ALL EQUIPMENT CHANGES MUST BE APPROVED AND REMAIN IN COMPLIANCE WITH THE PROPOSED DESIGN AND STRUCTURAL ANALYSES.

**ANTENNA SCHEDULE**

NO SCALE

3



5701 SOUTH SANTA FE DRIVE  
LITTLETON, CO 80120



**NB+C ENGINEERING SERVICES, LLC.**

100 APOLLO DRIVE  
SUITE 303  
CHELMSFORD, MA 01824  
(978) 856-8308



IT IS A VIOLATION OF LAW FOR ANY PERSON, UNLESS THEY ARE ACTING UNDER THE DIRECTION OF A LICENSED PROFESSIONAL ENGINEER, TO ALTER THIS DOCUMENT.

DRAWN BY: CWB  
CHECKED BY: NSB  
APPROVED BY: DRG

RFDS REV #: 1

**CONSTRUCTION DOCUMENTS**

SUBMITTALS		
REV	DATE	DESCRIPTION
0	01/20/22	ISSUED FOR CONSTRUCTION
1	06/27/23	UTILITY ROUTES REVISED

A&E PROJECT NUMBER

100753

DISH WIRELESS, LLC.  
PROJECT INFORMATION  
BOBOS00343A

1815 MASSACHUSETTS AVE.  
CAMBRIDGE, MA 02140

SHEET TITLE  
ANTENNA PLAN,  
ELEVATION AND SCHEDULE

SHEET NUMBER

**A-2**

**NOTES**

1. CONTRACTOR SHALL FIELD VERIFY ALL DIMENSIONS.
2. CONTRACTOR SHALL MAINTAIN A 10'-0" MINIMUM SEPARATION BETWEEN THE PROPOSED GPS UNIT, TRANSMITTING ANTENNAS AND EXISTING GPS UNITS.
3. EXISTING ABANDONED METROPCS CONDUITS TO BE EXTENDED FROM TERMINATIONS AT FLOOR LEVEL IN THE PENTHOUSE TO DISH EQUIPMENT CABINETS ALONG INTERIOR WALLS AS REQUIRED.



5701 SOUTH SANTA FE DRIVE  
LITTLETON, CO 80120



**NB+C ENGINEERING SERVICES, LLC.**

100 APOLLO DRIVE  
SUITE 303  
CHELMSFORD, MA 01824  
(978) 856-8308



IT IS A VIOLATION OF LAW FOR ANY PERSON, UNLESS THEY ARE ACTING UNDER THE DIRECTION OF A LICENSED PROFESSIONAL ENGINEER, TO ALTER THIS DOCUMENT.

DRAWN BY:	CHECKED BY:	APPROVED BY:
CWE	NSB	DRG

RFDS REV #: 1

**CONSTRUCTION DOCUMENTS**

SUBMITTALS		
REV	DATE	DESCRIPTION
0	01/20/22	ISSUED FOR CONSTRUCTION
1	06/27/23	UTILITY ROUTES REVISED

A&E PROJECT NUMBER  
**100753**

DISH WIRELESS, LLC.  
PROJECT INFORMATION  
**BOBOS00343A**

1815 MASSACHUSETTS AVE.  
CAMBRIDGE, MA 02140

SHEET TITLE  
**BUILDING ELEVATION**

SHEET NUMBER  
**A-3**

TOP OF FLAGPOLE / HIGHEST APPURTENANCE  
117'-0" AGL

TOP OF PENTHOUSE  
95'-0" AGL

PROPOSED DISH WIRELESS, LLC. ANTENNA (GAMMA SECTOR)  
RAD CENTER @ 80'-0" AGL

PROPOSED DISH WIRELESS, LLC. ANTENNA (ALPHA AND BETA SECTORS)  
RAD CENTER @ 63'-10" AGL

EXISTING BUILDING PARAPET  
44'-0" AGL

EXISTING BUILDING ROOF  
42'-0" AGL

EXISTING GROUND LEVEL  
0'-0" AGL

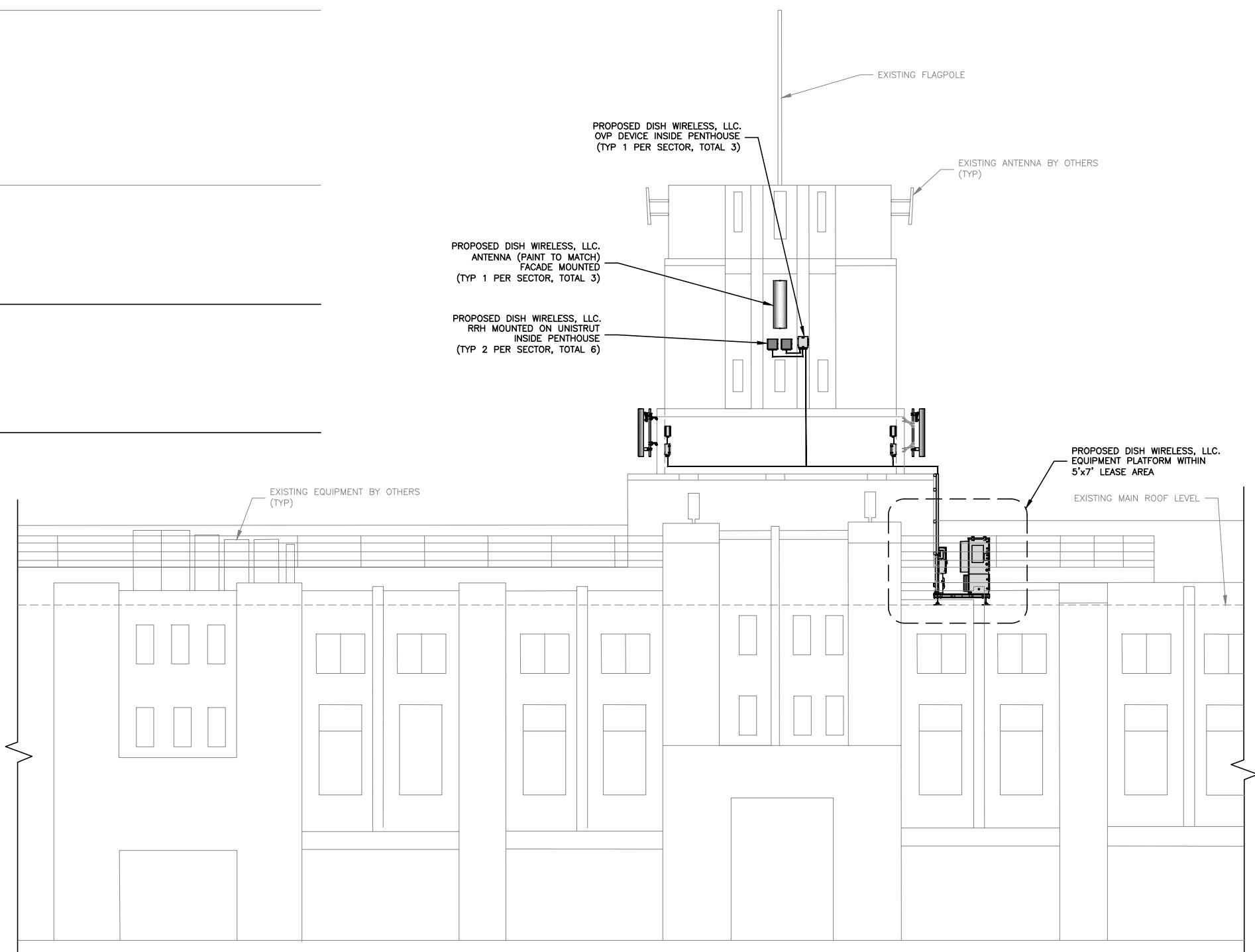

**BUILDING ELEVATION**

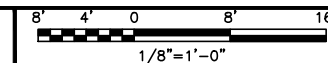



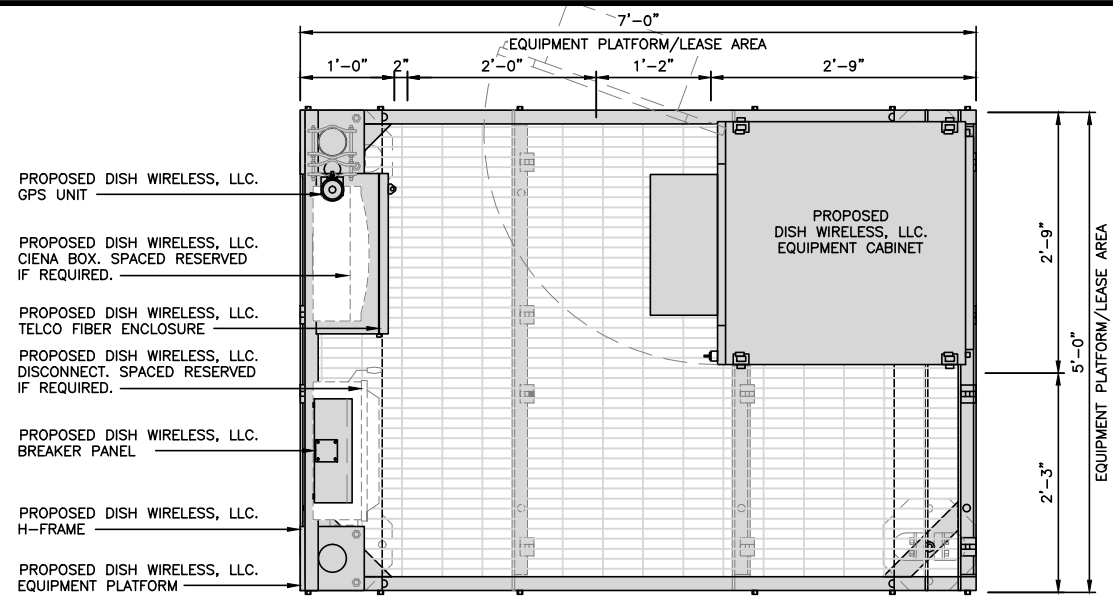

PLATFORM EQUIPMENT PLAN

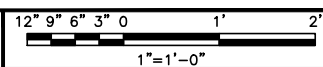

1

**NOTE**  
1. EQUIPMENT CABINET OMITTED FOR CLARITY

COMMSCOPE MTC4045LP 5X7 PLATFORM	
DIMENSIONS (HxWxD)	16"x84"x60"
TOTAL WEIGHT	423 LBS

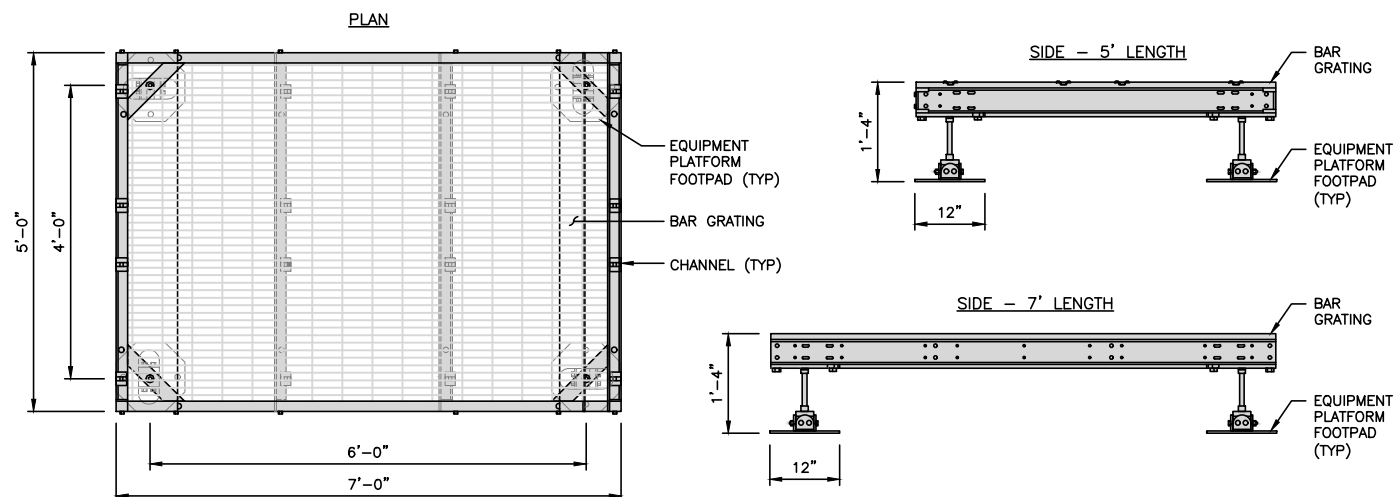

PLATFORM DETAIL

NO SCALE 2

KENWOOD T1701KT5-5S H-FRAME	
UNISTRUT/SUPPORT RAIL	5
WEIGHT/ VOLUME	173.6 LBS

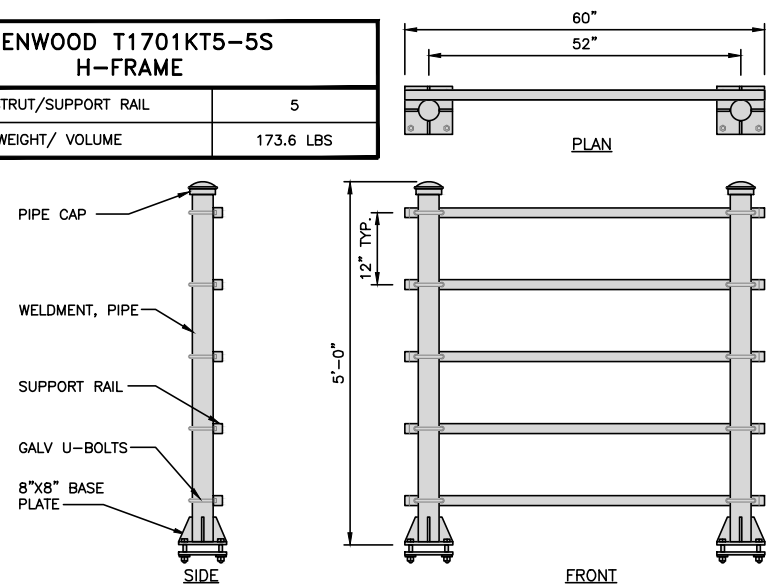

H-FRAME DETAIL

NO SCALE 3

UTILITY RUBBER MAT, BLACK	
DIMENSIONS	4'x 3'x 1/2"
WEIGHT/ VOLUME	36.5 LB AVERAGE
MATERIAL	100% RECYCLE RUBBER

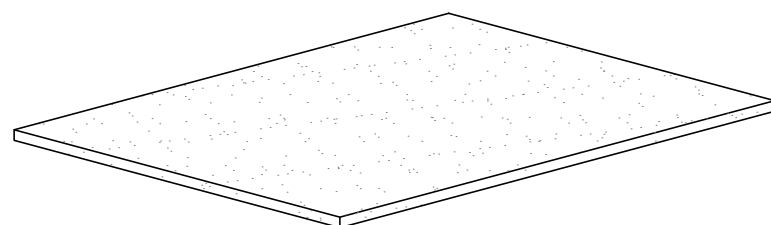

UTILITY RUBBER MAT DETAIL

NO SCALE 4

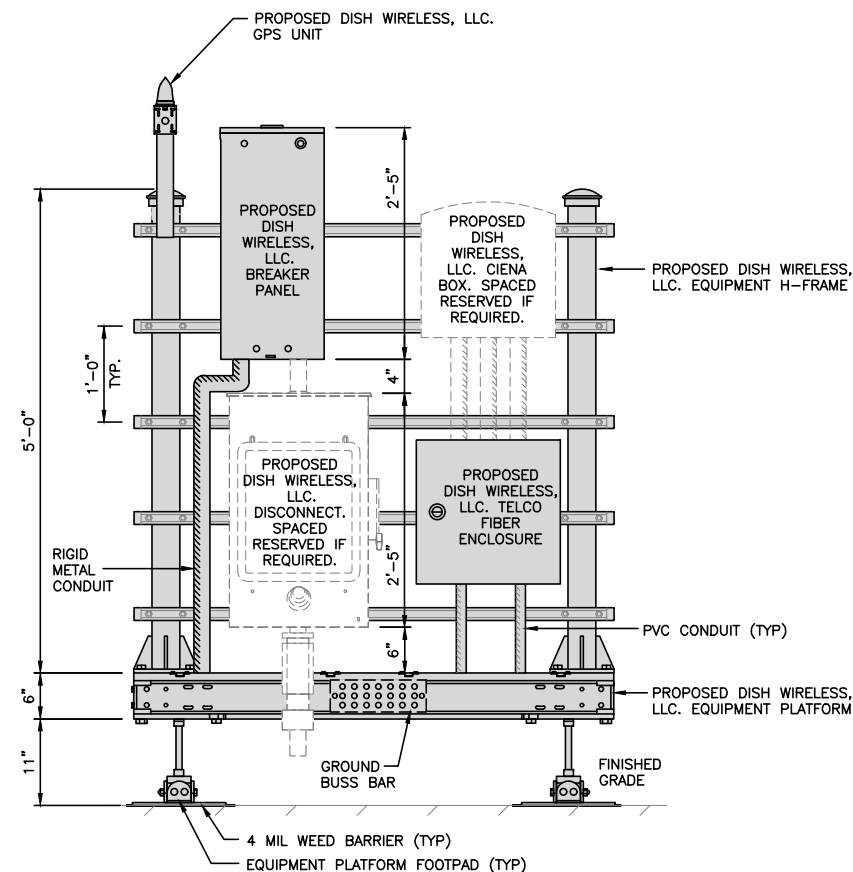

H-FRAME EQUIPMENT ELEVATION

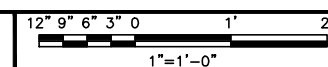

5



5701 SOUTH SANTA FE DRIVE  
LITTLETON, CO 80120



NB+C ENGINEERING SERVICES, LLC.

100 APOLLO DRIVE  
SUITE 303  
CHELMSFORD, MA 01824  
(978) 856-8308



IT IS A VIOLATION OF LAW FOR ANY PERSON, UNLESS THEY ARE ACTING UNDER THE DIRECTION OF A LICENSED PROFESSIONAL ENGINEER, TO ALTER THIS DOCUMENT.

DRAWN BY: CHECKED BY: APPROVED BY:  
CWE NSB DRG

RFDS REV #: 1

CONSTRUCTION DOCUMENTS

SUBMITTALS		
REV	DATE	DESCRIPTION
0	01/20/22	ISSUED FOR CONSTRUCTION
1	06/27/23	UTILITY ROUTES REVISED

A&E PROJECT NUMBER

100753

DISH WIRELESS, LLC. PROJECT INFORMATION

BOBOS00343A

1815 MASSACHUSETTS AVE.  
CAMBRIDGE, MA 02140

SHEET TITLE  
EQUIPMENT PLATFORM AND  
H-FRAME DETAILS

SHEET NUMBER

A-4

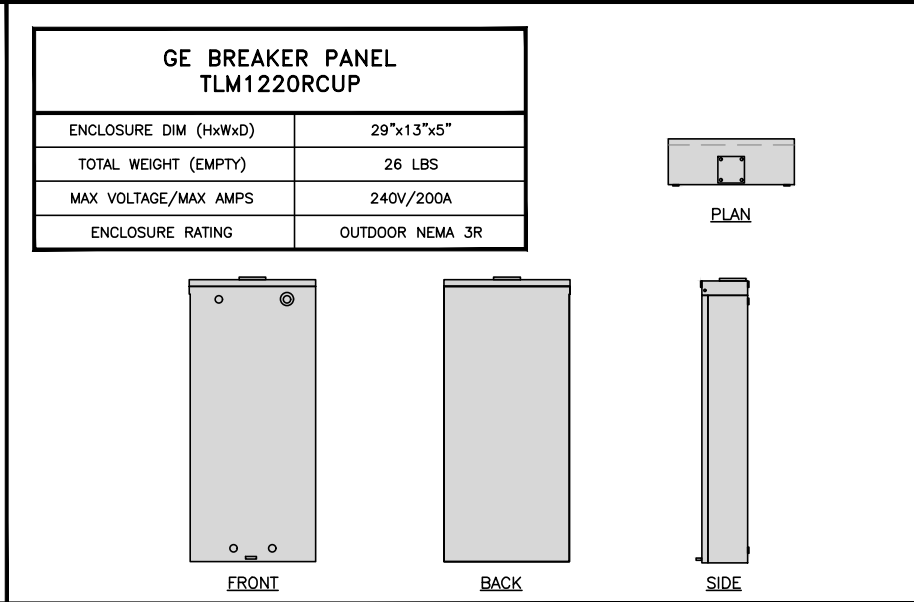
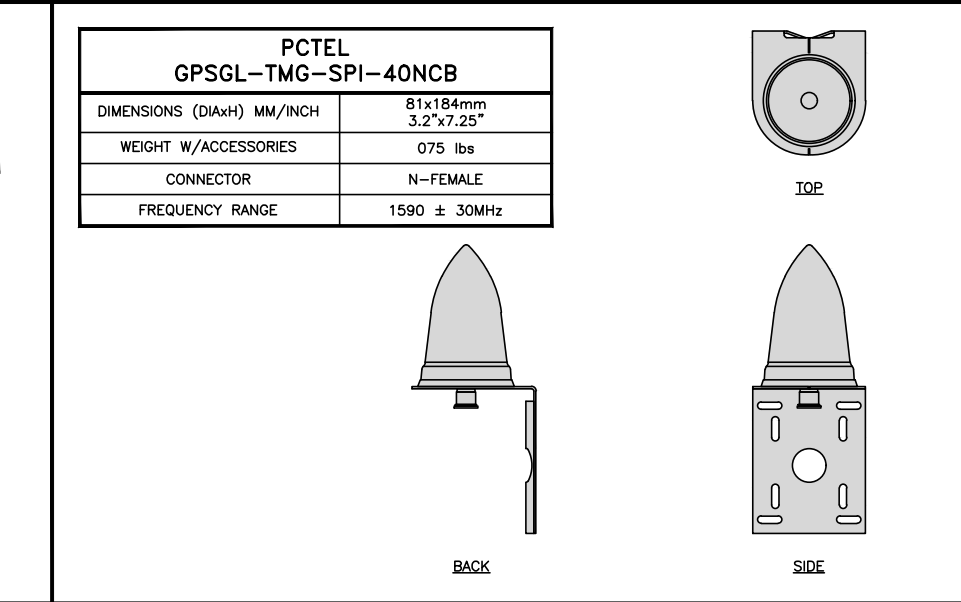
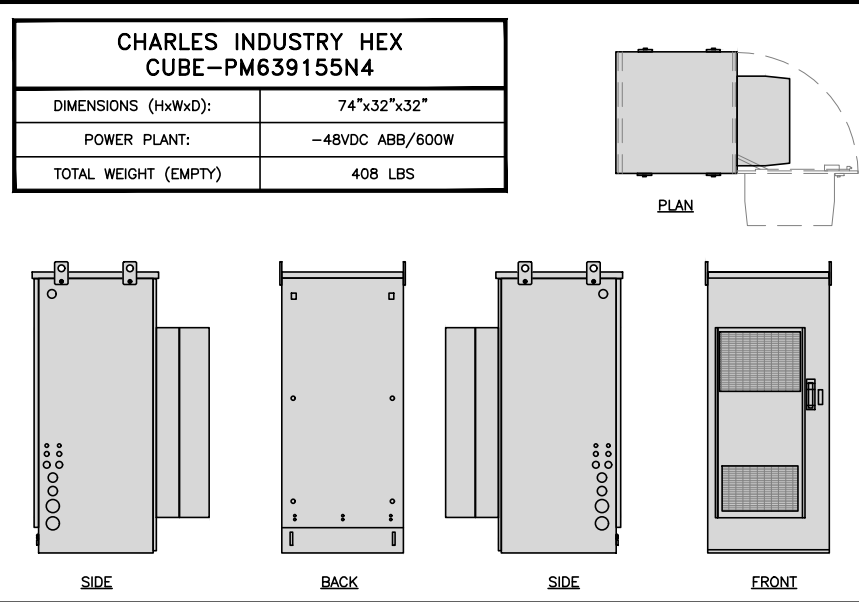

**CABINET DETAIL** NO SCALE 1

**GPS DETAIL** NO SCALE 2

**BREAKER PANEL DETAIL** NO SCALE 3

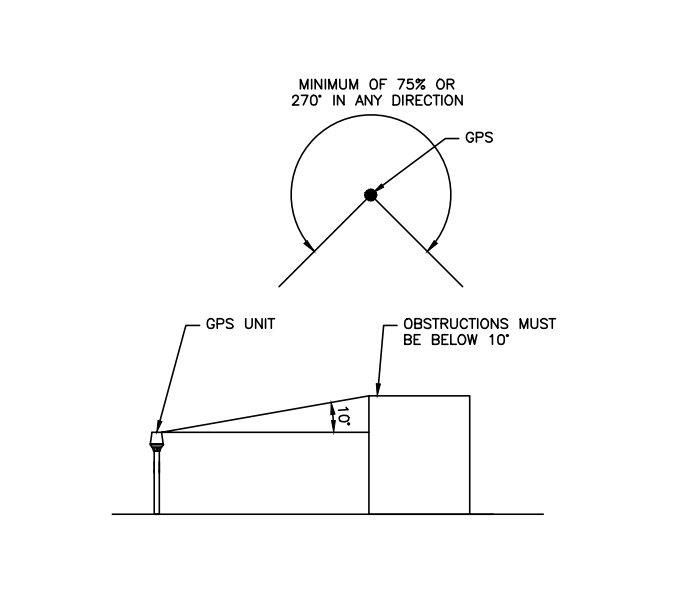
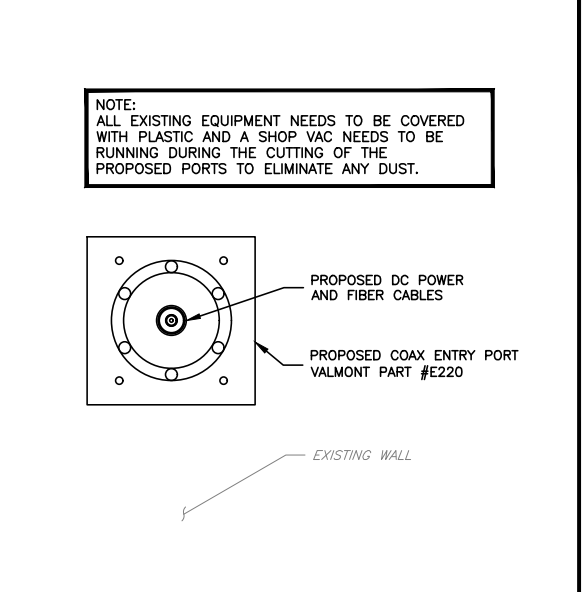
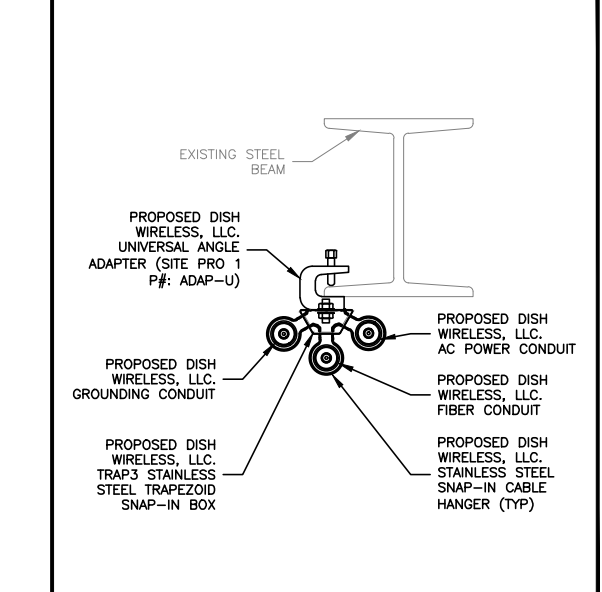
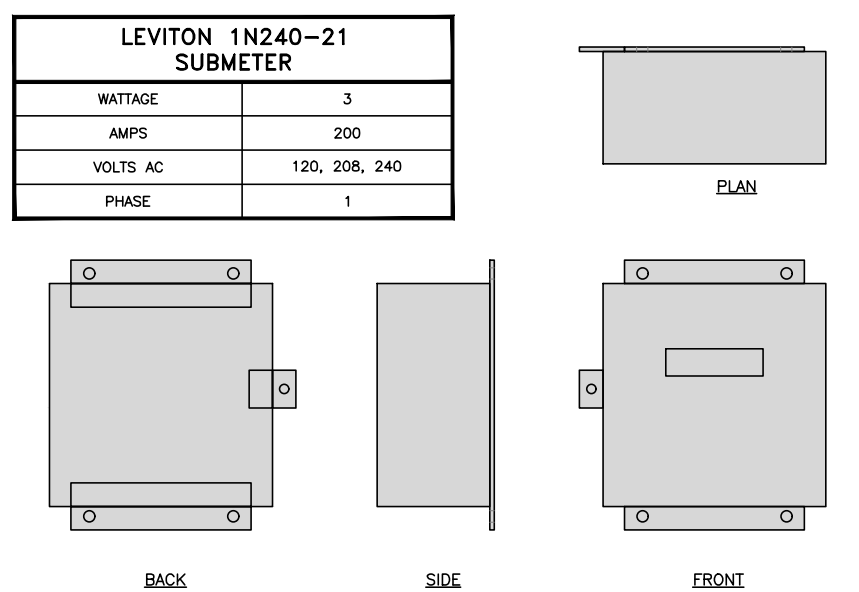

**E-MON D-MON DETAIL** NO SCALE 4

**CABLE MOUNTING DETAIL** NO SCALE 5

**CABLE PORT DETAIL** NO SCALE 6

**GPS MINIMUM SKY VIEW REQUIREMENTS** NO SCALE 7

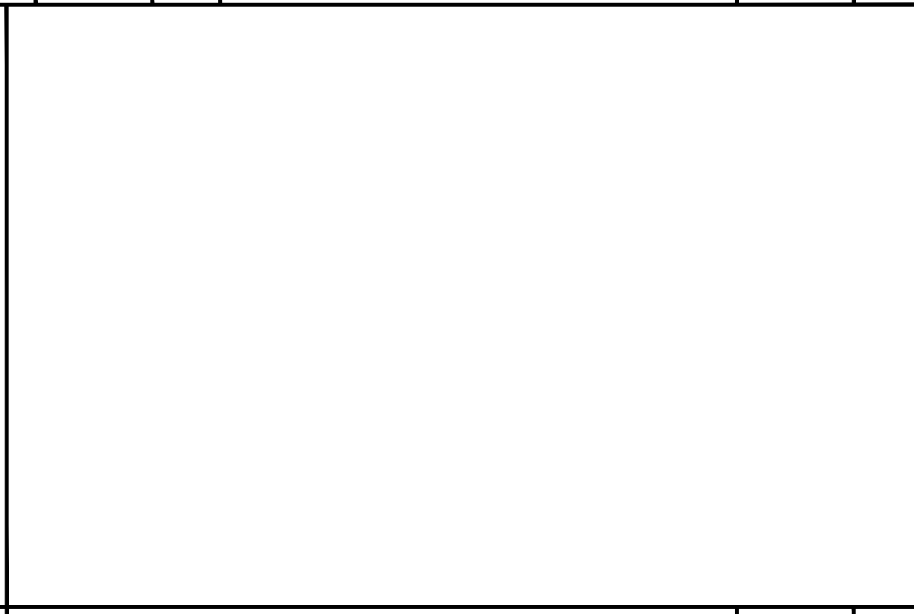
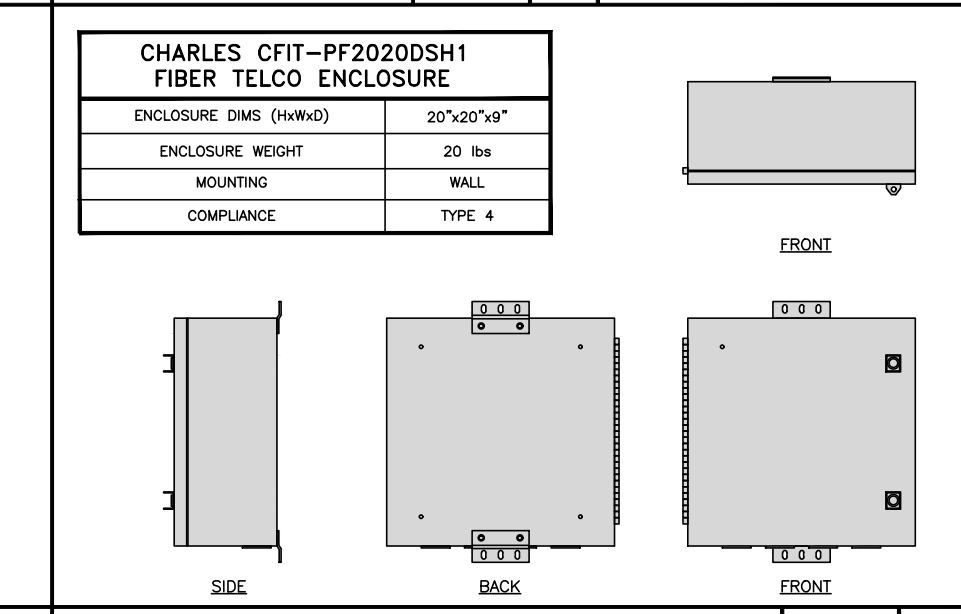
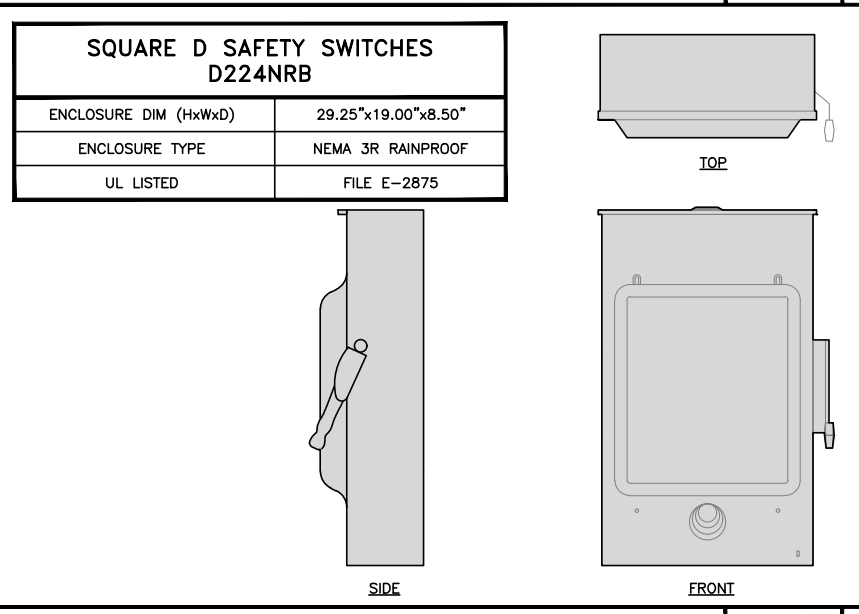

**SAFETY SWITCH DETAIL** NO SCALE 8

**FIBER TELCO ENCLOSURE DETAIL** NO SCALE 9

**NOT USED** NO SCALE 10



IT IS A VIOLATION OF LAW FOR ANY PERSON, UNLESS THEY ARE ACTING UNDER THE DIRECTION OF A LICENSED PROFESSIONAL ENGINEER, TO ALTER THIS DOCUMENT.

DRAWN BY: CWB CHECKED BY: NSB APPROVED BY: DRG  
RFDS REV #: 1

**CONSTRUCTION DOCUMENTS**

SUBMITTALS		
REV	DATE	DESCRIPTION
0	01/20/22	ISSUED FOR CONSTRUCTION
1	06/27/23	UTILITY ROUTES REVISED

A&E PROJECT NUMBER  
**100753**

DISH WIRELESS, LLC.  
PROJECT INFORMATION  
**BOBOS00343A**  
1815 MASSACHUSETTS AVE.  
CAMBRIDGE, MA 02140

SHEET TITLE  
**EQUIPMENT DETAILS**

SHEET NUMBER  
**A-5**

SAMSUNG – MID BAND SFG-ARR3KM01DI_RF4451D-70A	
DIMENSIONS (HxWxD)	15"x15"x8.9"
WEIGHT	61.3 lbs
CONNECTOR TYPE	4.3-10 RF CONNECTOR -48VDC
INPUT VOLTAGE	(-36 to 58 VDC)

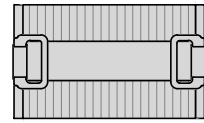

PLAN

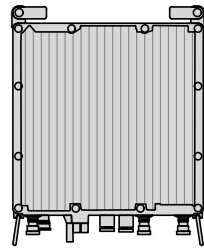

BACK

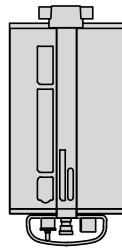

SIDE

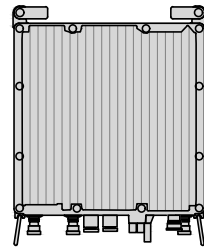

FRONT

RRH DETAIL

NO SCALE

1

SAMSUNG – LOW BAND SFG-ARR3J601DI_RF4450T-71A	
DIMENSIONS (HxWxD)	15"x16.5"x11"
WEIGHT	94.6 lbs
CONNECTOR TYPE	4.3-10 RF CONNECTOR -48VDC
INPUT VOLTAGE	(-36 to 58 VDC)

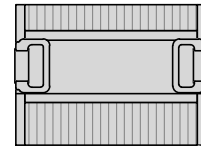

PLAN

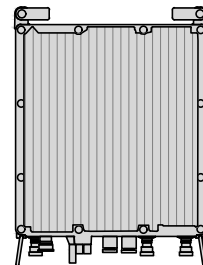

BACK

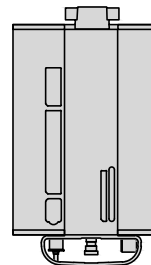

SIDE

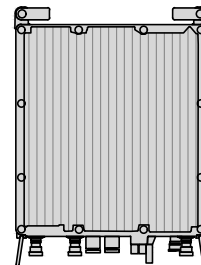

FRONT

RRH DETAIL

NO SCALE

2

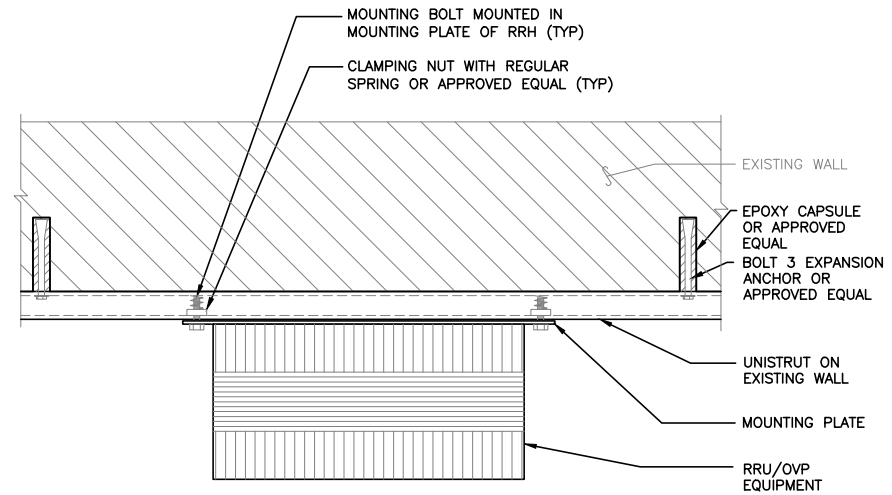

RRH/OVP UNISTRUT WALL MOUNT DETAIL

NO SCALE

3

RAYCAP RDIDC-3045-PF-48 SURGE PROTECTION DEVICE (OVP)	
DIMENSIONS (HxWxD)	18.97"x16.21"x9.64"
WEIGHT	21 lbs

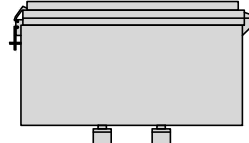

PLAN

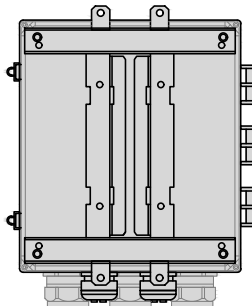

BACK

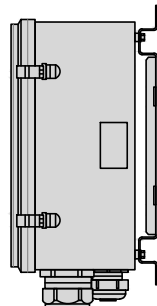

SIDE

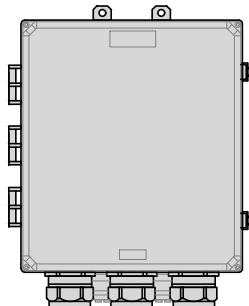

FRONT

SURGE PROTECTION DEVICE DETAIL (OVP)

NO SCALE

4

JMA MX08FRO665-21	
DIMENSIONS (HxWxD)	72.8"x20.0"x8.0"
RF PORTS, CONNECTOR TYPE	8 x 4.3-10 FEMALE
WEIGHT	64.5 lbs
WEIGHT WITH BRACKETS	82.5 lbs

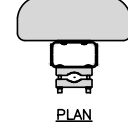

PLAN

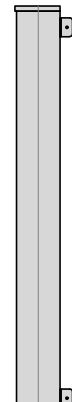

SIDE

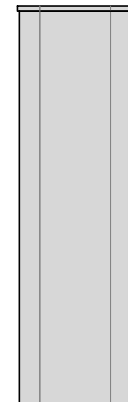

FRONT

ANTENNA DETAIL

NO SCALE

5

COMMSCOPE RT-CB4D ROOFTOP COVER KIT		MOUNTING	NON-PENETRATING
DIMENSIONS (HxWxL)	7"x 11.25"x 96"	INCLUDED PRODUCTS:	RTCB4D.01 CHANNEL (1) MT-F1598 SLEEPERS (3) RTCUH HARDWARE RTHC.01 HOLD-DOWN CLAMPS (6)
WEIGHT/ VOLUME	85.98 LBS		
CABLE RUN (QTY)	4		

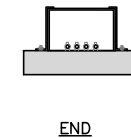

END

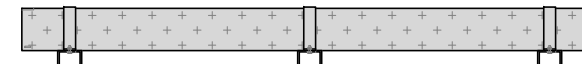

SIDE

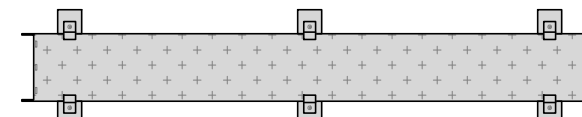

PLAN

ROOFTOP CABLE TRAY DETAIL

NO SCALE

6

JMA ANTENNA MOUNTING BRACKET #91900318	
TOTAL WEIGHT (WITH BRACKETS)	18 lbs (8.18 Kg)
POLE DIAMETER RANGE	2.5 TO 4.5 INCHES

NOTE:  
KIT #91900318: TOP AND BOTTOM BRACKETS FOR 4-, 6-, AND 8-FOOT ANTENNAS  
ANTENNA BRACKET NOT PART OF KIT

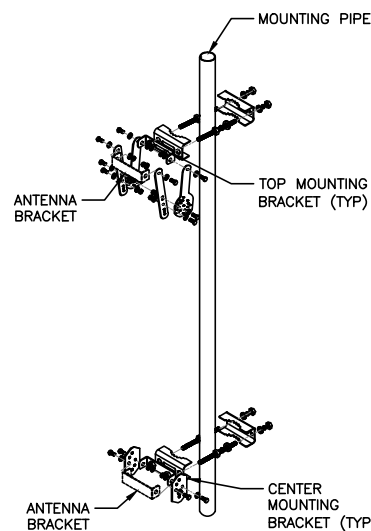

ANTENNA BRACKET DETAIL

NO SCALE

7

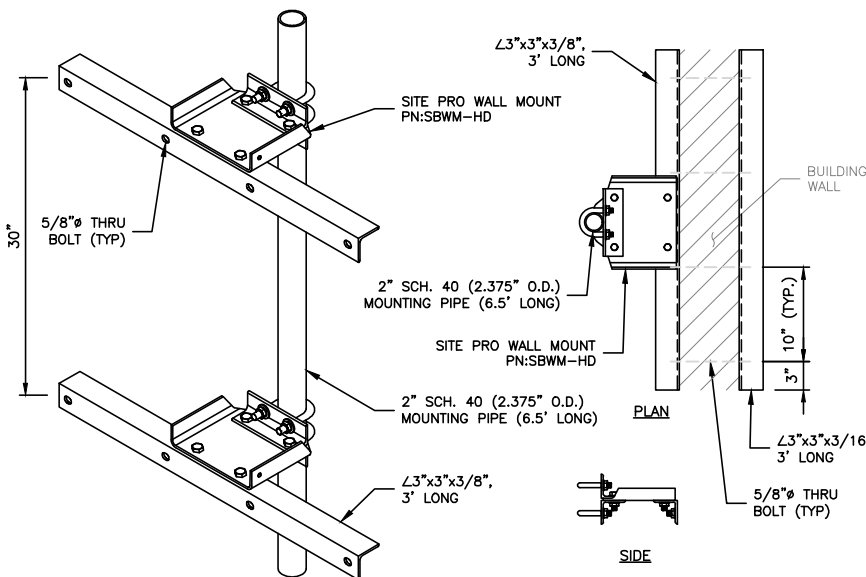

ANTENNA MOUNT DETAIL

NO SCALE

8

NOT USED

NO SCALE

9

**dish**  
wireless.

5701 SOUTH SANTA FE DRIVE  
LITTLETON, CO 80120

**NB+C**  
TOTALLY COMMITTED.

NB+C ENGINEERING SERVICES, LLC.

100 APOLLO DRIVE  
SUITE 303  
CHELMSFORD, MA 01824  
(978) 856-8308



IT IS A VIOLATION OF LAW FOR ANY PERSON, UNLESS THEY ARE ACTING UNDER THE DIRECTION OF A LICENSED PROFESSIONAL ENGINEER, TO ALTER THIS DOCUMENT.

DRAWN BY: CHECKED BY: APPROVED BY:  
CWE NSB DRG

RFDS REV #: 1

CONSTRUCTION DOCUMENTS

SUBMITTALS		
REV	DATE	DESCRIPTION
0	01/20/22	ISSUED FOR CONSTRUCTION
1	06/27/23	UTILITY ROUTES REVISED

A&E PROJECT NUMBER  
100753

DISH WIRELESS, LLC.  
PROJECT INFORMATION  
BOBOS00343A

1815 MASSACHUSETTS AVE.  
CAMBRIDGE, MA 02140

SHEET TITLE  
EQUIPMENT DETAILS

SHEET NUMBER

A-6



**NOTE**

CONTRACTOR SHALL FIELD VERIFY ALL DIMENSIONS.

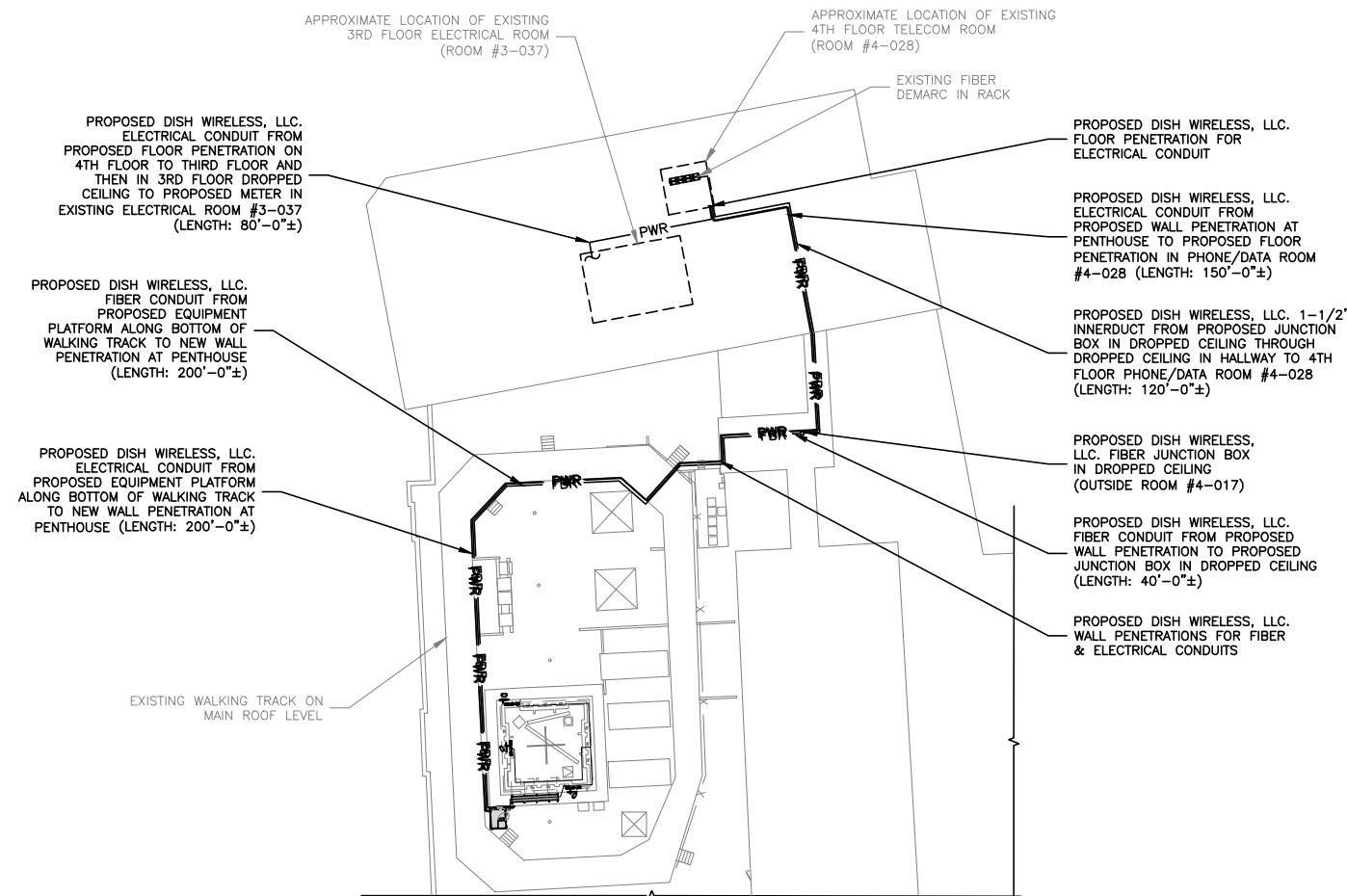

**UTILITY ROUTE PLAN**

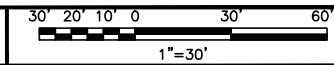

1

**NOTES**

1. CONTRACTOR SHALL FIELD VERIFY ALL DIMENSIONS.

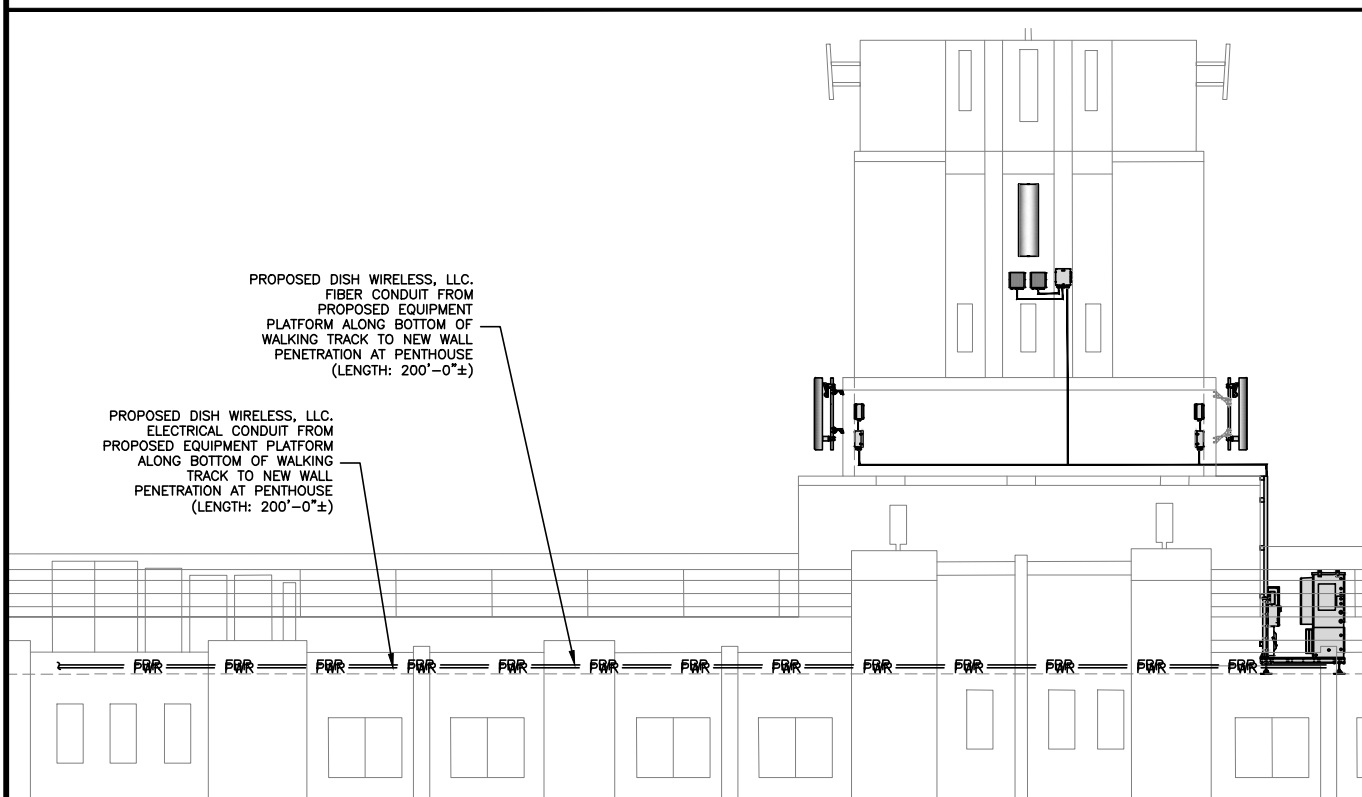

**UTILITY ROUTE ELEVATION**

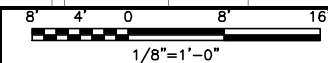

3

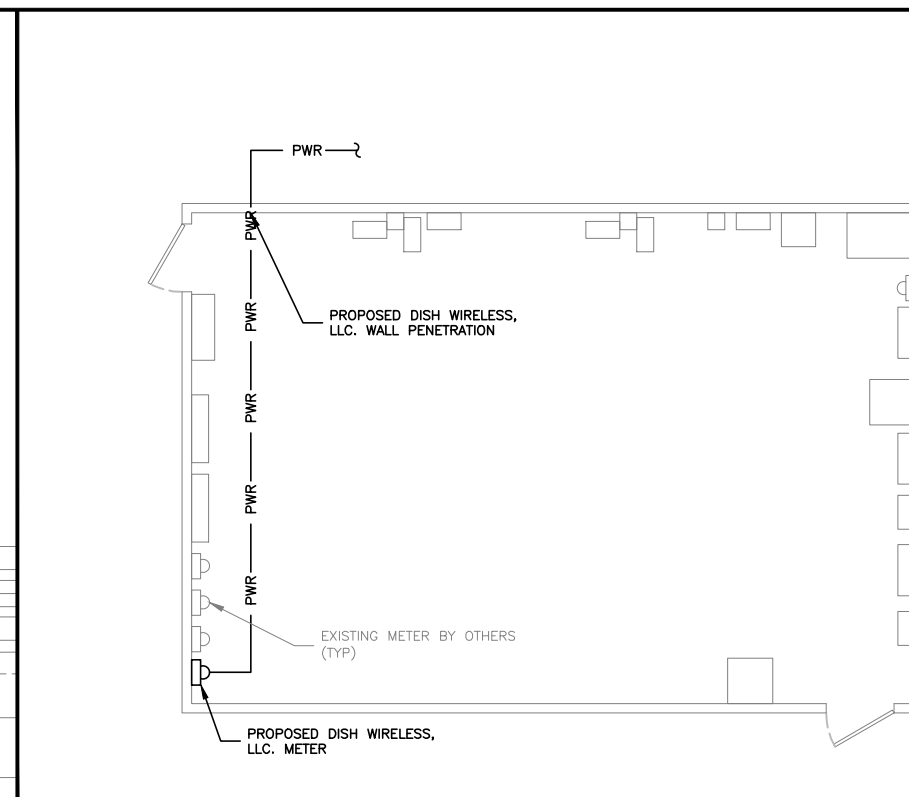

**ELECTRICAL ROOM PLAN (3RD FLOOR)**

NO SCALE

4



5701 SOUTH SANTA FE DRIVE  
LITTLETON, CO 80120



**NB+C ENGINEERING SERVICES, LLC.**

100 APOLLO DRIVE  
SUITE 303  
CHELMSFORD, MA 01824  
(978) 856-8308



IT IS A VIOLATION OF LAW FOR ANY PERSON, UNLESS THEY ARE ACTING UNDER THE DIRECTION OF A LICENSED PROFESSIONAL ENGINEER, TO ALTER THIS DOCUMENT.

DRAWN BY: CHECKED BY: APPROVED BY:  
CWE NSB DRG

RFDS REV #: 1

**CONSTRUCTION DOCUMENTS**

SUBMITTALS		
REV	DATE	DESCRIPTION
0	01/20/22	ISSUED FOR CONSTRUCTION
1	06/27/23	UTILITY ROUTES REVISED

A&E PROJECT NUMBER  
**100753**

DISH WIRELESS, LLC.  
PROJECT INFORMATION  
**BOBOS00343A**

1815 MASSACHUSETTS AVE.  
CAMBRIDGE, MA 02140

SHEET TITLE  
**ELECTRICAL/FIBER ROUTE PLAN AND NOTES**

SHEET NUMBER

**E-1**

DC POWER WIRING SHALL BE COLOR CODED AT EACH END FOR IDENTIFYING +24V AND -48V CONDUCTORS. RED MARKINGS SHALL IDENTIFY +24V AND BLUE MARKINGS SHALL IDENTIFY -48V.

- CONTRACTOR SHALL INSPECT THE EXISTING CONDITIONS PRIOR TO SUBMITTING A BID. ANY QUESTIONS ARISING DURING THE BID PERIOD IN REGARDS TO THE CONTRACTOR'S FUNCTIONS, THE SCOPE OF WORK, OR ANY OTHER ISSUE RELATED TO THIS PROJECT SHALL BE BROUGHT UP DURING THE BID PERIOD WITH THE PROJECT MANAGER FOR CLARIFICATION, NOT AFTER THE CONTRACT HAS BEEN AWARDED.
- ALL ELECTRICAL WORK SHALL BE DONE IN ACCORDANCE WITH CURRENT NATIONAL ELECTRICAL CODES AND ALL STATE AND LOCAL CODES, LAWS, AND ORDINANCES. PROVIDE ALL COMPONENTS AND WIRING SIZES AS REQUIRED TO MEET NEC STANDARDS.
- LOCATION OF EQUIPMENT, CONDUIT AND DEVICES SHOWN ON THE DRAWINGS ARE APPROXIMATE AND SHALL BE COORDINATED WITH FIELD CONDITIONS PRIOR TO CONSTRUCTION.
- CONDUIT ROUGH-IN SHALL BE COORDINATED WITH THE MECHANICAL EQUIPMENT TO AVOID LOCATION CONFLICTS. VERIFY WITH THE MECHANICAL EQUIPMENT CONTRACTOR AND COMPLY AS REQUIRED.
- CONTRACTOR SHALL PROVIDE ALL BREAKERS, CONDUITS AND CIRCUITS AS REQUIRED FOR A COMPLETE SYSTEM.
- CONTRACTOR SHALL PROVIDE PULL BOXES AND JUNCTION BOXES AS REQUIRED BY THE NEC ARTICLE 314.
- CONTRACTOR SHALL PROVIDE ALL STRAIN RELIEF AND CABLE SUPPORTS FOR ALL CABLE ASSEMBLIES. INSTALLATION SHALL BE IN ACCORDANCE WITH MANUFACTURER'S SPECIFICATIONS AND RECOMMENDATIONS.
- ALL DISCONNECTS AND CONTROLLING DEVICES SHALL BE PROVIDED WITH ENGRAVED PHENOLIC NAMEPLATES INDICATING EQUIPMENT CONTROLLED, BRANCH CIRCUITS INSTALLED ON, AND PANEL FIELD LOCATIONS FED FROM.
- INSTALL AN EQUIPMENT GROUNDING CONDUCTOR IN ALL CONDUITS PER THE SPECIFICATIONS AND NEC 250. THE EQUIPMENT GROUNDING CONDUCTORS SHALL BE BONDED AT ALL JUNCTION BOXES, PULL BOXES, AND ALL DISCONNECT SWITCHES, AND EQUIPMENT CABINETS.
- ALL NEW MATERIAL SHALL HAVE A U.L. LABEL.
- PANEL SCHEDULE LOADING AND CIRCUIT ARRANGEMENTS REFLECT POST-CONSTRUCTION EQUIPMENT.
- CONTRACTOR SHALL BE RESPONSIBLE FOR AS-BUILT PANEL SCHEDULE AND SITE DRAWINGS.

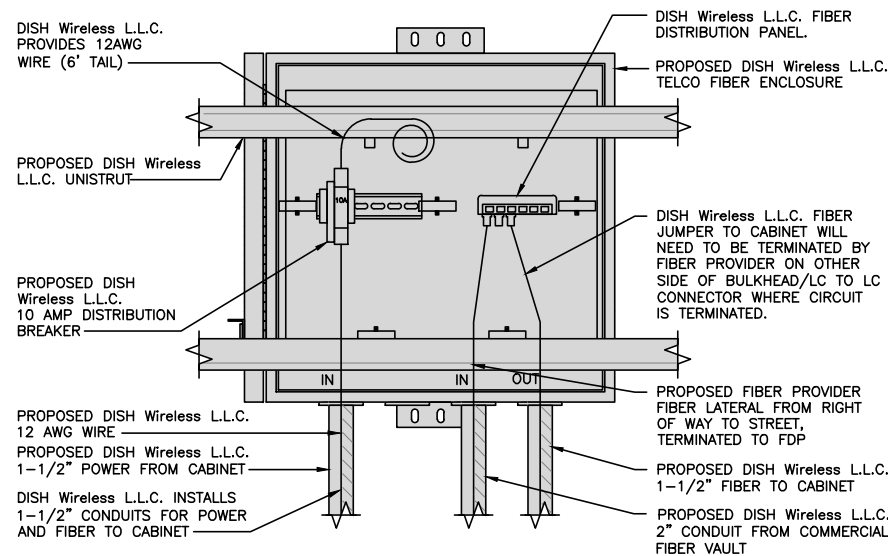

**DARK TELCO BOX - INTERIOR WIRING LAYOUT**

NO SCALE 2

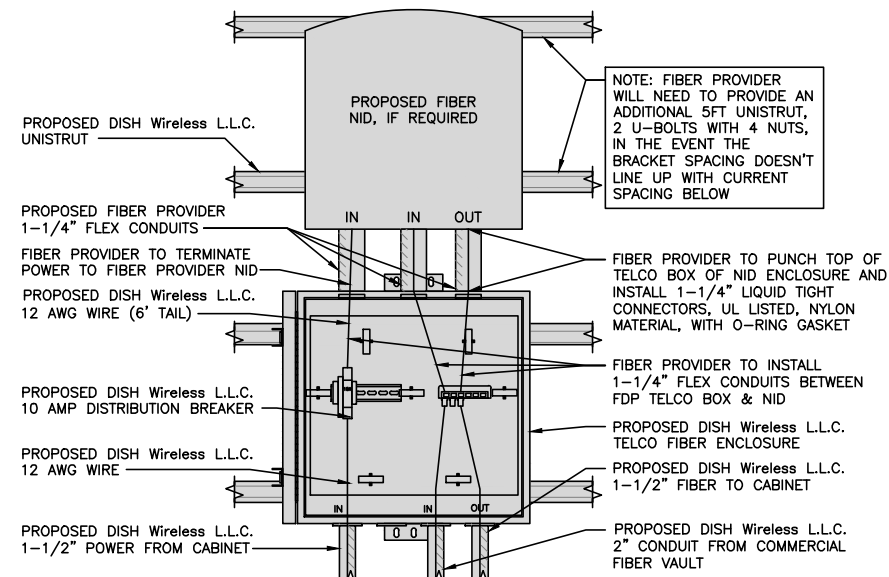

**LIT TELCO BOX - INTERIOR WIRING LAYOUT (OPTIONAL)**

NO SCALE 3

**ELECTRICAL NOTES**

NO SCALE 1

**NOT USED**

NO SCALE 4

**NOT USED**

NO SCALE 5

**NOT USED**

NO SCALE 6

**NOT USED**

NO SCALE 7

**NOT USED**

NO SCALE 8



5701 SOUTH SANTA FE DRIVE  
LITTLETON, CO 80120



**NB+C ENGINEERING SERVICES, LLC.**

100 APOLLO DRIVE  
SUITE 303  
CHELMSFORD, MA 01824  
(978) 856-8308



IT IS A VIOLATION OF LAW FOR ANY PERSON, UNLESS THEY ARE ACTING UNDER THE DIRECTION OF A LICENSED PROFESSIONAL ENGINEER, TO ALTER THIS DOCUMENT.

DRAWN BY: CWE CHECKED BY: NSB APPROVED BY: DRG

RFDS REV #: 1

**CONSTRUCTION DOCUMENTS**

SUBMITTALS		
REV	DATE	DESCRIPTION
0	01/20/22	ISSUED FOR CONSTRUCTION
1	06/27/23	UTILITY ROUTES REVISED

A&E PROJECT NUMBER  
**100753**

DISH WIRELESS, LLC.  
PROJECT INFORMATION  
**BOBOS00343A**

1815 MASSACHUSETTS AVE.  
CAMBRIDGE, MA 02140

SHEET TITLE  
**ELECTRICAL  
DETAILS**

SHEET NUMBER  
**E-2**

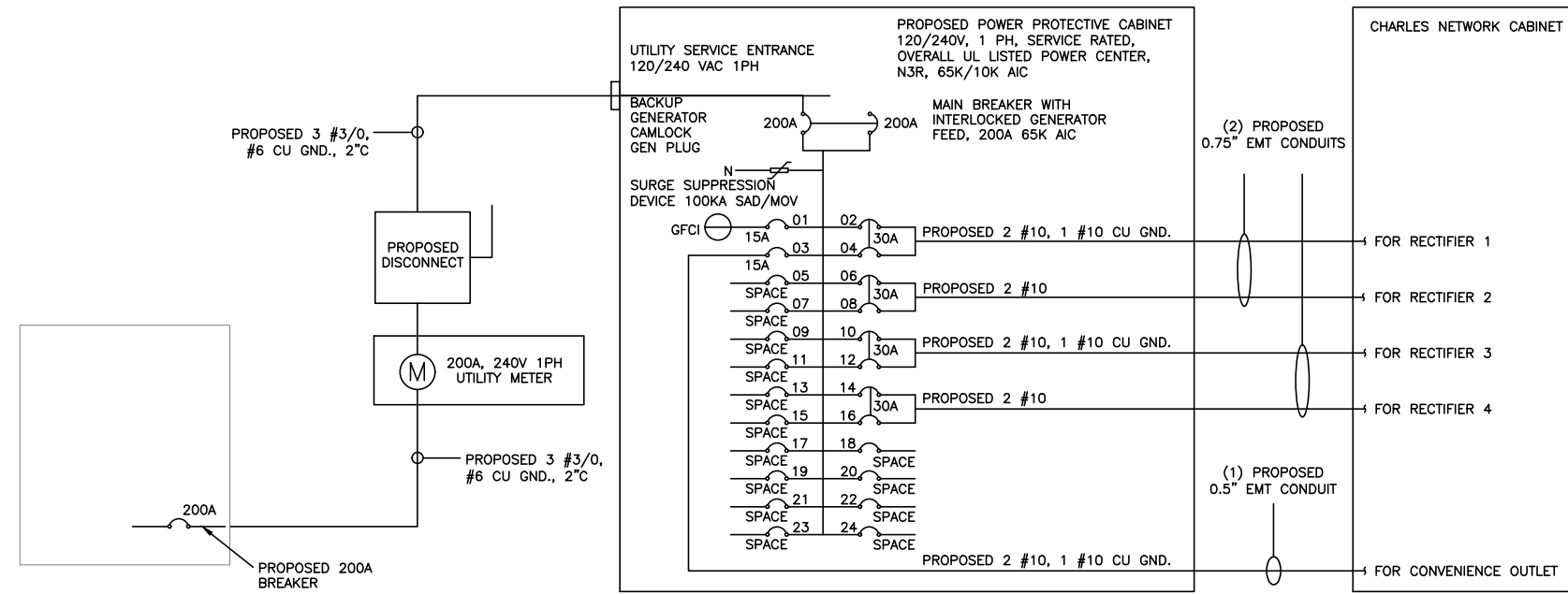

**NOTES**

THERE ARE A TOTAL OF (6) CURRENT CARRYING CONDUCTORS IN A SINGLE CONDUIT. ADJUSTABLE FACTOR OF 80% PER NEC TABLE 310.15(B)(3)(a) SHALL APPLY.

#10 FOR 15A/1P BREAKER:  $0.8 \times 40A = 32.0A$   
#8 FOR 35A-40A/2P BREAKER:  $0.8 \times 55A = 44.0A$

CONDUIT SIZING: ASSUME 1.5" EMT AT 40% FILL PER NEC 358, TABLE 4 - 0.814A SQ. IN AREA

WIRES: USING THWN-2, CU. (INCLUDING 3 GROUND WIRES)

#4 -  $0.0824 \text{ SQ. IN} \times 4 = 0.3296 \text{ SQ. IN}$   
#8 -  $0.0366 \text{ SQ. IN} \times 2 = 0.0732 \text{ SQ. IN}$   
#10 -  $0.0211 \text{ SQ. IN} \times 2 = 0.0422 \text{ SQ. IN} < \text{GROUND}$   
#12 -  $0.0133 \text{ SQ. IN} \times 1 = 0.0133 \text{ SQ. IN} < \text{GROUND}$

TOTAL = 0.4583 SQ. IN

1.5" EMT CONDUIT IS ADEQUATE TO HANDLE THE TOTAL OR (8) WIRES, INCLUDING GROUND WIRE, AS INDICATED ABOVE.

CONDUIT SIZING: ASSUME 2.0" EMT AT 40% FILL PER NEC 352, TABLE 4 - 1.216A SQ. IN AREA

WIRES: USING THHN, CU. (INCLUDING 2 GROUND WIRES)

#3/0 -  $0.1318 \text{ SQ. IN} \times 3 = 0.3954 \text{ SQ. IN}$   
#2 -  $0.0521 \text{ SQ. IN} \times 1 = 0.0521 \text{ SQ. IN}$

TOTAL = 0.4475 SQ. IN

2.0" EMT CONDUIT IS ADEQUATE TO HANDLE THE TOTAL OR (3) WIRES, INCLUDING GROUND WIRE, AS INDICATED ABOVE.



5701 SOUTH SANTA FE DRIVE  
LITTLETON, CO 80120



**NB+C ENGINEERING SERVICES, LLC.**

100 APOLLO DRIVE  
SUITE 303  
CHELMSFORD, MA 01824  
(978) 856-8308

(CHARLES ALPHA CORDEX DC PLANT) WITH STAND ALONE METER 120V240V 1PH SOURCE

NO SCALE 1

PROPOSED CHARLES PANEL SCHEDULE										
LOAD SERVED	VOLT AMPS (WATTS)		TRIP	CKT #	PHASE	CKT #	TRIP	VOLT AMPS (WATTS)		LOAD SERVED
	L1	L2						L1	L2	
PPC GFCI OUTLET	180	180	15A	1	A	2	30A	2880	2880	ABB/GE INFINITY RECTIFIER 1
CHARLES GFCI OUTLET			15A	3	B	4				
-SPACE-				5	A	6	30A	2880	2880	ABB/GE INFINITY RECTIFIER 2
-SPACE-				7	B	8				
-SPACE-				9	A	10	30A	2880	2880	ABB/GE INFINITY RECTIFIER 3
-SPACE-				11	B	12				
-SPACE-				13	A	14	30A	2880	2880	ABB/GE INFINITY RECTIFIER 4
-SPACE-				15	B	16				
-SPACE-				17	A	18				-SPACE-
-SPACE-				19	B	20				-SPACE-
-SPACE-				21	A	22				-SPACE-
-SPACE-				23	B	24				-SPACE-
VOLTAGE AMPS	180	180						11520	11520	
200A MCB, 1φ, 24 SPACE, 120/240V				L1	L2					
MB RATING: 65,000 AIC				11700	11700			VOLTAGE AMPS		
				98	98			AMPS		
				98				MAX AMPS		
				123				MAX 125%		

PANEL SCHEDULE

(CHARLES ALPHA CORDEX DC PLANT) WITH STAND ALONE METER 120V240V 1PH SOURCE

NO SCALE 2

NOT USED

NO SCALE 3

NOT USED

NO SCALE 4



IT IS A VIOLATION OF LAW FOR ANY PERSON, UNLESS THEY ARE ACTING UNDER THE DIRECTION OF A LICENSED PROFESSIONAL ENGINEER, TO ALTER THIS DOCUMENT.

DRAWN BY: CWB CHECKED BY: NSB APPROVED BY: DRG

RFDS REV #: 1

**CONSTRUCTION DOCUMENTS**

SUBMITTALS		
REV	DATE	DESCRIPTION
0	01/20/22	ISSUED FOR CONSTRUCTION
1	06/27/23	UTILITY ROUTES REVISED

A&E PROJECT NUMBER  
100753

DISH WIRELESS, LLC.  
PROJECT INFORMATION  
BOBOS00343A

1815 MASSACHUSETTS AVE.  
CAMBRIDGE, MA 02140

SHEET TITLE  
ELECTRICAL ONE-LINE, FAULT  
CALCS & PANEL SCHEDULE

SHEET NUMBER  
**E-3**



5701 SOUTH SANTA FE DRIVE  
LITTLETON, CO 80120



NB+C ENGINEERING SERVICES, LLC.

100 APOLLO DRIVE  
SUITE 303  
CHELMSFORD, MA 01824  
(978) 856-8308



IT IS A VIOLATION OF LAW FOR ANY PERSON, UNLESS THEY ARE ACTING UNDER THE DIRECTION OF A LICENSED PROFESSIONAL ENGINEER, TO ALTER THIS DOCUMENT.

DRAWN BY:	CHECKED BY:	APPROVED BY:
CWE	NSB	DRG

RFDS REV #: 1

**CONSTRUCTION DOCUMENTS**

SUBMITTALS		
REV	DATE	DESCRIPTION
0	01/20/22	ISSUED FOR CONSTRUCTION
1	06/27/23	UTILITY ROUTES REVISED

A&E PROJECT NUMBER  
**100753**

DISH WIRELESS, LLC.  
PROJECT INFORMATION  
**BOBOS00343A**

1815 MASSACHUSETTS AVE.  
CAMBRIDGE, MA 02140

SHEET TITLE  
**GROUNDING PLANS AND NOTES**

SHEET NUMBER

**G-1**

- EXOTHERMIC CONNECTION
- MECHANICAL CONNECTION
- GROUND BUS BAR
- GROUND ROD
- TEST GROUND ROD WITH INSPECTION SLEEVE
- #6 AWG STRANDED & INSULATED
- - - - - #2 AWG SOLID COPPER TINNED
- ▲ BUSS BAR INSULATOR

**GROUNDING LEGEND**

- GROUNDING IS SHOWN DIAGRAMMATICALLY ONLY.
- CONTRACTOR SHALL GROUND ALL EQUIPMENT AS A COMPLETE SYSTEM. GROUNDING SHALL BE IN COMPLIANCE WITH NEC SECTION 250 AND DISH WIRELESS, LLC. GROUNDING AND BONDING REQUIREMENTS AND MANUFACTURER'S SPECIFICATIONS.
- ALL GROUND CONDUCTORS SHALL BE COPPER; NO ALUMINUM CONDUCTORS SHALL BE USED.
- NO EXOTHERMIC WELDING ON ROOFTOP

**GROUNDING ROOFTOP KEY NOTES**

- EXTERIOR GROUND RING:** #2 AWG SOLID COPPER, BURIED AT A DEPTH OF AT LEAST 30 INCHES BELOW GRADE, OR 6 INCHES BELOW THE FROST LINE AND APPROXIMATELY 24 INCHES FROM THE EXTERIOR WALL OR FOOTING.
- ROOFTOP GROUND SYSTEM:** THE GROUND SYSTEM USING MINIMUM #2 AWG SOLID COPPER CONDUCTORS.
- INTERIOR GROUND RING:** #2 AWG STRANDED GREEN INSULATED COPPER CONDUCTOR EXTENDED AROUND THE PERIMETER OF THE EQUIPMENT AREA. ALL NON-TELECOMMUNICATIONS RELATED METALLIC OBJECTS FOUND WITHIN A SITE SHALL BE GROUNDED TO THE INTERIOR GROUND RING WITH #6 AWG STRANDED GREEN INSULATED CONDUCTOR.
- BOND TO INTERIOR GROUND RING:** #2 AWG SOLID TINNED COPPER WIRE PRIMARY BONDS SHALL BE PROVIDED AT LEAST AT FOUR POINTS ON THE INTERIOR GROUND RING, LOCATED AT THE CORNERS OF THE BUILDING OR ROOM.
- GROUND ROD:** UL LISTED COPPER CLAD STEEL. MINIMUM 1/2" DIAMETER BY EIGHT FEET LONG. GROUND RODS SHALL BE INSTALLED WITH INSPECTION SLEEVES. GROUND RODS SHALL BE DRIVEN TO THE DEPTH OF GROUND RING CONDUCTOR.
- CELL REFERENCE GROUND BAR (CRGB):** POINT OF GROUND REFERENCE FOR ALL COMMUNICATIONS EQUIPMENT FRAMES. ALL BONDS ARE MADE WITH #2 AWG UNLESS NOTED OTHERWISE STRANDED GREEN INSULATED COPPER CONDUCTORS. BOND TO COMMON BUILDING GROUND SYSTEM WITH (2) #2 SOLID TINNED COPPER CONDUCTORS.
- HATCH PLATE GROUND BAR:** BOND TO THE COMMON BUILDING GROUND SYSTEM WITH TWO #2 AWG STRANDED GREEN INSULATED COPPER CONDUCTORS. WHEN A HATCH-PLATE AND A CELL REFERENCE GROUND BAR ARE BOTH PRESENT, THE CRGB MUST BE CONNECTED TO THE HATCH-PLATE AND TO THE INTERIOR GROUND RING USING (2) TWO #2 AWG STRANDED GREEN INSULATED COPPER CONDUCTORS EACH.
- EXTERIOR CABLE ENTRY PORT GROUND BARS:** LOCATED AT THE ENTRANCE TO THE CELL SITE ROOM. BOND TO GROUND RING WITH A #2 AWG SOLID TINNED COPPER CONDUCTORS WITH MECHANICAL CONNECTIONS.
- TELCO GROUND BAR:** BOND TO BOTH CELL REFERENCE GROUND BAR OR EXTERIOR GROUND RING.
- FRAME BONDING:** THE BONDING POINT FOR TELECOM EQUIPMENT FRAMES SHALL BE THE GROUND BUS THAT IS NOT ISOLATED FROM THE EQUIPMENTS METAL FRAMEWORK.
- INTERIOR UNIT BONDS:** METAL FRAMES, CABINETS AND INDIVIDUAL METALLIC UNITS LOCATED WITH THE AREA OF THE INTERIOR GROUND RING REQUIRE A #6 AWG STRANDED GREEN INSULATED COPPER BOND TO THE INTERIOR GROUND RING.
- FENCE AND GATE GROUNDING:** METAL FENCES SHALL BE BONDED TO THE COMMON BUILDING GROUND SYSTEM WITH A #2 AWG SOLID TINNED COPPER CONDUCTOR AT AN INTERVAL NOT EXCEEDING 25 FEET. BONDS SHALL BE MADE AT EACH GATE POST AND ACROSS GATE OPENINGS.
- EXTERIOR UNIT BONDS:** METALLIC OBJECTS, EXTERNAL TO OR MOUNTED TO THE BUILDING, SHALL BE BONDED TO THE COMMON BUILDING GROUND SYSTEM. USING #2 TINNED SOLID COPPER WIRE
- ICE BRIDGE SUPPORTS:** EACH ICE BRIDGE LEG SHALL BE BONDED TO THE GROUND RING WITH #2 AWG BARE TINNED COPPER CONDUCTOR. PROVIDE EXOTHERMIC WELDS AT BOTH THE ICE BRIDGE LEG AND BURIED GROUND RING.
- DURING ALL DC POWER SYSTEM CHANGES INCLUDING DC SYSTEM CHANGE OUTS, RECTIFIER REPLACEMENTS OR ADDITIONS, BREAKER DISTRIBUTION CHANGES, BATTERY ADDITIONS, BATTERY REPLACEMENTS AND INSTALLATIONS OR CHANGES TO DC CONVERTER SYSTEMS IT SHALL BE REQUIRED THAT SERVICE CONTRACTORS VERIFY ALL DC POWER SYSTEMS ARE EQUIPPED WITH A MASTER DC SYSTEM RETURN GROUND CONDUCTOR FROM THE DC POWER SYSTEM COMMON RETURN BUS DIRECTLY CONNECTED TO THE CELL SITE REFERENCE GROUND BAR**
- ROOFTOP COLLECTOR BUSS BAR IS TO BE MECHANICALLY BONDED TO COMMON BUILDING GROUND SYSTEM. REFER TO DISH WIRELESS, LLC. GROUNDING NOTES.**

APPROXIMATE LOCATION OF EXISTING MAIN WATER SERVICE ENTRANCE IN LOWER LEVEL

PROPOSED DISH WIRELESS, LLC. GROUNDING CONDUIT FROM PROPOSED EQUIPMENT PLATFORM ALONG BOTTOM OF WALKING TRACK TO EXISTING MAIN WATER SERVICE IN LOWER LEVEL (LENGTH: 130'-0"±)



**GROUNDING PLAN**

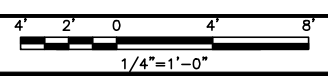

1

**GROUNDING KEY NOTES**

NO SCALE

2



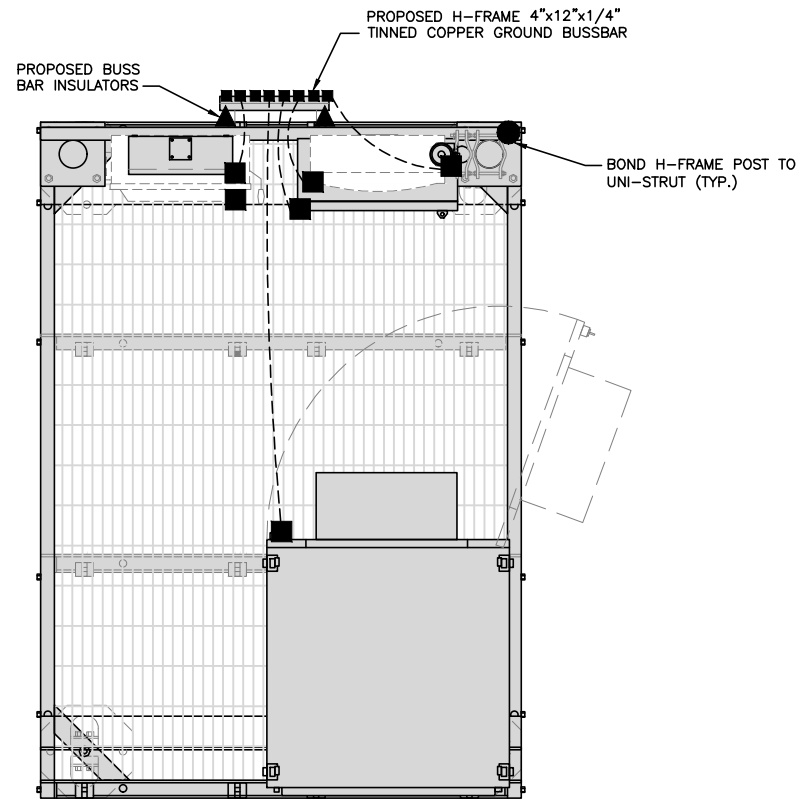

TYPICAL ROOFTOP EQUIPMENT GROUNDING PLAN

NO SCALE 1

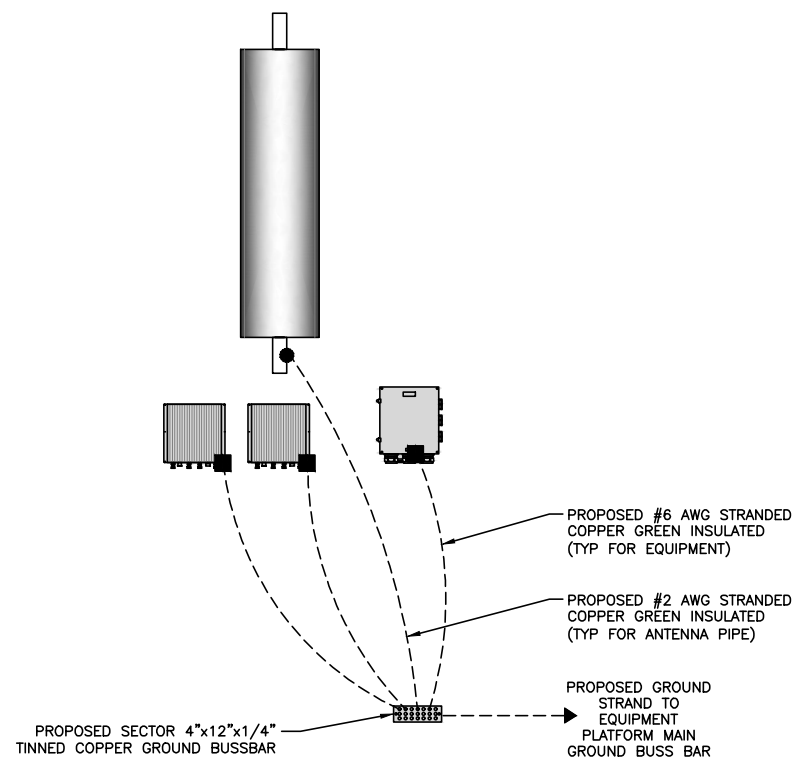

ANTENNA GROUNDING PLAN

NO SCALE 2

NOTE

EQUIPMENT CABINET OMITTED FOR CLARITY

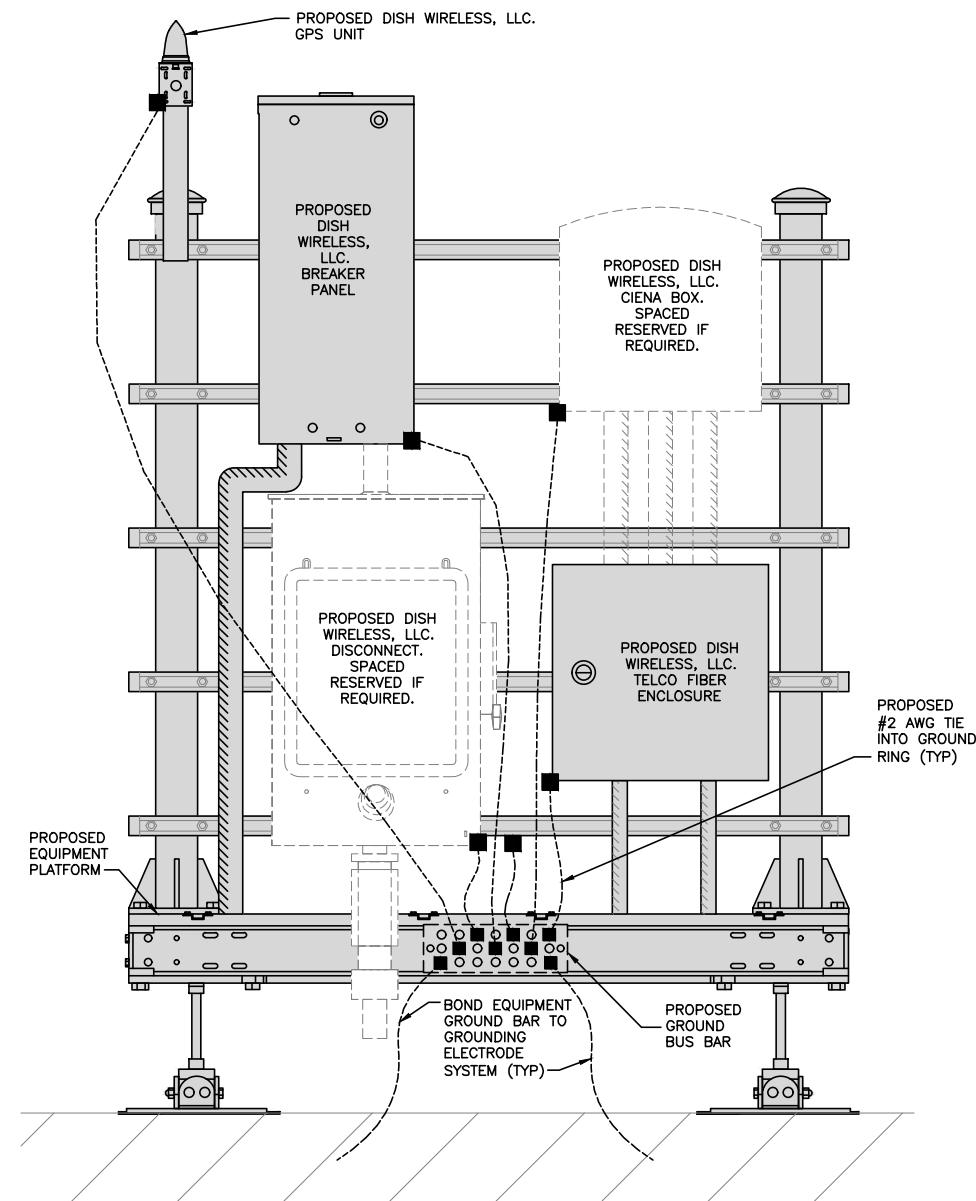

H-FRAME GROUNDING DETAIL

NO SCALE 3



5701 SOUTH SANTA FE DRIVE  
LITTLETON, CO 80120



NB+C ENGINEERING SERVICES, LLC.

100 APOLLO DRIVE  
SUITE 303  
CHELMSFORD, MA 01824  
(978) 856-8308



IT IS A VIOLATION OF LAW FOR ANY PERSON,  
UNLESS THEY ARE ACTING UNDER THE DIRECTION  
OF A LICENSED PROFESSIONAL ENGINEER,  
TO ALTER THIS DOCUMENT.

DRAWN BY: CHECKED BY: APPROVED BY:  
CWE NSB DRG

RFDS REV #: 1

CONSTRUCTION DOCUMENTS

SUBMITTALS		
REV	DATE	DESCRIPTION
0	01/20/22	ISSUED FOR CONSTRUCTION
1	06/27/23	UTILITY ROUTES REVISED

A&E PROJECT NUMBER  
100753

DISH WIRELESS, LLC.  
PROJECT INFORMATION  
BOBOS00343A  
1815 MASSACHUSETTS AVE.  
CAMBRIDGE, MA 02140

SHEET TITLE  
GROUNDING DETAILS

SHEET NUMBER  
G-2

1. EXOTHERMIC WELD (2) TWO, #2 AWG BARE TINNED SOLID COPPER CONDUCTORS TO GROUND BAR. ROUTE CONDUCTORS TO BURIED GROUND RING AND PROVIDE PARALLEL EXOTHERMIC WELD.
2. ALL EXTERIOR GROUNDING HARDWARE SHALL BE STAINLESS STEEL 3/8" DIAMETER OR LARGER. ALL HARDWARE 18-8 STAINLESS STEEL INCLUDING LOCK WASHERS, COAT ALL SURFACES WITH AN ANTI-OXIDANT COMPOUND BEFORE MATING.
3. FOR GROUND BOND TO STEEL ONLY: COAT ALL SURFACES WITH AN ANTI-OXIDANT COMPOUND BEFORE MATING.
4. DO NOT INSTALL CABLE GROUNDING KIT AT A BEND AND ALWAYS DIRECT GROUND CONDUCTOR DOWN TO GROUNDING BUS.
5. NUT & WASHER SHALL BE PLACED ON THE FRONT SIDE OF THE GROUND BAR AND BOLTED ON THE BACK SIDE.
6. ALL GROUNDING PARTS AND EQUIPMENT TO BE SUPPLIED AND INSTALLED BY CONTRACTOR.
7. THE CONTRACTOR SHALL BE RESPONSIBLE FOR INSTALLING ADDITIONAL GROUND BAR AS REQUIRED.
8. ENSURE THE WIRE INSULATION TERMINATION IS WITHIN 1/8" OF THE BARREL (NO SHINERS).

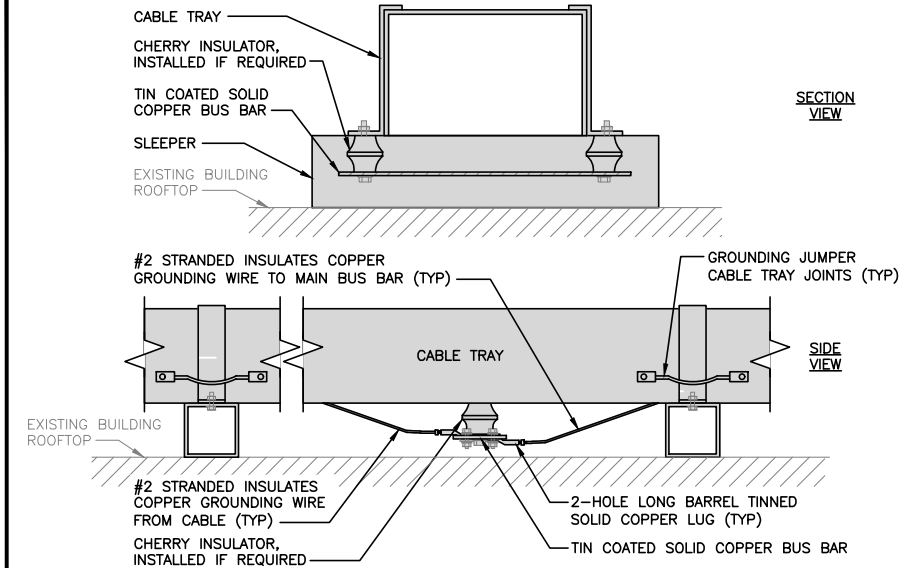
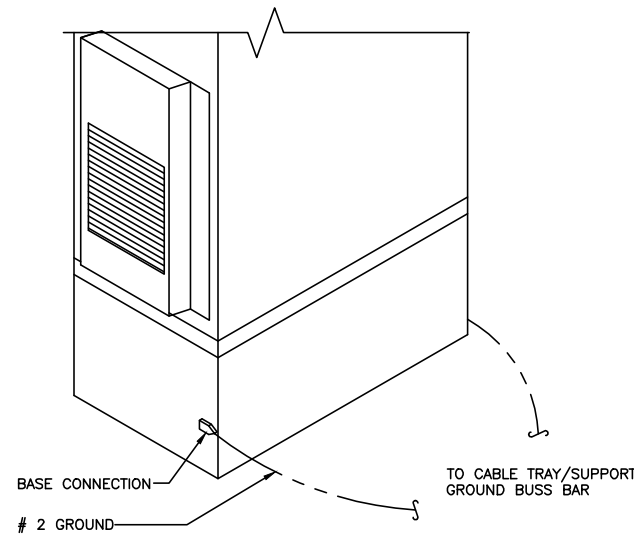

TYPICAL GROUNDING NOTES

NO SCALE 1

OUTDOOR CABINET GROUNDING

NO SCALE 2

TYPICAL CABLE TRAY GROUND BUSS BAR

NO SCALE 3

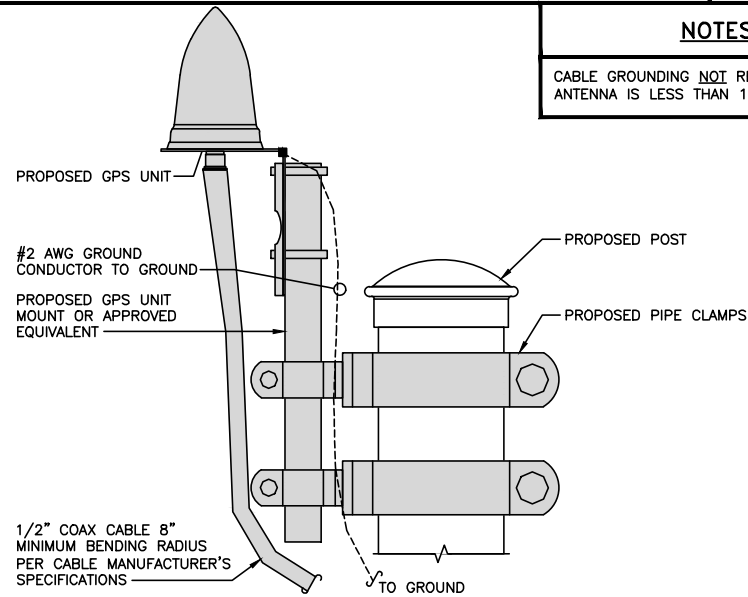

NOTES

CABLE GROUNDING NOT REQUIRED WHEN ANTENNA IS LESS THAN 10' FROM CABINET

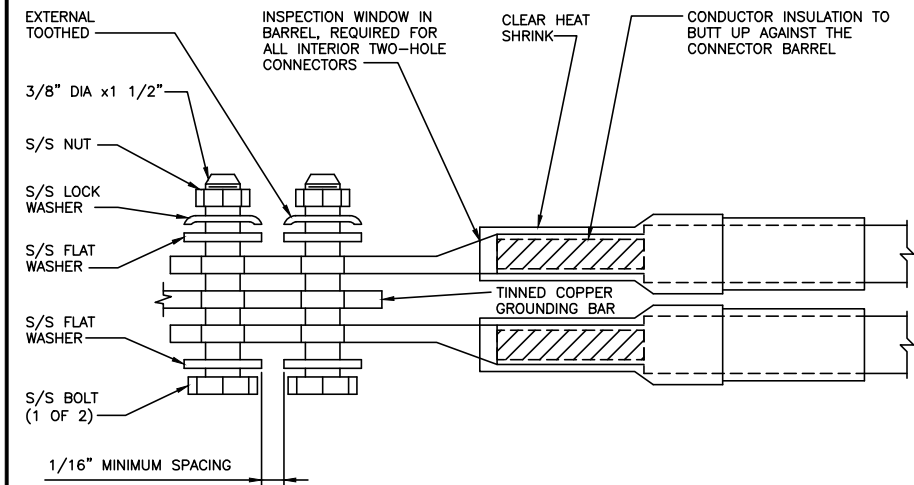
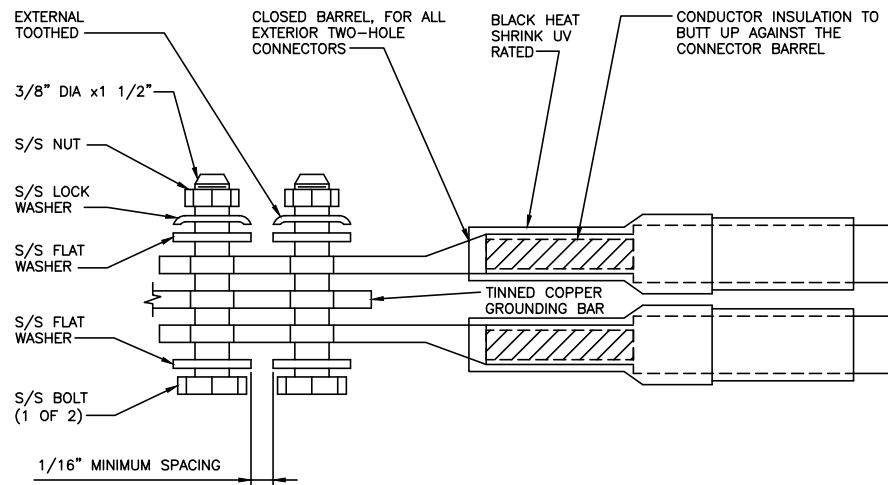

TYPICAL GPS UNIT GROUNDING

NO SCALE 4

TYPICAL EXTERIOR TWO HOLE LUG

NO SCALE 5

TYPICAL INTERIOR TWO HOLE LUG

NO SCALE 6

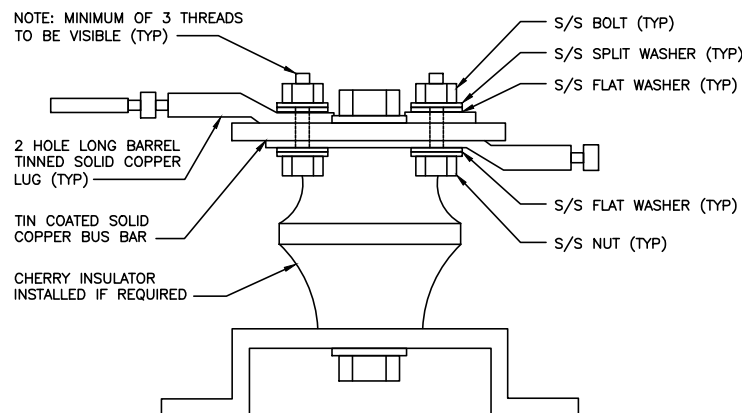

LUG DETAIL

NO SCALE 7

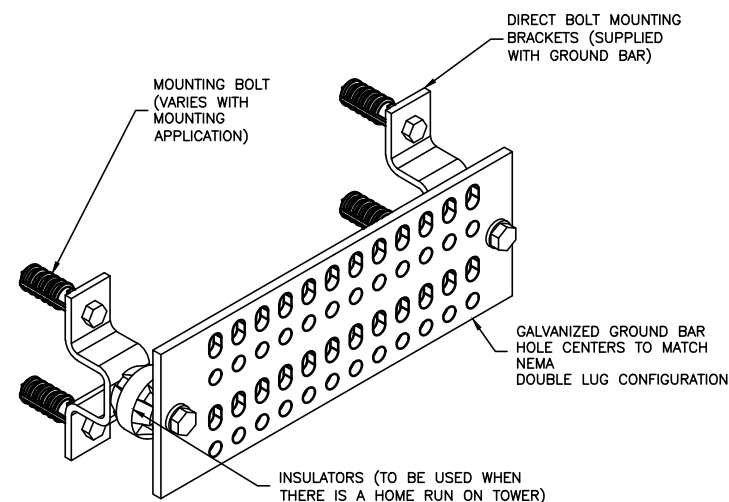

GROUND BAR DETAIL

NO SCALE 8

NOT USED

NO SCALE 9

**dish**  
wireless.

5701 SOUTH SANTA FE DRIVE  
LITTLETON, CO 80120

**NB+C**  
TOTALLY COMMITTED

NB+C ENGINEERING SERVICES, LLC.

100 APOLLO DRIVE  
SUITE 303  
CHELMSFORD, MA 01824  
(978) 856-8308



IT IS A VIOLATION OF LAW FOR ANY PERSON, UNLESS THEY ARE ACTING UNDER THE DIRECTION OF A LICENSED PROFESSIONAL ENGINEER, TO ALTER THIS DOCUMENT.

DRAWN BY: CHECKED BY: APPROVED BY:  
CWE NSB DRG

RFDS REV #: 1

CONSTRUCTION DOCUMENTS

SUBMITTALS		
REV	DATE	DESCRIPTION
0	01/20/22	ISSUED FOR CONSTRUCTION
1	06/27/23	UTILITY ROUTES REVISED

A&E PROJECT NUMBER  
100753

DISH WIRELESS, LLC.  
PROJECT INFORMATION  
BOBOS00343A

1815 MASSACHUSETTS AVE.  
CAMBRIDGE, MA 02140

SHEET TITLE  
GROUNDING DETAILS

SHEET NUMBER

G-3





5701 SOUTH SANTA FE DRIVE  
LITTLETON, CO 80120



NB+C ENGINEERING SERVICES, LLC.

100 APOLLO DRIVE  
SUITE 303  
CHELMSFORD, MA 01824  
(978) 856-8308



IT IS A VIOLATION OF LAW FOR ANY PERSON, UNLESS THEY ARE ACTING UNDER THE DIRECTION OF A LICENSED PROFESSIONAL ENGINEER, TO ALTER THIS DOCUMENT.

DRAWN BY: CWK CHECKED BY: NSB APPROVED BY: DRG

RFDS REV #: 1

CONSTRUCTION DOCUMENTS

SUBMITTALS		
REV	DATE	DESCRIPTION
0	01/20/22	ISSUED FOR CONSTRUCTION
1	06/27/23	UTILITY ROUTES REVISED

A&E PROJECT NUMBER  
100753

DISH WIRELESS, LLC.  
PROJECT INFORMATION  
BOBOS00343A

1815 MASSACHUSETTS AVE.  
CAMBRIDGE, MA 02140

SHEET TITLE  
RF  
CABLE COLOR CODE

SHEET NUMBER  
RF-1

LOW BANDS (N71-N28)  
OPTIONAL - (N29)  
ORANGE

AWS  
(N65+N70+H-BLOCK)  
PURPLE

CBRS TECH  
(3 GHz)  
YELLOW

NEGATIVE SLANT PORT  
ON ANTRRH  
WHITE

ALPHA SECTOR  
RED

BETA SECTOR  
BLUE

GAMMA SECTOR  
GREEN

COLOR IDENTIFIER

NO SCALE

2

NOT USED

NO SCALE

3

NOT USED

NO SCALE

4

RF Cable Color Codes



RF Jumper Color Coding

3/4" tape widths with 3/4" spacing

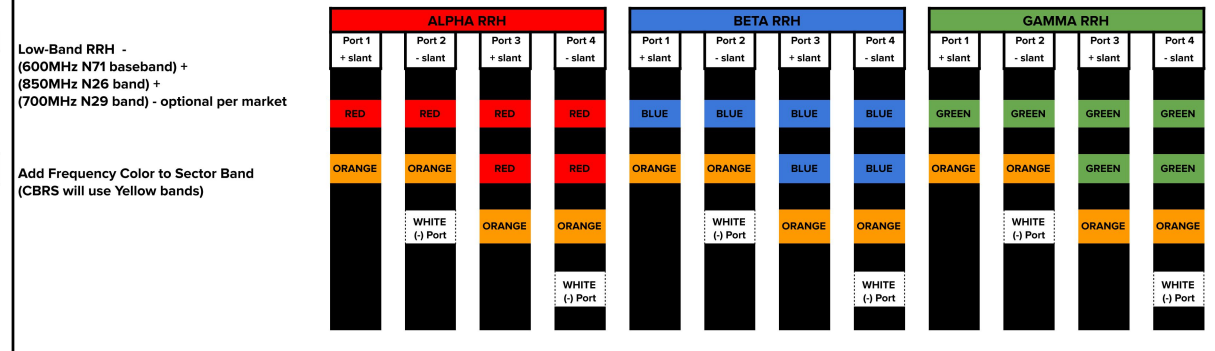

Mid-band RRH - (AWS bands N66+N70)

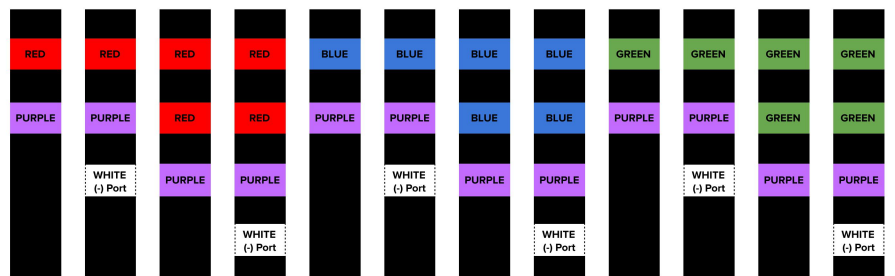

Hybrid/Discreet Cables

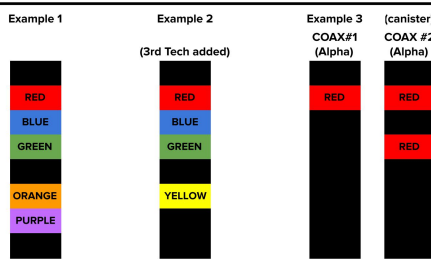

Fiber Jumpers to RRHs

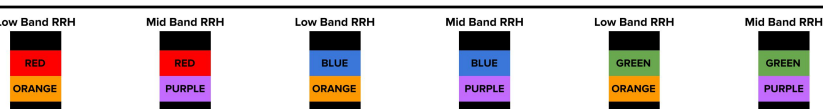

Power Cables to RRHs



RET motors at Antennas

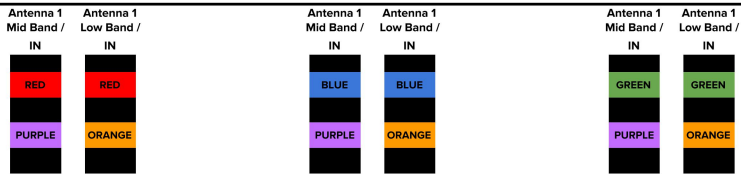

Microwave Radio Links

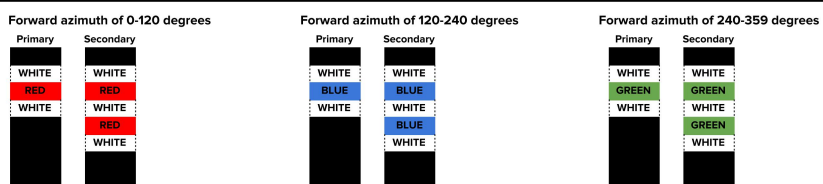

RF CABLE COLOR CODES

NO SCALE

1

NOT USED

NO SCALE

4

EXOTHERMIC CONNECTION  
 MECHANICAL CONNECTION  
 BUSS BAR INSULATOR  
 CHEMICAL ELECTROLYTIC GROUNDING SYSTEM  
 TEST CHEMICAL ELECTROLYTIC GROUNDING SYSTEM  
 EXOTHERMIC WITH INSPECTION SLEEVE  
 GROUNDING BAR  
 GROUND ROD  
 TEST GROUND ROD WITH INSPECTION SLEEVE  
 SINGLE POLE SWITCH  
 DUPLEX RECEPTACLE  
 DUPLEX GFCI RECEPTACLE  
 FLUORESCENT LIGHTING FIXTURE  
 (2) TWO LAMPS 48-T8  
 SMOKE DETECTION (DC)  
 EMERGENCY LIGHTING (DC)  
 SECURITY LIGHT W/PHOTOCELL LITHONIA ALXW  
~~CELANO LUBA 40053~~ K-SR4-120-PE-DBTDX  
 WOOD/WROUGHT IRON FENCE  
 WALL STRUCTURE  
 LEASE AREA  
 PROPERTY LINE (PL)  
 SETBACKS  
 ICE BRIDGE  
 CABLE TRAY  
 WATER LINE  
 UNDERGROUND POWER  
 UNDERGROUND TELCO  
 OVERHEAD POWER  
 OVERHEAD TELCO  
 UNDERGROUND TELCO/POWER  
 ABOVE GROUND POWER  
 ABOVE GROUND TELCO  
 ABOVE GROUND TELCO/POWER  
 WORKPOINT

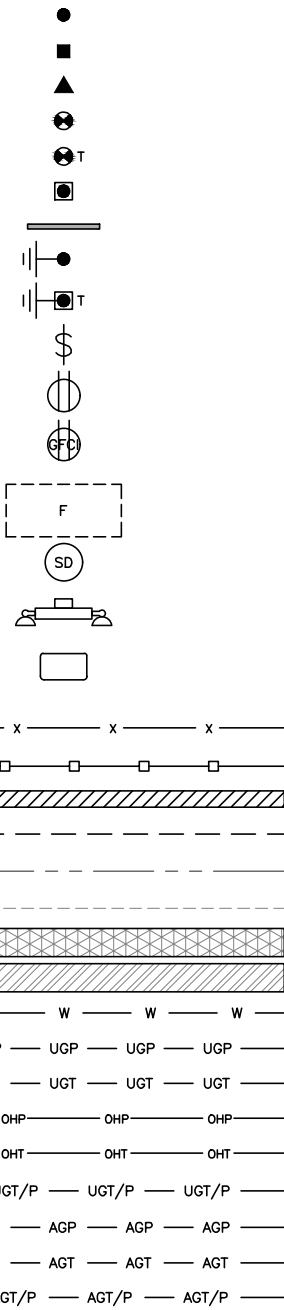

SECTION REFERENCE  
 DETAIL REFERENCE

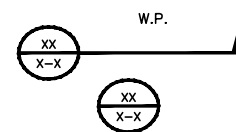

**LEGEND**

AB ANCHOR BOLT  
 ABV ABOVE  
 AC ALTERNATING CURRENT  
 ADDL ADDITIONAL  
 AFF ABOVE FINISHED FLOOR  
 AFG ABOVE FINISHED GRADE  
 AGL ABOVE GROUND LEVEL  
 AIC AMPERAGE INTERRUPTION CAPACITY  
 ALUM ALUMINUM  
 ALT ALTERNATE  
 ANT ANTENNA  
 APPROX APPROXIMATE  
 ARCH ARCHITECTURAL  
 ATS AUTOMATIC TRANSFER SWITCH  
 AWG AMERICAN WIRE GAUGE  
 BATT BATTERY  
 BLDG BUILDING  
 BLK BLOCK  
 BLKG BLOCKING  
 BM BEAM  
 BTC BARE TINNED COPPER CONDUCTOR  
 BOF BOTTOM OF FOOTING  
 CAB CABINET  
 CANT CANTILEVERED  
 CHG CHARGING  
 CLG CEILING  
 CLR CLEAR  
 COL COLUMN  
 COMM COMMON  
 CONC CONCRETE  
 CONSTR CONSTRUCTION  
 DBL DOUBLE  
 DC DIRECT CURRENT  
 DEPT DEPARTMENT  
 DF DOUGLAS FIR  
 DIA DIAMETER  
 DIAG DIAGONAL  
 DIM DIMENSION  
 DWG DRAWING  
 DWL DOWEL  
 EA EACH  
 EC ELECTRICAL CONDUCTOR  
 EL ELEVATION  
 ELEC ELECTRICAL  
 EMT ELECTRICAL METALLIC TUBING  
 ENG ENGINEER  
 EQ EQUAL  
 EXP EXPANSION  
 EXT EXTERIOR  
 EW EACH WAY  
 FAB FABRICATION  
 FF FINISH FLOOR  
 FG FINISH GRADE  
 FIF FACILITY INTERFACE FRAME  
 FIN FINISH(ED)  
 FLR FLOOR  
 FDN FOUNDATION  
 FOC FACE OF CONCRETE  
 FOM FACE OF MASONRY  
 FOS FACE OF STUD  
 FOW FACE OF WALL  
 FS FINISH SURFACE  
 FT FOOT  
 FTG FOOTING  
 GA GAUGE  
 GEN GENERATOR  
 GFCI GROUND FAULT CIRCUIT INTERRUPTER  
 GLB GLUE LAMINATED BEAM  
 GLV GALVANIZED  
 GPS GLOBAL POSITIONING SYSTEM  
 GND GROUND  
 GSM GLOBAL SYSTEM FOR MOBILE  
 HDG HOT DIPPED GALVANIZED  
 HDR HEADER  
 HGR HANGER  
 HVAC HEAT/VENTILATION/AIR CONDITIONING  
 HT HEIGHT  
 IGR INTERIOR GROUND RING

IN INCH  
 INT INTERIOR  
 LB(S) POUND(S)  
 LF LINEAR FEET  
 LTE LONG TERM EVOLUTION  
 MAS MASONRY  
 MAX MAXIMUM  
 MB MACHINE BOLT  
 MECH MECHANICAL  
 MFR MANUFACTURER  
 MGB MASTER GROUND BAR  
 MIN MINIMUM  
 MISC MISCELLANEOUS  
 MTL METAL  
 MTS MANUAL TRANSFER SWITCH  
 MW MICROWAVE  
 NEC NATIONAL ELECTRIC CODE  
 NM NEWTON METERS  
 NO. NUMBER  
 # NUMBER  
 NTS NOT TO SCALE  
 OC ON-CENTER  
 OSHA OCCUPATIONAL SAFETY AND HEALTH ADMINISTRATION  
 OPNG OPENING  
 P/C PRECAST CONCRETE  
 PCS PERSONAL COMMUNICATION SERVICES  
 PCU PRIMARY CONTROL UNIT  
 PRC PRIMARY RADIO CABINET  
 PP POLARIZING PRESERVING  
 PSF POUNDS PER SQUARE FOOT  
 PSI POUNDS PER SQUARE INCH  
 PT PRESSURE TREATED  
 PWR POWER CABINET  
 QTY QUANTITY  
 RAD RADIUS  
 RECT RECTIFIER  
 REF REFERENCE  
 REINF REINFORCEMENT  
 REQ'D REQUIRED  
 RET REMOTE ELECTRIC TILT  
 RF RADIO FREQUENCY  
 RMC RIGID METALLIC CONDUIT  
 RRH REMOTE RADIO HEAD  
 RRU REMOTE RADIO UNIT  
 RWY RACEWAY  
 SCH SCHEDULE  
 SHT SHEET  
 SIAD SMART INTEGRATED ACCESS DEVICE  
 SIM SIMILAR  
 SPEC SPECIFICATION  
 SQ SQUARE  
 SS STAINLESS STEEL  
 STD STANDARD  
 STL STEEL  
 TEMP TEMPORARY  
 THK THICKNESS  
 TMA TOWER MOUNTED AMPLIFIER  
 TN TOE NAIL  
 TOA TOP OF ANTENNA  
 TOC TOP OF CURB  
 TOF TOP OF FOUNDATION  
 TOP TOP OF PLATE (PARAPET)  
 TOS TOP OF STEEL  
 TOW TOP OF WALL  
 TVSS TRANSIENT VOLTAGE SURGE SUPPRESSION  
 TYP TYPICAL  
 UG UNDERGROUND  
 UL UNDERWRITERS LABORATORY  
 UNO UNLESS NOTED OTHERWISE  
 UMTS UNIVERSAL MOBILE TELECOMMUNICATIONS SYSTEM  
 UPS UNINTERRUPTIBLE POWER SYSTEM (DC POWER PLANT)  
 VIF VERIFIED IN FIELD  
 W WIDE  
 W/ WITH  
 WD WOOD  
 WP WEATHERPROOF  
 WT WEIGHT

**ABBREVIATIONS**



5701 SOUTH SANTA FE DRIVE  
 LITTLETON, CO 80120



**NB+C ENGINEERING SERVICES, LLC.**

100 APOLLO DRIVE  
 SUITE 303  
 CHELMSFORD, MA 01824  
 (978) 856-8308



IT IS A VIOLATION OF LAW FOR ANY PERSON,  
 UNLESS THEY ARE ACTING UNDER THE DIRECTION  
 OF A LICENSED PROFESSIONAL ENGINEER,  
 TO ALTER THIS DOCUMENT.

DRAWN BY:	CHECKED BY:	APPROVED BY:
CWE	NSB	DRG

RFDS REV #: 1

**CONSTRUCTION DOCUMENTS**

SUBMITTALS		
REV	DATE	DESCRIPTION
0	01/20/22	ISSUED FOR CONSTRUCTION
1	06/27/23	UTILITY ROUTES REVISED

A&E PROJECT NUMBER  
**100753**

DISH WIRELESS, LLC.  
 PROJECT INFORMATION  
**BOBOS00343A**

1815 MASSACHUSETTS AVE.  
 CAMBRIDGE, MA 02140

SHEET TITLE  
**LEGEND AND ABBREVIATIONS**

SHEET NUMBER  
**GN-1**

**SITE ACTIVITY REQUIREMENTS:**

1. NOTICE TO PROCEED – NO WORK SHALL COMMENCE PRIOR TO CONTRACTOR RECEIVING A WRITTEN NOTICE TO PROCEED (NTP) AND THE ISSUANCE OF A PURCHASE ORDER. PRIOR TO ACCESSING/ENTERING THE SITE YOU MUST CONTACT THE DISH WIRELESS, LLC. AND TOWER OWNER NOC & THE DISH WIRELESS, LLC. AND TOWER OWNER CONSTRUCTION MANAGER.
2. "LOOK UP" – DISH WIRELESS, LLC. AND TOWER OWNER SAFETY CLIMB REQUIREMENT:  
THE INTEGRITY OF THE SAFETY CLIMB AND ALL COMPONENTS OF THE CLIMBING FACILITY SHALL BE CONSIDERED DURING ALL STAGES OF DESIGN, INSTALLATION, AND INSPECTION. TOWER MODIFICATION, MOUNT REINFORCEMENTS, AND/OR EQUIPMENT INSTALLATIONS SHALL NOT COMPROMISE THE INTEGRITY OR FUNCTIONAL USE OF THE SAFETY CLIMB OR ANY COMPONENTS OF THE CLIMBING FACILITY ON THE STRUCTURE. THIS SHALL INCLUDE, BUT NOT BE LIMITED TO: PINCHING OF THE WIRE ROPE, BENDING OF THE WIRE ROPE FROM ITS SUPPORTS, DIRECT CONTACT OR CLOSE PROXIMITY TO THE WIRE ROPE WHICH MAY CAUSE FRICTIONAL WEAR, IMPACT TO THE ANCHORAGE POINTS IN ANY WAY, OR TO IMPEDE/BLOCK ITS INTENDED USE. ANY COMPROMISED SAFETY CLIMB, INCLUDING EXISTING CONDITIONS MUST BE TAGGED OUT AND REPORTED TO YOUR DISH WIRELESS, LLC. AND DISH WIRELESS, LLC. AND TOWER OWNER POC OR CALL THE NOC TO GENERATE A SAFETY CLIMB MAINTENANCE AND CONTRACTOR NOTICE TICKET.
3. PRIOR TO THE START OF CONSTRUCTION, ALL REQUIRED JURISDICTIONAL PERMITS SHALL BE OBTAINED. THIS INCLUDES, BUT IS NOT LIMITED TO, BUILDING, ELECTRICAL, MECHANICAL, FIRE, FLOOD ZONE, ENVIRONMENTAL, AND ZONING. AFTER ONSITE ACTIVITIES AND CONSTRUCTION ARE COMPLETED, ALL REQUIRED PERMITS SHALL BE SATISFIED AND CLOSED OUT ACCORDING TO LOCAL JURISDICTIONAL REQUIREMENTS.
4. ALL CONSTRUCTION MEANS AND METHODS; INCLUDING BUT NOT LIMITED TO, ERECTION PLANS, RIGGING PLANS, CLIMBING PLANS, AND RESCUE PLANS SHALL BE THE RESPONSIBILITY OF THE GENERAL CONTRACTOR RESPONSIBLE FOR THE EXECUTION OF THE WORK CONTAINED HEREIN, AND SHALL MEET ANSI/ASSE A10.48 (LATEST EDITION); FEDERAL, STATE, AND LOCAL REGULATIONS; AND ANY APPLICABLE INDUSTRY CONSENSUS STANDARDS RELATED TO THE CONSTRUCTION ACTIVITIES BEING PERFORMED. ALL RIGGING PLANS SHALL ADHERE TO ANSI/ASSE A10.48 (LATEST EDITION) AND DISH WIRELESS, LLC. AND TOWER OWNER STANDARDS, INCLUDING THE REQUIRED INVOLVEMENT OF A QUALIFIED ENGINEER FOR CLASS IV CONSTRUCTION, TO CERTIFY THE SUPPORTING STRUCTURE(S) IN ACCORDANCE WITH ANSI/TIA-322 (LATEST EDITION).
5. ALL SITE WORK TO COMPLY WITH DISH WIRELESS, LLC. AND TOWER OWNER INSTALLATION STANDARDS FOR CONSTRUCTION ACTIVITIES ON DISH WIRELESS, LLC. AND TOWER OWNER TOWER SITE AND LATEST VERSION OF ANSI/TIA-1019-A-2012 "STANDARD FOR INSTALLATION, ALTERATION, AND MAINTENANCE OF ANTENNA SUPPORTING STRUCTURES AND ANTENNAS."
6. IF THE SPECIFIED EQUIPMENT CAN NOT BE INSTALLED AS SHOWN ON THESE DRAWINGS, THE CONTRACTOR SHALL PROPOSE AN ALTERNATIVE INSTALLATION FOR APPROVAL BY DISH WIRELESS, LLC. AND TOWER OWNER PRIOR TO PROCEEDING WITH ANY SUCH CHANGE OF INSTALLATION.
7. ALL MATERIALS FURNISHED AND INSTALLED SHALL BE IN STRICT ACCORDANCE WITH ALL APPLICABLE CODES, REGULATIONS AND ORDINANCES. CONTRACTOR SHALL ISSUE ALL APPROPRIATE NOTICES AND COMPLY WITH ALL LAWS, ORDINANCES, RULES, REGULATIONS AND LAWFUL ORDERS OF ANY PUBLIC AUTHORITY REGARDING THE PERFORMANCE OF THE WORK. ALL WORK CARRIED OUT SHALL COMPLY WITH ALL APPLICABLE MUNICIPAL AND UTILITY COMPANY SPECIFICATIONS AND LOCAL JURISDICTIONAL CODES, ORDINANCES AND APPLICABLE REGULATIONS.
8. THE CONTRACTOR SHALL INSTALL ALL EQUIPMENT AND MATERIALS IN ACCORDANCE WITH MANUFACTURER'S RECOMMENDATIONS UNLESS SPECIFICALLY STATED OTHERWISE.
9. THE CONTRACTOR SHALL CONTACT UTILITY LOCATING SERVICES INCLUDING PRIVATE LOCATES SERVICES PRIOR TO THE START OF CONSTRUCTION.
10. ALL EXISTING ACTIVE SEWER, WATER, GAS, ELECTRIC AND OTHER UTILITIES WHERE ENCOUNTERED IN THE WORK, SHALL BE PROTECTED AT ALL TIMES AND WHERE REQUIRED FOR THE PROPER EXECUTION OF THE WORK, SHALL BE RELOCATED AS DIRECTED BY CONTRACTOR. EXTREME CAUTION SHOULD BE USED BY THE CONTRACTOR WHEN EXCAVATING OR DRILLING PIERS AROUND OR NEAR UTILITIES. CONTRACTOR SHALL PROVIDE SAFETY TRAINING FOR THE WORKING CREW. THIS WILL INCLUDE BUT NOT BE LIMITED TO A) FALL PROTECTION B) CONFINED SPACE C) ELECTRICAL SAFETY D) TRENCHING AND EXCAVATION E) CONSTRUCTION SAFETY PROCEDURES.
11. ALL SITE WORK SHALL BE AS INDICATED ON THE STAMPED CONSTRUCTION DRAWINGS AND DISH PROJECT SPECIFICATIONS, LATEST APPROVED REVISION.
12. CONTRACTOR SHALL KEEP THE SITE FREE FROM ACCUMULATING WASTE MATERIAL, DEBRIS, AND TRASH AT THE COMPLETION OF THE WORK. IF NECESSARY, RUBBISH, STUMPS, DEBRIS, STICKS, STONES AND OTHER REFUSE SHALL BE REMOVED FROM THE SITE AND DISPOSED OF LEGALLY.
13. ALL EXISTING INACTIVE SEWER, WATER, GAS, ELECTRIC AND OTHER UTILITIES, WHICH INTERFERE WITH THE EXECUTION OF THE WORK, SHALL BE REMOVED AND/OR CAPPED, PLUGGED OR OTHERWISE DISCONTINUED AT POINTS WHICH WILL NOT INTERFERE WITH THE EXECUTION OF THE WORK, SUBJECT TO THE APPROVAL OF DISH WIRELESS, LLC. AND TOWER OWNER, AND/OR LOCAL UTILITIES.
14. THE CONTRACTOR SHALL PROVIDE SITE SIGNAGE IN ACCORDANCE WITH THE TECHNICAL SPECIFICATION FOR SITE SIGNAGE REQUIRED BY LOCAL JURISDICTION AND SIGNAGE REQUIRED ON INDIVIDUAL PIECES OF EQUIPMENT, ROOMS, AND SHELTERS.
15. THE SITE SHALL BE GRADED TO CAUSE SURFACE WATER TO FLOW AWAY FROM THE CARRIER'S EQUIPMENT AND TOWER AREAS.
16. THE SUB GRADE SHALL BE COMPACTED AND BROUGHT TO A SMOOTH UNIFORM GRADE PRIOR TO FINISHED SURFACE APPLICATION.
17. THE AREAS OF THE OWNERS PROPERTY DISTURBED BY THE WORK AND NOT COVERED BY THE TOWER, EQUIPMENT OR DRIVEWAY, SHALL BE GRADED TO A UNIFORM SLOPE, AND STABILIZED TO PREVENT EROSION AS SPECIFIED ON THE CONSTRUCTION DRAWINGS AND/OR PROJECT SPECIFICATIONS.
18. CONTRACTOR SHALL MINIMIZE DISTURBANCE TO EXISTING SITE DURING CONSTRUCTION. EROSION CONTROL MEASURES, IF REQUIRED DURING CONSTRUCTION, SHALL BE IN CONFORMANCE WITH THE LOCAL GUIDELINES FOR EROSION AND SEDIMENT CONTROL.
19. THE CONTRACTOR SHALL PROTECT EXISTING IMPROVEMENTS, PAVEMENTS, CURBS, LANDSCAPING AND STRUCTURES. ANY DAMAGED PART SHALL BE REPAIRED AT CONTRACTOR'S EXPENSE TO THE SATISFACTION OF OWNER.
20. CONTRACTOR SHALL LEGALLY AND PROPERLY DISPOSE OF ALL SCRAP MATERIALS SUCH AS COAXIAL CABLES AND OTHER ITEMS REMOVED FROM THE EXISTING FACILITY. ANTENNAS AND RADIOS REMOVED SHALL BE RETURNED TO THE OWNER'S DESIGNATED LOCATION.
21. CONTRACTOR SHALL LEAVE PREMISES IN CLEAN CONDITION. TRASH AND DEBRIS SHOULD BE REMOVED FROM SITE ON A DAILY BASIS.
22. NO FILL OR EMBANKMENT MATERIAL SHALL BE PLACED ON FROZEN GROUND. FROZEN MATERIALS, SNOW OR ICE SHALL NOT BE PLACED IN ANY FILL OR EMBANKMENT.

**GENERAL NOTES:**

1. FOR THE PURPOSE OF CONSTRUCTION DRAWING, THE FOLLOWING DEFINITIONS SHALL APPLY:  
CONTRACTOR: GENERAL CONTRACTOR RESPONSIBLE FOR CONSTRUCTION  
CARRIER: DISH WIRELESS, LLC.  
TOWER OWNER: TOWER OWNER
2. THESE DRAWINGS HAVE BEEN PREPARED USING STANDARDS OF PROFESSIONAL CARE AND COMPLETENESS NORMALLY EXERCISED UNDER SIMILAR CIRCUMSTANCES BY REPUTABLE ENGINEERS IN THIS OR SIMILAR LOCALITIES. IT IS ASSUMED THAT THE WORK DEPICTED WILL BE PERFORMED BY AN EXPERIENCED CONTRACTOR AND/OR WORKPEOPLE WHO HAVE A WORKING KNOWLEDGE OF THE APPLICABLE CODE STANDARDS AND REQUIREMENTS AND OF INDUSTRY ACCEPTED STANDARD GOOD PRACTICE. AS NOT EVERY CONDITION OR ELEMENT IS (OR CAN BE) EXPLICITLY SHOWN ON THESE DRAWINGS, THE CONTRACTOR SHALL USE INDUSTRY ACCEPTED STANDARD GOOD PRACTICE FOR MISCELLANEOUS WORK NOT EXPLICITLY SHOWN.
3. THESE DRAWINGS REPRESENT THE FINISHED STRUCTURE. THEY DO NOT INDICATE THE MEANS OR METHODS OF CONSTRUCTION. THE CONTRACTOR SHALL BE SOLELY RESPONSIBLE FOR THE CONSTRUCTION MEANS, METHODS, TECHNIQUES, SEQUENCES, AND PROCEDURES. THE CONTRACTOR SHALL PROVIDE ALL MEASURES NECESSARY FOR PROTECTION OF LIFE AND PROPERTY DURING CONSTRUCTION. SUCH MEASURES SHALL INCLUDE, BUT NOT BE LIMITED TO, BRACING, FORMWORK, SHORING, ETC. SITE VISITS BY THE ENGINEER OR HIS REPRESENTATIVE WILL NOT INCLUDE INSPECTION OF THESE ITEMS AND IS FOR STRUCTURAL OBSERVATION OF THE FINISHED STRUCTURE ONLY.
4. NOTES AND DETAILS IN THE CONSTRUCTION DRAWINGS SHALL TAKE PRECEDENCE OVER GENERAL NOTES AND TYPICAL DETAILS. WHERE NO DETAILS ARE SHOWN, CONSTRUCTION SHALL CONFORM TO SIMILAR WORK ON THE PROJECT, AND/OR AS PROVIDED FOR IN THE CONTRACT DOCUMENTS. WHERE DISCREPANCIES OCCUR BETWEEN PLANS, DETAILS, GENERAL NOTES, AND SPECIFICATIONS, THE GREATER, MORE STRICT REQUIREMENTS, SHALL GOVERN. IF FURTHER CLARIFICATION IS REQUIRED CONTACT THE ENGINEER OF RECORD.
5. SUBSTANTIAL EFFORT HAS BEEN MADE TO PROVIDE ACCURATE DIMENSIONS AND MEASUREMENTS ON THE DRAWINGS TO ASSIST IN THE FABRICATION AND/OR PLACEMENT OF CONSTRUCTION ELEMENTS BUT IT IS THE SOLE RESPONSIBILITY OF THE CONTRACTOR TO FIELD VERIFY THE DIMENSIONS, MEASUREMENTS, AND/OR CLEARANCES SHOWN IN THE CONSTRUCTION DRAWINGS PRIOR TO FABRICATION OR CUTTING OF ANY NEW OR EXISTING CONSTRUCTION ELEMENTS. IF IT IS DETERMINED THAT THERE ARE DISCREPANCIES AND/OR CONFLICTS WITH THE CONSTRUCTION DRAWINGS THE ENGINEER OF RECORD IS TO BE NOTIFIED AS SOON AS POSSIBLE.
6. PRIOR TO THE SUBMISSION OF BIDS, THE BIDDING CONTRACTOR SHALL VISIT THE CELL SITE TO FAMILIARIZE WITH THE EXISTING CONDITIONS AND TO CONFIRM THAT THE WORK CAN BE ACCOMPLISHED AS SHOWN ON THE CONSTRUCTION DRAWINGS. ANY DISCREPANCY FOUND SHALL BE BROUGHT TO THE ATTENTION OF CARRIER POC AND TOWER OWNER.
7. ALL MATERIALS FURNISHED AND INSTALLED SHALL BE IN STRICT ACCORDANCE WITH ALL APPLICABLE CODES, REGULATIONS AND ORDINANCES. CONTRACTOR SHALL ISSUE ALL APPROPRIATE NOTICES AND COMPLY WITH ALL LAWS, ORDINANCES, RULES, REGULATIONS AND LAWFUL ORDERS OF ANY PUBLIC AUTHORITY REGARDING THE PERFORMANCE OF THE WORK. ALL WORK CARRIED OUT SHALL COMPLY WITH ALL APPLICABLE MUNICIPAL AND UTILITY COMPANY SPECIFICATIONS AND LOCAL JURISDICTIONAL CODES, ORDINANCES AND APPLICABLE REGULATIONS.
8. UNLESS NOTED OTHERWISE, THE WORK SHALL INCLUDE FURNISHING MATERIALS, EQUIPMENT, APPURTENANCES AND LABOR NECESSARY TO COMPLETE ALL INSTALLATIONS AS INDICATED ON THE DRAWINGS.
9. THE CONTRACTOR SHALL INSTALL ALL EQUIPMENT AND MATERIALS IN ACCORDANCE WITH MANUFACTURER'S RECOMMENDATIONS UNLESS SPECIFICALLY STATED OTHERWISE.
10. IF THE SPECIFIED EQUIPMENT CAN NOT BE INSTALLED AS SHOWN ON THESE DRAWINGS, THE CONTRACTOR SHALL PROPOSE AN ALTERNATIVE INSTALLATION FOR APPROVAL BY THE CARRIER AND TOWER OWNER PRIOR TO PROCEEDING WITH ANY SUCH CHANGE OF INSTALLATION.
11. CONTRACTOR IS TO PERFORM A SITE INVESTIGATION, BEFORE SUBMITTING BIDS, TO DETERMINE THE BEST ROUTING OF ALL CONDUITS FOR POWER, AND TELCO AND FOR GROUNDING CABLES AS SHOWN IN THE POWER, TELCO, AND GROUNDING PLAN DRAWINGS.
12. THE CONTRACTOR SHALL PROTECT EXISTING IMPROVEMENTS, PAVEMENTS, CURBS, LANDSCAPING AND STRUCTURES. ANY DAMAGED PART SHALL BE REPAIRED AT CONTRACTOR'S EXPENSE TO THE SATISFACTION OF DISH WIRELESS, LLC. AND TOWER OWNER
13. CONTRACTOR SHALL LEGALLY AND PROPERLY DISPOSE OF ALL SCRAP MATERIALS SUCH AS COAXIAL CABLES AND OTHER ITEMS REMOVED FROM THE EXISTING FACILITY. ANTENNAS REMOVED SHALL BE RETURNED TO THE OWNER'S DESIGNATED LOCATION.
14. CONTRACTOR SHALL LEAVE PREMISES IN CLEAN CONDITION. TRASH AND DEBRIS SHOULD BE REMOVED FROM SITE ON A DAILY BASIS.



5701 SOUTH SANTA FE DRIVE  
LITTLETON, CO 80120



**NB+C ENGINEERING SERVICES, LLC.**

100 APOLLO DRIVE  
SUITE 303  
CHELMSFORD, MA 01824  
(978) 856-8308



IT IS A VIOLATION OF LAW FOR ANY PERSON, UNLESS THEY ARE ACTING UNDER THE DIRECTION OF A LICENSED PROFESSIONAL ENGINEER, TO ALTER THIS DOCUMENT.

DRAWN BY:	CHECKED BY:	APPROVED BY:
CWE	NSB	DRG

RFDS REV #: 1

**CONSTRUCTION DOCUMENTS**

SUBMITTALS		
REV	DATE	DESCRIPTION
0	01/20/22	ISSUED FOR CONSTRUCTION
1	06/27/23	UTILITY ROUTES REVISED

A&E PROJECT NUMBER  
**100753**

DISH WIRELESS, LLC.  
PROJECT INFORMATION  
**BOBOS00343A**

1815 MASSACHUSETTS AVE.  
CAMBRIDGE, MA 02140

SHEET TITLE  
**GENERAL NOTES**

SHEET NUMBER  
**GN-2**



**CONCRETE, FOUNDATIONS, AND REINFORCING STEEL:**

1. ALL CONCRETE WORK SHALL BE IN ACCORDANCE WITH THE ACI 301, ACI 318, ACI 336, ASTM A184, ASTM A185 AND THE DESIGN AND CONSTRUCTION SPECIFICATION FOR CAST-IN-PLACE CONCRETE.
2. UNLESS NOTED OTHERWISE, SOIL BEARING PRESSURE USED FOR DESIGN OF SLABS AND FOUNDATIONS IS ASSUMED TO BE 1000 psf.
3. ALL CONCRETE SHALL HAVE A MINIMUM COMPRESSIVE STRENGTH (f'c) OF 3000 psi AT 28 DAYS, UNLESS NOTED OTHERWISE. NO MORE THAN 90 MINUTES SHALL ELAPSE FROM BATCH TIME TO TIME OF PLACEMENT UNLESS APPROVED BY THE ENGINEER OF RECORD. TEMPERATURE OF CONCRETE SHALL NOT EXCEED 90°f AT TIME OF PLACEMENT.
4. CONCRETE EXPOSED TO FREEZE-THAW CYCLES SHALL CONTAIN AIR ENTRAINING ADMIXTURES. AMOUNT OF AIR ENTRAINMENT TO BE BASED ON SIZE OF AGGREGATE AND F3 CLASS EXPOSURE (VERY SEVERE). CEMENT USED TO BE TYPE II PORTLAND CEMENT WITH A MAXIMUM WATER-TO-CEMENT RATIO (W/C) OF 0.45.
5. ALL STEEL REINFORCING SHALL CONFORM TO ASTM A615. ALL WELDED WIRE FABRIC (WWF) SHALL CONFORM TO ASTM A185. ALL SPLICES SHALL BE CLASS "B" TENSION SPLICES, UNLESS NOTED OTHERWISE. ALL HOOKS SHALL BE STANDARD 90 DEGREE HOOKS, UNLESS NOTED OTHERWISE. YIELD STRENGTH (Fy) OF STANDARD DEFORMED BARS ARE AS FOLLOWS:  
 #4 BARS AND SMALLER 40 ksi  
 #5 BARS AND LARGER 60 ksi
6. THE FOLLOWING MINIMUM CONCRETE COVER SHALL BE PROVIDED FOR REINFORCING STEEL UNLESS SHOWN OTHERWISE ON DRAWINGS:
  - CONCRETE CAST AGAINST AND PERMANENTLY EXPOSED TO EARTH 3"
  - CONCRETE EXPOSED TO EARTH OR WEATHER:
    - #6 BARS AND LARGER 2"
    - #5 BARS AND SMALLER 1-1/2"
  - CONCRETE NOT EXPOSED TO EARTH OR WEATHER:
    - SLAB AND WALLS 3/4"
    - BEAMS AND COLUMNS 1-1/2"
7. A TOOLED EDGE OR A 3/4" CHAMFER SHALL BE PROVIDED AT ALL EXPOSED EDGES OF CONCRETE, UNLESS NOTED OTHERWISE, IN ACCORDANCE WITH ACI 301 SECTION 4.2.4.

**ELECTRICAL INSTALLATION NOTES:**

1. ALL ELECTRICAL WORK SHALL BE PERFORMED IN ACCORDANCE WITH THE PROJECT SPECIFICATIONS, NEC AND ALL APPLICABLE FEDERAL, STATE, AND LOCAL CODES/ORDINANCES.
2. CONDUIT ROUTINGS ARE SCHEMATIC. CONTRACTOR SHALL INSTALL CONDUITS SO THAT ACCESS TO EQUIPMENT IS NOT BLOCKED AND TRIP HAZARDS ARE ELIMINATED.
3. WIRING, RACEWAY AND SUPPORT METHODS AND MATERIALS SHALL COMPLY WITH THE REQUIREMENTS OF THE NEC.
4. ALL CIRCUITS SHALL BE SEGREGATED AND MAINTAIN MINIMUM CABLE SEPARATION AS REQUIRED BY THE NEC.
- 4.1. ALL EQUIPMENT SHALL BEAR THE UNDERWRITERS LABORATORIES LABEL OF APPROVAL, AND SHALL CONFORM TO REQUIREMENT OF THE NATIONAL ELECTRICAL CODE.
- 4.2. ALL OVERCURRENT DEVICES SHALL HAVE AN INTERRUPTING CURRENT RATING THAT SHALL BE GREATER THAN THE SHORT CIRCUIT CURRENT TO WHICH THEY ARE SUBJECTED, 22,000 AIC MINIMUM. VERIFY AVAILABLE SHORT CIRCUIT CURRENT DOES NOT EXCEED THE RATING OF ELECTRICAL EQUIPMENT IN ACCORDANCE WITH ARTICLE 110.24 NEC OR THE MOST CURRENT ADOPTED CODE PRE THE GOVERNING JURISDICTION.
5. EACH END OF EVERY POWER PHASE CONDUCTOR, GROUNDING CONDUCTOR, AND TELCO CONDUCTOR OR CABLE SHALL BE LABELED WITH COLOR-CODED INSULATION OR ELECTRICAL TAPE (3M BRAND, 1/2" PLASTIC ELECTRICAL TAPE WITH UV PROTECTION, OR EQUAL). THE IDENTIFICATION METHOD SHALL CONFORM WITH NEC AND OSHA.
6. ALL ELECTRICAL COMPONENTS SHALL BE CLEARLY LABELED WITH LAMICOID TAGS SHOWING THEIR RATED VOLTAGE, PHASE CONFIGURATION, WIRE CONFIGURATION, POWER OR AMPACITY RATING AND BRANCH CIRCUIT ID NUMBERS (i.e. PANEL BOARD AND CIRCUIT ID'S).
7. PANEL BOARDS (ID NUMBERS) SHALL BE CLEARLY LABELED WITH PLASTIC LABELS.
8. TIE WRAPS ARE NOT ALLOWED.
9. ALL POWER AND EQUIPMENT GROUND WIRING IN TUBING OR CONDUIT SHALL BE SINGLE COPPER CONDUCTOR (#14 OR LARGER) WITH TYPE THHW, THWN, THWN-2, XHHW, XHHW-2, THW, THW-2, RHW, OR RHW-2 INSULATION UNLESS OTHERWISE SPECIFIED.
10. SUPPLEMENTAL EQUIPMENT GROUND WIRING LOCATED INDOORS SHALL BE SINGLE COPPER CONDUCTOR (#6 OR LARGER) WITH TYPE THHW, THWN, THWN-2, XHHW, XHHW-2, THW, THW-2, RHW, OR RHW-2 INSULATION UNLESS OTHERWISE SPECIFIED.
11. POWER AND CONTROL WIRING IN FLEXIBLE CORD SHALL BE MULTI-CONDUCTOR, TYPE SOOW CORD (#14 OR LARGER) UNLESS OTHERWISE SPECIFIED.
12. POWER AND CONTROL WIRING FOR USE IN CABLE TRAY SHALL BE MULTI-CONDUCTOR, TYPE TC CABLE (#14 OR LARGER), WITH TYPE THHW, THWN, THWN-2, XHHW, XHHW-2, THW, THW-2, RHW, OR RHW-2 INSULATION UNLESS OTHERWISE SPECIFIED.
13. ALL POWER AND GROUNDING CONNECTIONS SHALL BE CRIMP-STYLE, COMPRESSION WIRE LUGS AND WIRE NUTS BY THOMAS AND BETTS (OR EQUAL). LUGS AND WIRE NUTS SHALL BE RATED FOR OPERATION NOT LESS THAN 75° C (90° C IF AVAILABLE).
14. RACEWAY AND CABLE TRAY SHALL BE LISTED OR LABELED FOR ELECTRICAL USE IN ACCORDANCE WITH NEMA, UL, ANSI/IEEE AND NEC.
15. ELECTRICAL METALLIC TUBING (EMT), INTERMEDIATE METAL CONDUIT (IMC), OR RIGID METAL CONDUIT (RMC) SHALL BE USED FOR EXPOSED INDOOR LOCATIONS.

16. ELECTRICAL METALLIC TUBING (EMT) OR METAL-CLAD CABLE (MC) SHALL BE USED FOR CONCEALED INDOOR LOCATIONS.
17. SCHEDULE 40 PVC UNDERGROUND ON STRAIGHTS AND SCHEDULE 80 PVC FOR ALL ELBOWS/90s AND ALL APPROVED ABOVE GRADE PVC CONDUIT.
18. LIQUID-TIGHT FLEXIBLE METALLIC CONDUIT (LIQUID-TITE FLEX) SHALL BE USED INDOORS AND OUTDOORS, WHERE VIBRATION OCCURS OR FLEXIBILITY IS NEEDED.
19. CONDUIT AND TUBING FITTINGS SHALL BE THREADED OR COMPRESSION-TYPE AND APPROVED FOR THE LOCATION USED. SET SCREW FITTINGS ARE NOT ACCEPTABLE.
20. CABINETS, BOXES AND WIRE WAYS SHALL BE LABELED FOR ELECTRICAL USE IN ACCORDANCE WITH NEMA, UL, ANSI/IEEE AND THE NEC.
21. WIREWAYS SHALL BE METAL WITH AN ENAMEL FINISH AND INCLUDE A HINGED COVER, DESIGNED TO SWING OPEN DOWNWARDS (WIREMOLD SPECMATE WIREWAY).
22. SLOTTED WIRING DUCT SHALL BE PVC AND INCLUDE COVER (PANDUIT TYPE E OR EQUAL).
23. CONDUITS SHALL BE FASTENED SECURELY IN PLACE WITH APPROVED NON-PERFORATED STRAPS AND HANGERS. EXPLOSIVE DEVICES (i.e. POWDER-ACTUATED) FOR ATTACHING HANGERS TO STRUCTURE WILL NOT BE PERMITTED. CLOSELY FOLLOW THE LINES OF THE STRUCTURE, MAINTAIN CLOSE PROXIMITY TO THE STRUCTURE AND KEEP CONDUITS IN TIGHT ENVELOPES. CHANGES IN DIRECTION TO ROUTE AROUND OBSTACLES SHALL BE MADE WITH CONDUIT OUTLET BODIES. CONDUIT SHALL BE INSTALLED IN A NEAT AND WORKMANLIKE MANNER. PARALLEL AND PERPENDICULAR TO STRUCTURE WALL AND CEILING LINES. ALL CONDUIT SHALL BE FISHED TO CLEAR OBSTRUCTIONS. ENDS OF CONDUITS SHALL BE TEMPORARILY CAPPED FLUSH TO FINISH GRADE TO PREVENT CONCRETE, PLASTER OR DIRT FROM ENTERING. CONDUITS SHALL BE RIGIDLY CLAMPED TO BOXES BY GALVANIZED MALLEABLE IRON BUSHING ON INSIDE AND GALVANIZED MALLEABLE IRON LOCKNUT ON OUTSIDE AND INSIDE.
24. EQUIPMENT CABINETS, TERMINAL BOXES, JUNCTION BOXES AND PULL BOXES SHALL BE GALVANIZED OR EPOXY-COATED SHEET STEEL. SHALL MEET OR EXCEED UL 50 AND BE RATED NEMA 1 (OR BETTER) FOR INTERIOR LOCATIONS AND NEMA 3 (OR BETTER) FOR EXTERIOR LOCATIONS.
25. METAL RECEPTACLE, SWITCH AND DEVICE BOXES SHALL BE GALVANIZED, EPOXY-COATED OR NON-CORRODING; SHALL MEET OR EXCEED UL 514A AND NEMA OS 1 AND BE RATED NEMA 1 (OR BETTER) FOR INTERIOR LOCATIONS AND WEATHER PROTECTED (WP OR BETTER) FOR EXTERIOR LOCATIONS.
26. NONMETALLIC RECEPTACLE, SWITCH AND DEVICE BOXES SHALL MEET OR EXCEED NEMA OS 2 (NEWEST REVISION) AND BE RATED NEMA 1 (OR BETTER) FOR INTERIOR LOCATIONS AND WEATHER PROTECTED (WP OR BETTER) FOR EXTERIOR LOCATIONS.
27. THE CONTRACTOR SHALL NOTIFY AND OBTAIN NECESSARY AUTHORIZATION FROM THE CARRIER AND/OR DISH WIRELESS, LLC. AND TOWER OWNER BEFORE COMMENCING WORK ON THE AC POWER DISTRIBUTION PANELS.
28. THE CONTRACTOR SHALL PROVIDE NECESSARY TAGGING ON THE BREAKERS, CABLES AND DISTRIBUTION PANELS IN ACCORDANCE WITH THE APPLICABLE CODES AND STANDARDS TO SAFEGUARD LIFE AND PROPERTY.
29. INSTALL LAMICOID LABEL ON THE METER CENTER TO SHOW "DISH WIRELESS, LLC."
30. ALL EMPTY/SPARE CONDUITS THAT ARE INSTALLED ARE TO HAVE A METERED MULE TAPE PULL CORD INSTALLED.



5701 SOUTH SANTA FE DRIVE  
LITTLETON, CO 80120



**NB+C ENGINEERING SERVICES, LLC.**

100 APOLLO DRIVE  
SUITE 303  
CHELMSFORD, MA 01824  
(978) 856-8308



IT IS A VIOLATION OF LAW FOR ANY PERSON, UNLESS THEY ARE ACTING UNDER THE DIRECTION OF A LICENSED PROFESSIONAL ENGINEER, TO ALTER THIS DOCUMENT.

DRAWN BY:	CHECKED BY:	APPROVED BY:
CWE	NSB	DRG

RFDS REV #: 1

**CONSTRUCTION DOCUMENTS**

SUBMITTALS		
REV	DATE	DESCRIPTION
0	01/20/22	ISSUED FOR CONSTRUCTION
1	06/27/23	UTILITY ROUTES REVISED

A&E PROJECT NUMBER  
**100753**

DISH WIRELESS, LLC.  
PROJECT INFORMATION  
**BOBOS00343A**

1815 MASSACHUSETTS AVE.  
CAMBRIDGE, MA 02140

SHEET TITLE  
**GENERAL NOTES**

SHEET NUMBER  
**GN-3**

**GROUNDING NOTES:**

1. ALL GROUND ELECTRODE SYSTEMS (INCLUDING TELECOMMUNICATION, RADIO, LIGHTNING PROTECTION AND AC POWER GES'S) SHALL BE BONDED TOGETHER AT OR BELOW GRADE, BY TWO OR MORE COPPER BONDING CONDUCTORS IN ACCORDANCE WITH THE NEC.
2. THE CONTRACTOR SHALL PERFORM IEEE FALL-OF-POTENTIAL RESISTANCE TO EARTH TESTING (PER IEEE 1100 AND 81) FOR GROUND ELECTRODE SYSTEMS, THE CONTRACTOR SHALL FURNISH AND INSTALL SUPPLEMENTAL GROUND ELECTRODES AS NEEDED TO ACHIEVE A TEST RESULT OF 5 OHMS OR LESS.
3. THE CONTRACTOR IS RESPONSIBLE FOR PROPERLY SEQUENCING GROUNDING AND UNDERGROUND CONDUIT INSTALLATION AS TO PREVENT ANY LOSS OF CONTINUITY IN THE GROUNDING SYSTEM OR DAMAGE TO THE CONDUIT AND PROVIDE TESTING RESULTS.
4. METAL CONDUIT AND TRAY SHALL BE GROUNDED AND MADE ELECTRICALLY CONTINUOUS WITH LISTED BONDING FITTINGS OR BY BONDING ACROSS THE DISCONTINUITY WITH #6 COPPER WIRE UL APPROVED GROUNDING TYPE CONDUIT CLAMPS.
5. METAL RACEWAY SHALL NOT BE USED AS THE NEC REQUIRED EQUIPMENT GROUND CONDUCTOR. STRANDED COPPER CONDUCTORS WITH GREEN INSULATION, SIZED IN ACCORDANCE WITH THE NEC, SHALL BE FURNISHED AND INSTALLED WITH THE POWER CIRCUITS TO BTS EQUIPMENT.
6. EACH CABINET FRAME SHALL BE DIRECTLY CONNECTED TO THE MASTER GROUND BAR WITH GREEN INSULATED SUPPLEMENTAL EQUIPMENT GROUND WIRES, #6 STRANDED COPPER OR LARGER FOR INDOOR BTS; #2 BARE SOLID TINNED COPPER FOR OUTDOOR BTS.
7. CONNECTIONS TO THE GROUND BUS SHALL NOT BE DOUBLED UP OR STACKED BACK TO BACK CONNECTIONS ON OPPOSITE SIDE OF THE GROUND BUS ARE PERMITTED.
8. ALL EXTERIOR GROUND CONDUCTORS BETWEEN EQUIPMENT/GROUND BARS AND THE GROUND RING SHALL BE #2 SOLID TINNED COPPER UNLESS OTHERWISE INDICATED.
9. ALUMINUM CONDUCTOR OR COPPER CLAD STEEL CONDUCTOR SHALL NOT BE USED FOR GROUNDING CONNECTIONS.
10. USE OF 90° BENDS IN THE PROTECTION GROUNDING CONDUCTORS SHALL BE AVOIDED WHEN 45° BENDS CAN BE ADEQUATELY SUPPORTED.
11. EXOTHERMIC WELDS SHALL BE USED FOR ALL GROUNDING CONNECTIONS BELOW GRADE.
12. ALL GROUND CONNECTIONS ABOVE GRADE (INTERIOR AND EXTERIOR) SHALL BE FORMED USING HIGH PRESS CRIMPS.
13. COMPRESSION GROUND CONNECTIONS MAY BE REPLACED BY EXOTHERMIC WELD CONNECTIONS.
14. ICE BRIDGE BONDING CONDUCTORS SHALL BE EXOTHERMICALLY BONDED OR BOLTED TO THE BRIDGE AND THE TOWER GROUND BAR.
15. APPROVED ANTIOXIDANT COATINGS (i.e. CONDUCTIVE GEL OR PASTE) SHALL BE USED ON ALL COMPRESSION AND BOLTED GROUND CONNECTIONS.
16. ALL EXTERIOR GROUND CONNECTIONS SHALL BE COATED WITH A CORROSION RESISTANT MATERIAL.
17. MISCELLANEOUS ELECTRICAL AND NON-ELECTRICAL METAL BOXES, FRAMES AND SUPPORTS SHALL BE BONDED TO THE GROUND RING, IN ACCORDANCE WITH THE NEC.
18. BOND ALL METALLIC OBJECTS WITHIN 6 ft OF MAIN GROUND RING WITH (1) #2 BARE SOLID TINNED COPPER GROUND CONDUCTOR.
19. GROUND CONDUCTORS USED FOR THE FACILITY GROUNDING AND LIGHTNING PROTECTION SYSTEMS SHALL NOT BE ROUTED THROUGH METALLIC OBJECTS THAT FORM A RING AROUND THE CONDUCTOR, SUCH AS METALLIC CONDUITS, METAL SUPPORT CLIPS OR SLEEVES THROUGH WALLS OR FLOORS. WHEN IT IS REQUIRED TO BE HOUSED IN CONDUIT TO MEET CODE REQUIREMENTS OR LOCAL CONDITIONS, NON-METALLIC MATERIAL SUCH AS PVC CONDUIT SHALL BE USED. WHERE USE OF METAL CONDUIT IS UNAVOIDABLE (i.e., NONMETALLIC CONDUIT PROHIBITED BY LOCAL CODE) THE GROUND CONDUCTOR SHALL BE BONDED TO EACH END OF THE METAL CONDUIT.
20. ALL GROUNDS THAT TRANSITION FROM BELOW GRADE TO ABOVE GRADE MUST BE #2 BARE SOLID TINNED COPPER IN 3/4" NON-METALLIC, FLEXIBLE CONDUIT FROM 24" BELOW GRADE TO WITHIN 3" TO 6" OF CAD-WELD TERMINATION POINT. THE EXPOSED END OF THE CONDUIT MUST BE SEALED WITH SILICONE CAULK. (ADD TRANSITIONING GROUND STANDARD DETAIL AS WELL).
21. BUILDINGS WHERE THE MAIN GROUNDING CONDUCTORS ARE REQUIRED TO BE ROUTED TO GRADE, THE CONTRACTOR SHALL ROUTE TWO GROUNDING CONDUCTORS FROM THE ROOFTOP, TOWERS, AND WATER TOWERS GROUNDING RING, TO THE EXISTING GROUNDING SYSTEM, THE GROUNDING CONDUCTORS SHALL NOT BE SMALLER THAN 2/0 COPPER. ROOFTOP GROUNDING RING SHALL BE BONDED TO THE EXISTING GROUNDING SYSTEM, THE BUILDING STEEL COLUMNS, LIGHTNING PROTECTION SYSTEM, AND BUILDING MAIN WATER LINE (FERROUS OR NONFERROUS METAL PIPING ONLY). DO NOT ATTACH GROUNDING TO FIRE SPRINKLER SYSTEM PIPES.



5701 SOUTH SANTA FE DRIVE  
LITTLETON, CO 80120



**NB+C ENGINEERING SERVICES, LLC.**

100 APOLLO DRIVE  
SUITE 303  
CHELMSFORD, MA 01824  
(978) 856-8308



IT IS A VIOLATION OF LAW FOR ANY PERSON, UNLESS THEY ARE ACTING UNDER THE DIRECTION OF A LICENSED PROFESSIONAL ENGINEER, TO ALTER THIS DOCUMENT.

DRAWN BY:	CHECKED BY:	APPROVED BY:
CWE	NSB	DRG

RFDS REV #: 1

**CONSTRUCTION DOCUMENTS**

SUBMITTALS		
REV	DATE	DESCRIPTION
0	01/20/22	ISSUED FOR CONSTRUCTION
1	06/27/23	UTILITY ROUTES REVISED

A&E PROJECT NUMBER  
**100753**

DISH WIRELESS, LLC.  
PROJECT INFORMATION  
**BOBOS00343A**  
**1815 MASSACHUSETTS AVE.**  
**CAMBRIDGE, MA 02140**

SHEET TITLE  
**GENERAL NOTES**

SHEET NUMBER  
**GN-4**





DISH WIRELESS, LLC. SITE ID:

**BOBOS00343A**

DISH WIRELESS, LLC. SITE ADDRESS:

**1815 MASSACHUSETTS AVE  
CAMBRIDGE, MA 02140**

**MASSACHUSETTS CODE COMPLIANCE**

ALL WORK SHALL BE PERFORMED AND MATERIALS INSTALLED IN ACCORDANCE WITH THE CURRENT EDITIONS OF THE FOLLOWING CODES AS ADOPTED BY THE LOCAL GOVERNING AUTHORITIES. NOTHING IN THESE PLANS IS TO BE CONSTRUED TO PERMIT WORK NOT CONFORMING TO THESE CODES:

CODE TYPE	CODE
BUILDING	MA STATE BUILDING CODE, 9TH EDITION (780 CMR)/2015 IBC W/ AMENDMENTS
MECHANICAL	MECHANICAL CODE 2015 OF MASSACHUSETTS/2015 IMC W/ AMENDMENTS
ELECTRICAL	MA ELECTRICAL CODE/2020 NEC W/ AMENDMENTS

**SHEET INDEX**

SHEET NO.	SHEET TITLE
T-1	TITLE SHEET
Z-1	ZONING PLAN
A-1	BUILDING PLAN
A-2	ANTENNA PLAN, ELEVATION AND SCHEDULE
A-3	BUILDING ELEVATION
A-4	EQUIPMENT PLATFORM AND H-FRAME DETAILS
A-5	EQUIPMENT DETAILS
A-6	EQUIPMENT DETAILS
E-1	ELECTRICAL/FIBER ROUTE PLAN AND NOTES
E-2	ELECTRICAL DETAILS
E-3	ELECTRICAL ONE-LINE, FAULT CALCS & PANEL SCHEDULE
G-1	GROUNDING PLANS AND NOTES
G-2	GROUNDING DETAILS
G-3	GROUNDING DETAILS
RF-1	RF CABLE COLOR CODE
GN-1	LEGEND AND ABBREVIATIONS
GN-2	GENERAL NOTES
GN-3	GENERAL NOTES
GN-4	GENERAL NOTES

**SCOPE OF WORK**

THIS IS NOT AN ALL INCLUSIVE LIST. CONTRACTOR SHALL UTILIZE SPECIFIED EQUIPMENT PART OR ENGINEER APPROVED EQUIVALENT. CONTRACTOR SHALL VERIFY ALL NEEDED EQUIPMENT TO PROVIDE A FUNCTIONAL SITE. THE PROJECT GENERALLY CONSISTS OF THE FOLLOWING:

- SECTOR SCOPE OF WORK:
- INSTALL (3) PROPOSED PANEL ANTENNAS (1 PER SECTOR)
  - INSTALL (3) PROPOSED ANTENNA MOUNTS (1 PER SECTOR)
  - INSTALL PROPOSED JUMPERS
  - INSTALL (6) PROPOSED RRUs (2 PER SECTOR)
  - INSTALL (3) PROPOSED OVER VOLTAGE PROTECTION DEVICE (OVP) (1 PER SECTOR)
  - INSTALL (3) PROPOSED DC POWER CABLES (1 PER SECTOR)
  - INSTALL (3) PROPOSED FIBER TRUNKS (1 PER SECTOR)

- ROOFTOP SCOPE OF WORK:
- INSTALL (1) PROPOSED METAL PLATFORM WITH H-FRAME
  - INSTALL (1) PROPOSED CABLE LADDER TRAY AND CABLE TRAY
  - INSTALL (1) PROPOSED BBU IN CABINET
  - INSTALL (1) PROPOSED EQUIPMENT CABINET
  - INSTALL (1) PROPOSED NEMA 3 TELCO-FIBER BOX
  - INSTALL (1) PROPOSED GPS UNIT
  - INSTALL (1) PROPOSED GROUNDING CONDUIT
  - INSTALL (1) PROPOSED POWER CONDUIT
  - INSTALL (1) PROPOSED FIBER CONDUIT

**SITE INFORMATION**

PROPERTY OWNER: LESLEY COLLEGE  
 ADDRESS: 1815 MASSACHUSETTS AVE  
 CAMBRIDGE, MA 02140

TOWER TYPE: ROOFTOP

TOWER CO SITE ID: N/A

TOWER APP NUMBER: N/A

COUNTY: MIDDLESEX

LATITUDE (NAD 83): 42° 23' 13.9668" N  
 42.387213 N

LONGITUDE (NAD 83): 71° 07' 06.9600" W  
 71.118600 W

ZONING JURISDICTION: CITY OF CAMBRIDGE, MA

ZONING DISTRICT: SPECIAL PERMIT

PARCEL NUMBER: 000152-000000-000051E

OCCUPANCY GROUP: U

CONSTRUCTION TYPE: II-B

POWER COMPANY: EVERSOURCE/NSTAR

TELEPHONE COMPANY: COMCAST

**PROJECT DIRECTORY**

APPLICANT: DISH WIRELESS, LLC.  
 5701 SOUTH SANTA FE DRIVE  
 LITTLETON, CO 80120

TOWER MANAGER: LESLEY COLLEGE  
 1815 MASSACHUSETTS AVE  
 CAMBRIDGE, MA 02140  
 (781) 431-1039

SITE DESIGNER: NB+C ENGINEERING SERVICES, LLC  
 100 APOLLO DRIVE, SUITE 303  
 CHELMSFORD, MA 01824  
 (978) 856-8308

SITE ACQUISITION: ANDREW GORHAM  
 AGORHAM@NBCLLC.COM

CONSTRUCTION MANAGER: AARON CHANDLER  
 AARON.CHANDLER@DISH.COM

RF ENGINEER: VICTORIEN NDOUNOU  
 VICTORIEN.NDOUNOU@DISH.COM



5701 SOUTH SANTA FE DRIVE  
LITTLETON, CO 80120



**NB+C ENGINEERING SERVICES, LLC.**

100 APOLLO DRIVE  
SUITE 303  
CHELMSFORD, MA 01824  
(978) 856-8308



IT IS A VIOLATION OF LAW FOR ANY PERSON, UNLESS THEY ARE ACTING UNDER THE DIRECTION OF A LICENSED PROFESSIONAL ENGINEER, TO ALTER THIS DOCUMENT.

DRAWN BY:	CHECKED BY:	APPROVED BY:
CWE	NSB	DRG

RFDS REV #: 1

**CONSTRUCTION DOCUMENTS**

SUBMITTALS		
REV	DATE	DESCRIPTION
0	01/20/22	ISSUED FOR CONSTRUCTION
1	06/27/23	UTILITY ROUTES REVISED

A&E PROJECT NUMBER  
**100753**

DISH WIRELESS, LLC.  
PROJECT INFORMATION  
**BOBOS00343A**

1815 MASSACHUSETTS AVE.  
CAMBRIDGE, MA 02140

SHEET TITLE  
**TITLE SHEET**

SHEET NUMBER  
**T-1**

**SITE PHOTO**



**UNDERGROUND SERVICE ALERT - 811 DIG SAFE**  
 UTILITY NOTIFICATION CENTER OF MASSACHUSETTS  
 (888) 344-7233  
 WWW.DIGSAFE.COM



CALL 3 WORKING DAYS UTILITY NOTIFICATION PRIOR TO CONSTRUCTION

**GENERAL NOTES**

THE FACILITY IS UNMANNED AND NOT FOR HUMAN HABITATION. A TECHNICIAN WILL VISIT THE SITE AS REQUIRED FOR ROUTINE MAINTENANCE. THE PROJECT WILL NOT RESULT IN ANY SIGNIFICANT DISTURBANCE OR EFFECT ON DRAINAGE. NO SANITARY SEWER SERVICE, POTABLE WATER, OR TRASH DISPOSAL IS REQUIRED AND NO COMMERCIAL SIGNAGE IS PROPOSED.

**11"x17" PLOT WILL BE HALF SCALE UNLESS OTHERWISE NOTED**

CONTRACTOR SHALL VERIFY ALL PLANS, EXISTING DIMENSIONS, AND CONDITIONS ON THE JOB SITE, AND SHALL IMMEDIATELY NOTIFY THE ENGINEER IN WRITING OF ANY DISCREPANCIES BEFORE PROCEEDING WITH THE WORK.

**DIRECTIONS**

**DIRECTIONS FROM LOGAN AIRPORT:**

DESTINATION IS 7.5 MILES FROM AIRPORT. THIS ROUTE HAS TOLLS. GET ON MA-1A SOUTH (FROM AIRPORT RD - ARRIVAL LEVEL, KEEP RIGHT AND FOLLOW SIGNS FOR MA-1A S / I-93 N / SUMNER TUNNEL / GOV'T CENTER). ON MA-1A S, KEEP RIGHT, FOLLOW SIGNS FOR I-93 N, AND MERGE ONTO I-93 N. ON I-93 N, TAKE EXIT 20 (MA 99 / SULLIVAN SQUARE / SOMERVILLE). TAKE FIRST LEFT (CAMBRIDGE STREET). FOR NEXT 0.7 MILES, CAMBRIDGE STREET BECOMES WASHINGTON STREET, WHICH TURNS SLIGHTLY LEFT AND BECOMES PROSPECT STREET. AFTER 200 FEET, TURN RIGHT ONTO SOMERVILLE AVE / UNION SQUARE. AFTER 0.6 MILES, TAKE SLIGHT LEFT ONTO WASHINGTON STREET. AFTER 0.7 MILES, TURN RIGHT ONTO BEACON STREET. AFTER 0.8 MILES, TURN LEFT ONTO ROSELAND STREET. DESTINATION IS AT END OF ROSELAND STREET ON RIGHT SIDE.

**VICINITY MAP**

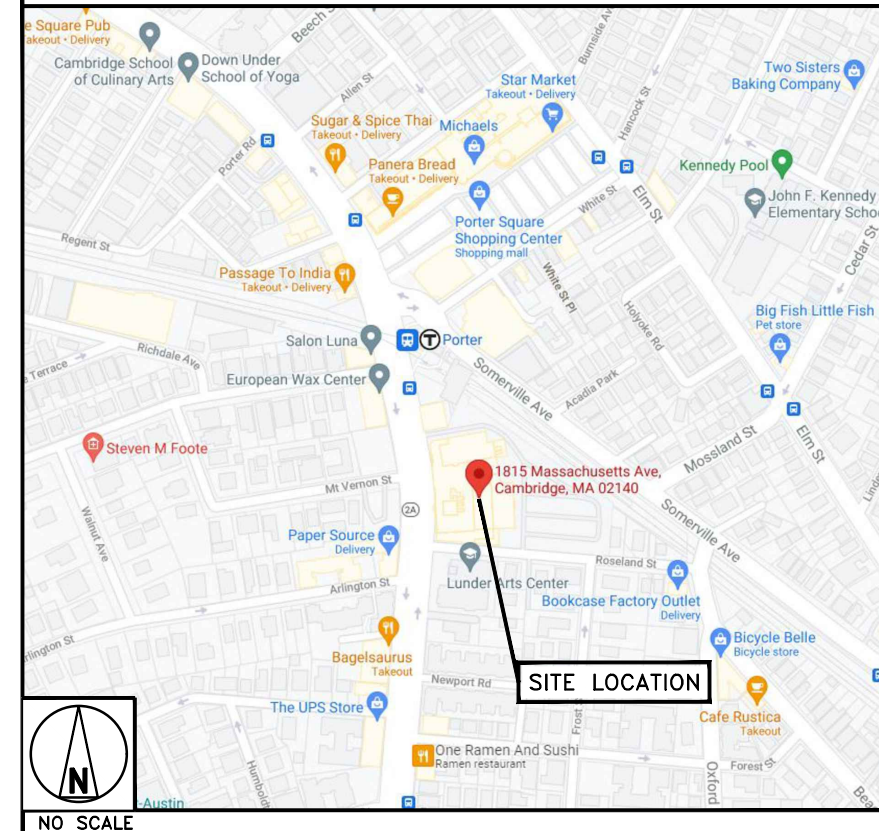

NO SCALE



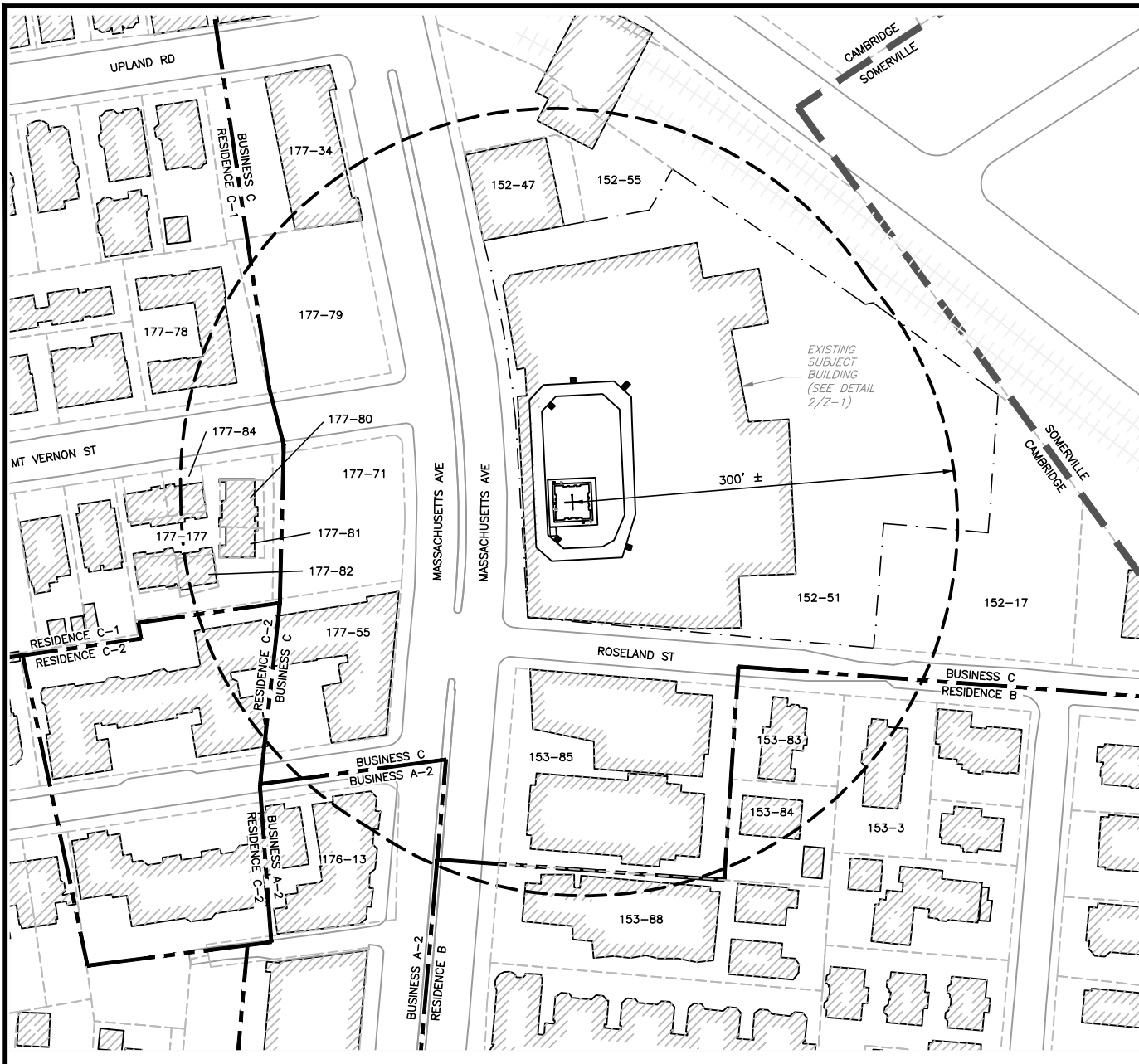

**SITE PLAN**

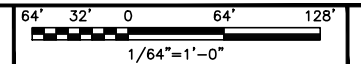

1

LEGEND	
	PROPERTY LINE - SUBJECT PARCEL
	PROPERTY LINE - OTHER PARCELS
	ZONING DISTRICT - BOUNDARY LINE
	ZONING DISTRICT - NAME
	CITY/TOWN - BOUNDARY LINE
	EXISTING ROAD
	EXISTING TRAIN TRACKS
	EXISTING BUILDING



ZONING INFORMATION		
ZONING JURISDICTION:	CITY OF CAMBRIDGE	
ZONING DISTRICT:	BUSINESS C (BC)	
ASSESSORS MAP:	MAP 152 LOT 51	
PROPOSED USE:	WIRELESS COMMUNICATION FACILITY	
DIMENSION:	REQUIRED MINIMUM	PROPOSED CHANGE
LOT AREA	-	NO CHANGE
LOT FRONTAGE	-	NO CHANGE
FRONT YARD SETBACK*	-	NO CHANGE
SIDE YARD SETBACK*	-	NO CHANGE
REAR YARD SETBACK*	20 FT	NO CHANGE
* DIMENSIONS MEASURED FROM THE CLOSEST POINT OF EQUIPMENT TO NEAREST LOT LINE.		
NOTES:		
1. PLOT PLAN BASED ON TAX MAPS FROM THE CITY OF CAMBRIDGE.		

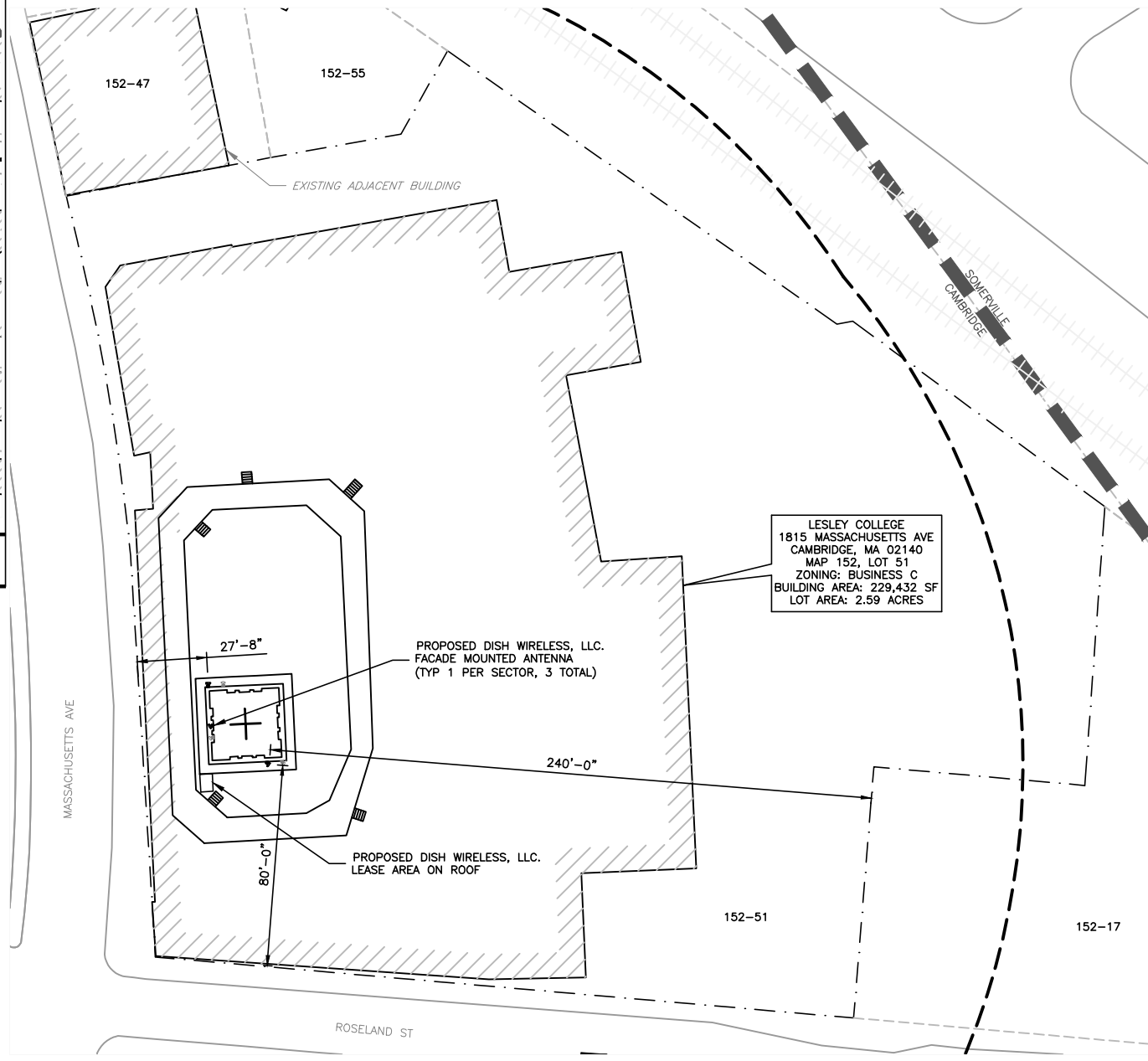

**ENLARGED SITE PLAN**

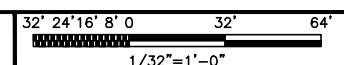

2



5701 SOUTH SANTA FE DRIVE  
LITTLETON, CO 80120



**NB+C ENGINEERING SERVICES, LLC.**

100 APOLLO DRIVE  
SUITE 303  
CHELMSFORD, MA 01824  
(978) 856-8308



IT IS A VIOLATION OF LAW FOR ANY PERSON, UNLESS THEY ARE ACTING UNDER THE DIRECTION OF A LICENSED PROFESSIONAL ENGINEER, TO ALTER THIS DOCUMENT.

DRAWN BY:	CHECKED BY:	APPROVED BY:
CWE	NSB	DRG

RFDS REV #: 1

**CONSTRUCTION DOCUMENTS**

SUBMITTALS		
REV	DATE	DESCRIPTION
0	01/20/22	ISSUED FOR CONSTRUCTION
1	06/27/23	UTILITY ROUTES REVISED

A&E PROJECT NUMBER  
**100753**

DISH WIRELESS, LLC.  
PROJECT INFORMATION  
**BOBOS00343A**

1815 MASSACHUSETTS AVE.  
CAMBRIDGE, MA 02140

SHEET TITLE  
**ZONING PLAN**

SHEET NUMBER  
**Z-1**

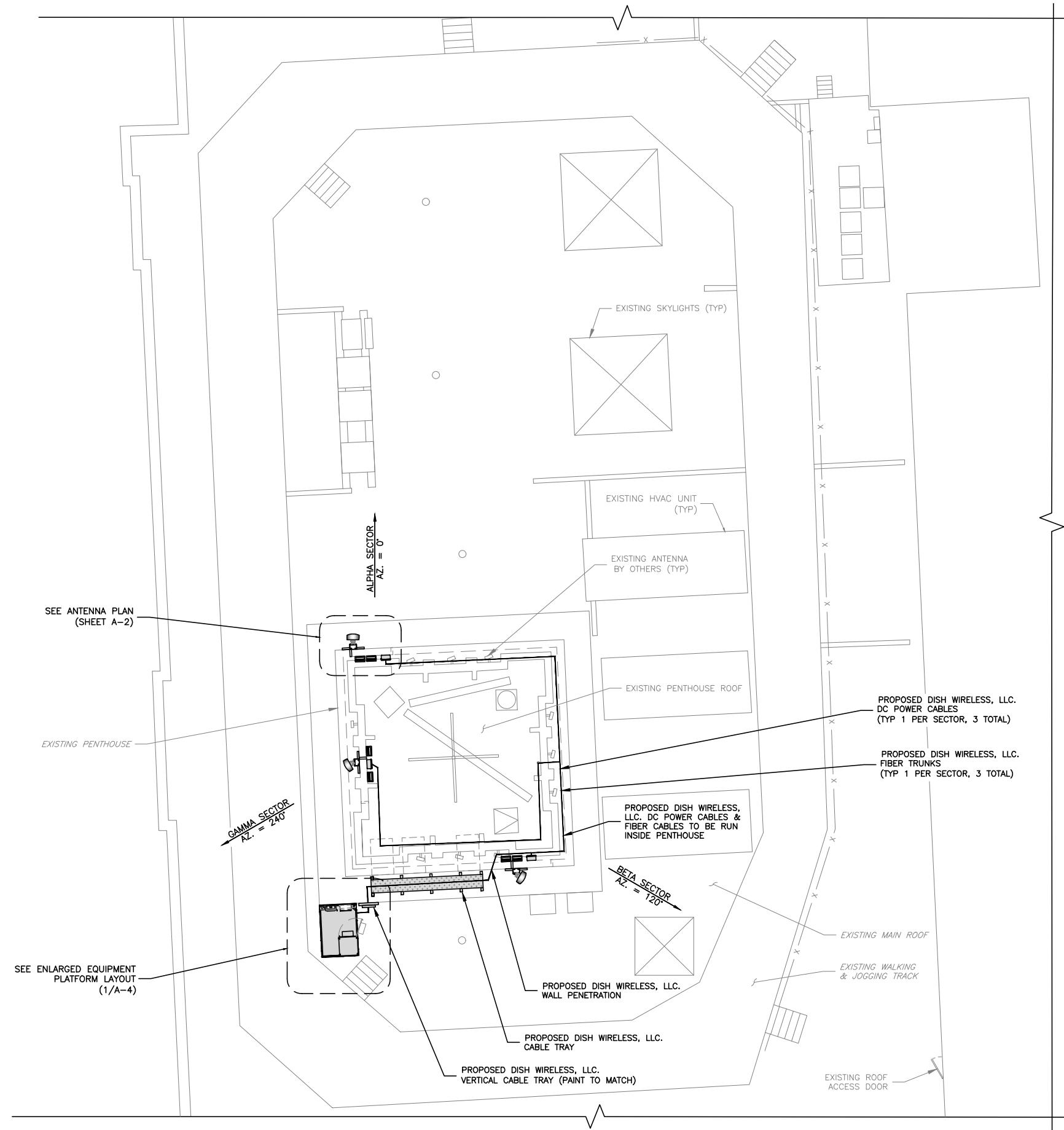

**NOTES**

1. CONTRACTOR SHALL FIELD VERIFY ALL DIMENSIONS.
2. CONTRACTOR SHALL MAINTAIN A 10'-0" MINIMUM SEPARATION BETWEEN THE PROPOSED GPS UNIT, TRANSMITTING ANTENNAS AND EXISTING GPS UNITS.
3. CONTRACTOR TO VERIFY WITH DISH WIRELESS, LLC. C.M. THE LOCATION OF THE POWER AND FIBER SOURCE PRIOR TO CONSTRUCTION.
4. UTILITY RUBBER MAT TO BE INSTALLED UNDER ALL DISH WIRELESS, LLC. EQUIPMENT THAT IS RESTING ON OR AFFIXED TO ROOF MEMBRANE



5701 SOUTH SANTA FE DRIVE  
LITTLETON, CO 80120



**NB+C ENGINEERING SERVICES, LLC.**

100 APOLLO DRIVE  
SUITE 303  
CHELMSFORD, MA 01824  
(978) 856-8308



IT IS A VIOLATION OF LAW FOR ANY PERSON, UNLESS THEY ARE ACTING UNDER THE DIRECTION OF A LICENSED PROFESSIONAL ENGINEER, TO ALTER THIS DOCUMENT.

DRAWN BY:	CHECKED BY:	APPROVED BY:
CWE	NSB	DRG

RFDS REV #: 1

**CONSTRUCTION DOCUMENTS**

SUBMITTALS		
REV	DATE	DESCRIPTION
0	01/20/22	ISSUED FOR CONSTRUCTION
1	06/27/23	UTILITY ROUTES REVISED

A&E PROJECT NUMBER  
**100753**

DISH WIRELESS, LLC.  
PROJECT INFORMATION  
**BOBOS00343A**

1815 MASSACHUSETTS AVE.  
CAMBRIDGE, MA 02140

SHEET TITLE  
**BUILDING PLAN**

SHEET NUMBER  
**A-1**

**BUILDING PLAN**

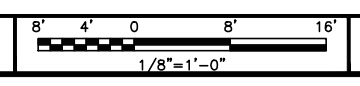

**NOTES**

1. CONTRACTOR SHALL FIELD VERIFY ALL DIMENSIONS.
2. ANTENNA AND MW DISH SPECIFICATIONS REFER TO ANTENNA SCHEDULE AND TO FINAL CONSTRUCTION RFDS FOR ALL RF DETAILS
3. EXISTING EQUIPMENT AND FENCE OMITTED FOR CLARITY.
4. ALPHA SECTOR SHOWN TYPICAL FOR BETA AND GAMMA SECTORS.

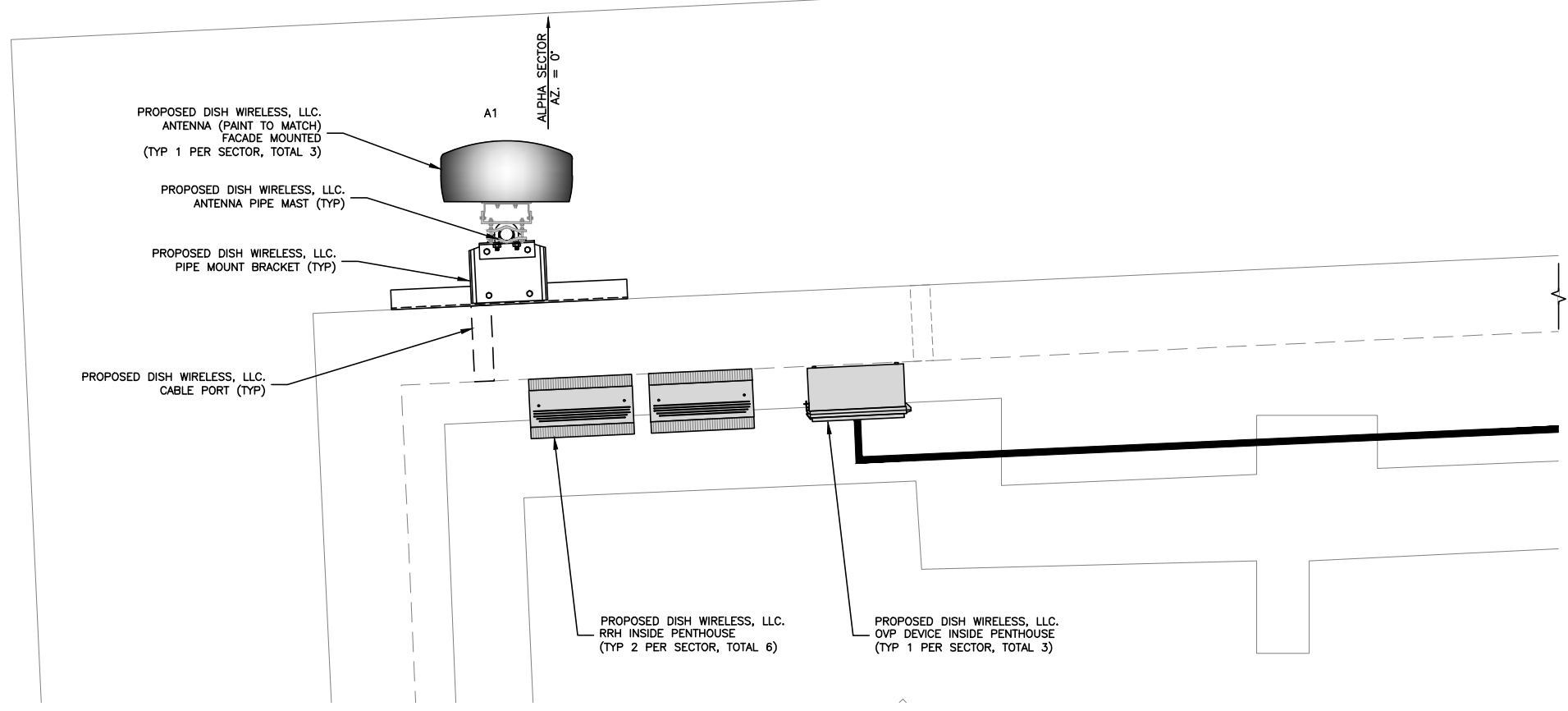

**ANTENNA PLAN (TYPICAL PER SECTOR)**

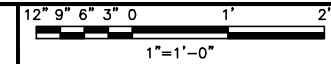

1

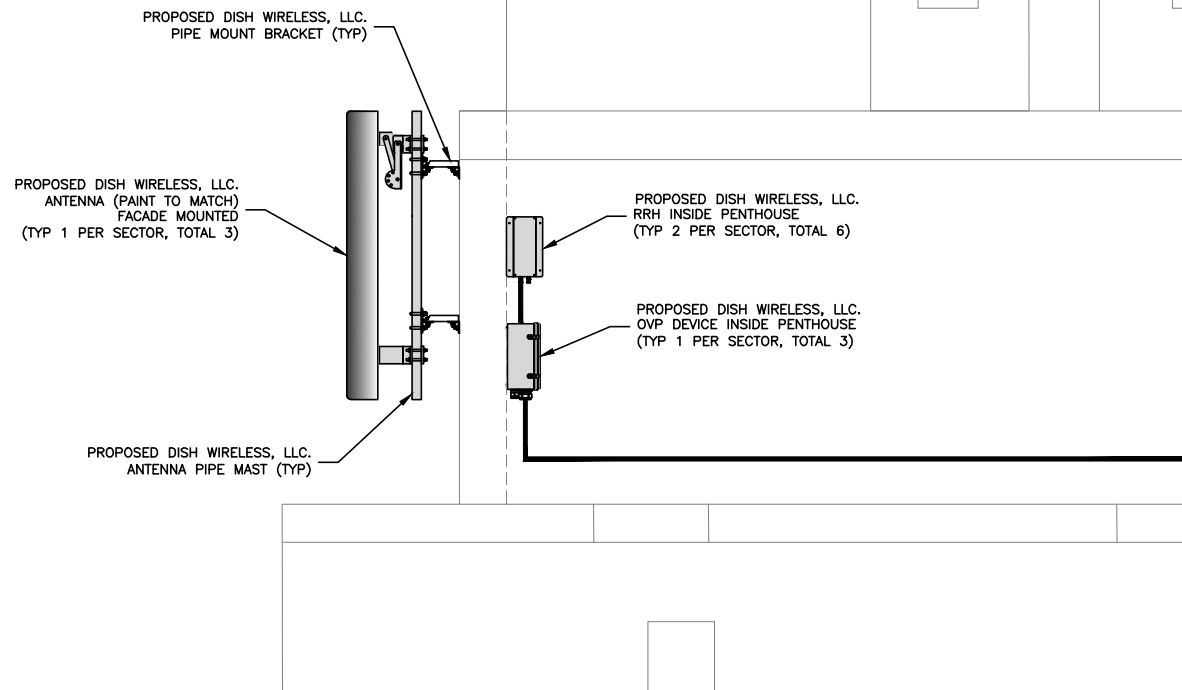

**ANTENNA ELEVATION**

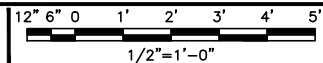

2

SECTOR POS.	ANTENNA					TRANSMISSION CABLE FEED LINE TYPE AND LENGTH	RRH			OVP MANUFACTURER MODEL
	EXISTING OR PROPOSED	MANUFACTURER - MODEL NUMBER	TECH	AZIMUTH	RAD CENTER		MANUFACTURER - MODEL NUMBER	TECH	POS.	
A1	PROPOSED	JMA - MX08FR0665-21	5G	0°	63'-10"	(1) 6AWG DC POWER CABLE (1) FIBER TRUNK (LENGTH: 130'±)	SAMSUNG - MID BAND SFG-ARR3KM01DL_RF4451D-70A	5G	A1	RAYCAP RDIC-3045-PF-48
A2	--	--	--	--	--		SAMSUNG - LOW BAND SFG-ARR3J601DL_RF4450T-71A	5G	A1	
A3	--	--	--	--	--		--	--	--	
B1	PROPOSED	JMA - MX08FR0665-21	5G	120°	63'-10"	(1) 6AWG DC POWER CABLE (1) FIBER TRUNK (LENGTH: 80'±)	SAMSUNG - MID BAND SFG-ARR3KM01DL_RF4451D-70A	5G	B1	RAYCAP RDIC-3045-PF-48
B2	--	--	--	--	--		SAMSUNG - LOW BAND SFG-ARR3J601DL_RF4450T-71A	5G	B1	
B3	--	--	--	--	--		--	--	--	
C1	PROPOSED	JMA - MX08FR0665-21	5G	240°	80'-0"	(1) 6AWG DC POWER CABLE (1) FIBER TRUNK (LENGTH: 160'±)	SAMSUNG - MID BAND SFG-ARR3KM01DL_RF4451D-70A	5G	C1	RAYCAP RDIC-3045-PF-48
C2	--	--	--	--	--		SAMSUNG - LOW BAND SFG-ARR3J601DL_RF4450T-71A	5G	C1	
C3	--	--	--	--	--		--	--	--	

- NOTES**
1. CONTRACTOR TO REFER TO FINAL CONSTRUCTION RFDS FOR ALL RF DETAILS.
  2. ANTENNA AND RRH MODELS MAY CHANGE DUE TO EQUIPMENT AVAILABILITY. ALL EQUIPMENT CHANGES MUST BE APPROVED AND REMAIN IN COMPLIANCE WITH THE PROPOSED DESIGN AND STRUCTURAL ANALYSES.

**ANTENNA SCHEDULE**

NO SCALE

3



5701 SOUTH SANTA FE DRIVE  
LITTLETON, CO 80120



**NB+C ENGINEERING SERVICES, LLC.**

100 APOLLO DRIVE  
SUITE 303  
CHELMSFORD, MA 01824  
(978) 856-8308



IT IS A VIOLATION OF LAW FOR ANY PERSON, UNLESS THEY ARE ACTING UNDER THE DIRECTION OF A LICENSED PROFESSIONAL ENGINEER, TO ALTER THIS DOCUMENT.

DRAWN BY: CWB  
CHECKED BY: NSB  
APPROVED BY: DRG

RFDS REV #: 1

**CONSTRUCTION DOCUMENTS**

SUBMITTALS		
REV	DATE	DESCRIPTION
0	01/20/22	ISSUED FOR CONSTRUCTION
1	06/27/23	UTILITY ROUTES REVISED

A&E PROJECT NUMBER  
**100753**

DISH WIRELESS, LLC.  
PROJECT INFORMATION  
**BOBOS00343A**

1815 MASSACHUSETTS AVE.  
CAMBRIDGE, MA 02140

SHEET TITLE  
**ANTENNA PLAN,  
ELEVATION AND SCHEDULE**

SHEET NUMBER  
**A-2**

**NOTES**

1. CONTRACTOR SHALL FIELD VERIFY ALL DIMENSIONS.
2. CONTRACTOR SHALL MAINTAIN A 10'-0" MINIMUM SEPARATION BETWEEN THE PROPOSED GPS UNIT, TRANSMITTING ANTENNAS AND EXISTING GPS UNITS.
3. EXISTING ABANDONED METROPCS CONDUITS TO BE EXTENDED FROM TERMINATIONS AT FLOOR LEVEL IN THE PENTHOUSE TO DISH EQUIPMENT CABINETS ALONG INTERIOR WALLS AS REQUIRED.



5701 SOUTH SANTA FE DRIVE  
LITTLETON, CO 80120



**NB+C ENGINEERING SERVICES, LLC.**

100 APOLLO DRIVE  
SUITE 303  
CHELMSFORD, MA 01824  
(978) 856-8308



IT IS A VIOLATION OF LAW FOR ANY PERSON, UNLESS THEY ARE ACTING UNDER THE DIRECTION OF A LICENSED PROFESSIONAL ENGINEER, TO ALTER THIS DOCUMENT.

DRAWN BY:	CHECKED BY:	APPROVED BY:
CWE	NSB	DRG

RFDS REV #: 1

**CONSTRUCTION DOCUMENTS**

SUBMITTALS		
REV	DATE	DESCRIPTION
0	01/20/22	ISSUED FOR CONSTRUCTION
1	06/27/23	UTILITY ROUTES REVISED

A&E PROJECT NUMBER  
**100753**

DISH WIRELESS, LLC.  
PROJECT INFORMATION  
**BOBOS00343A**

1815 MASSACHUSETTS AVE.  
CAMBRIDGE, MA 02140

SHEET TITLE  
**BUILDING ELEVATION**

SHEET NUMBER  
**A-3**

TOP OF FLAGPOLE / HIGHEST APPURTENANCE  
117'-0" AGL

TOP OF PENTHOUSE  
95'-0" AGL

PROPOSED DISH WIRELESS, LLC. ANTENNA (GAMMA SECTOR)  
RAD CENTER @ 80'-0" AGL

PROPOSED DISH WIRELESS, LLC. ANTENNA (ALPHA AND BETA SECTORS)  
RAD CENTER @ 63'-10" AGL

EXISTING BUILDING PARAPET  
44'-0" AGL

EXISTING BUILDING ROOF  
42'-0" AGL

EXISTING GROUND LEVEL  
0'-0" AGL

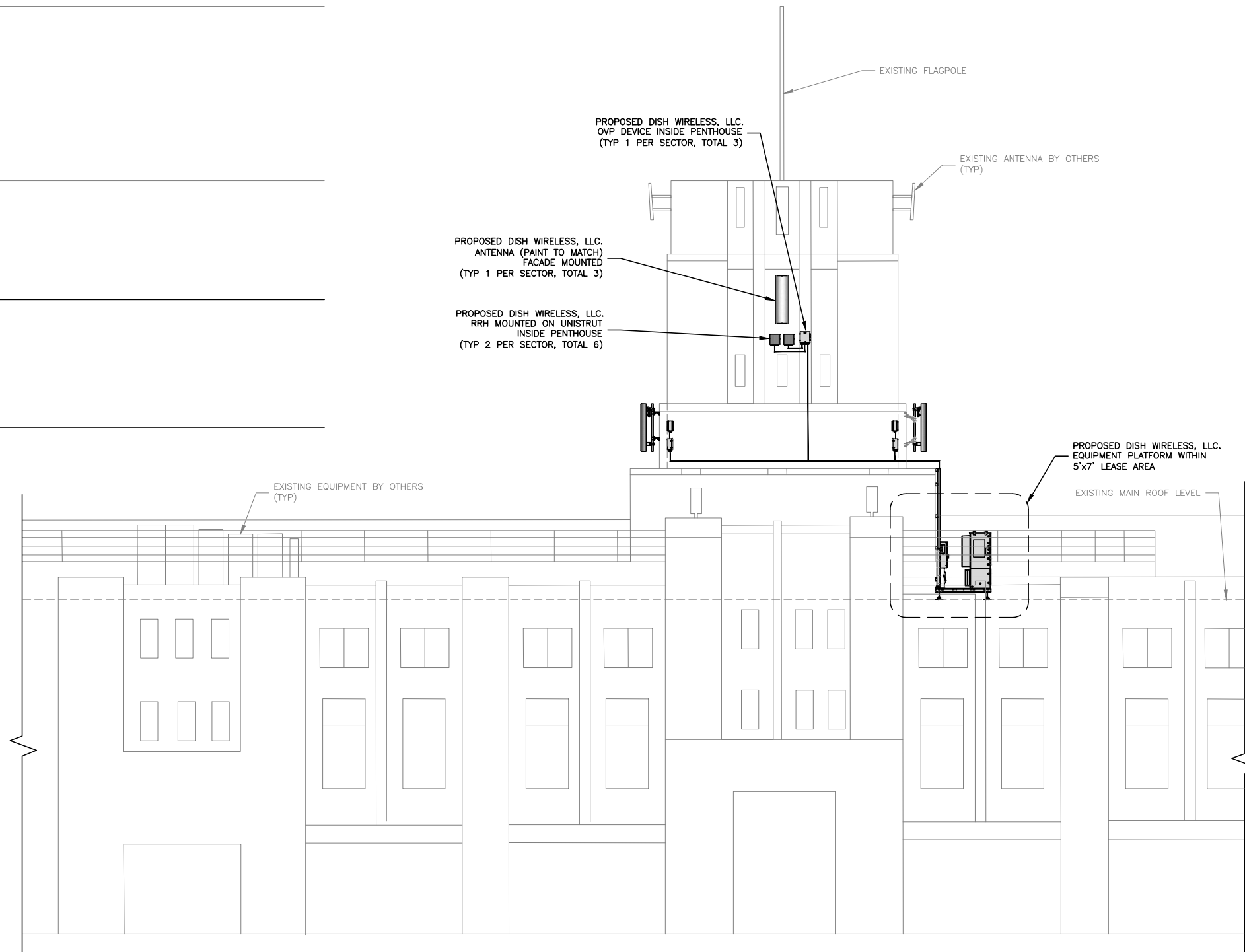

**BUILDING ELEVATION**

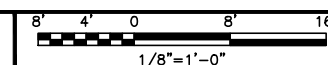



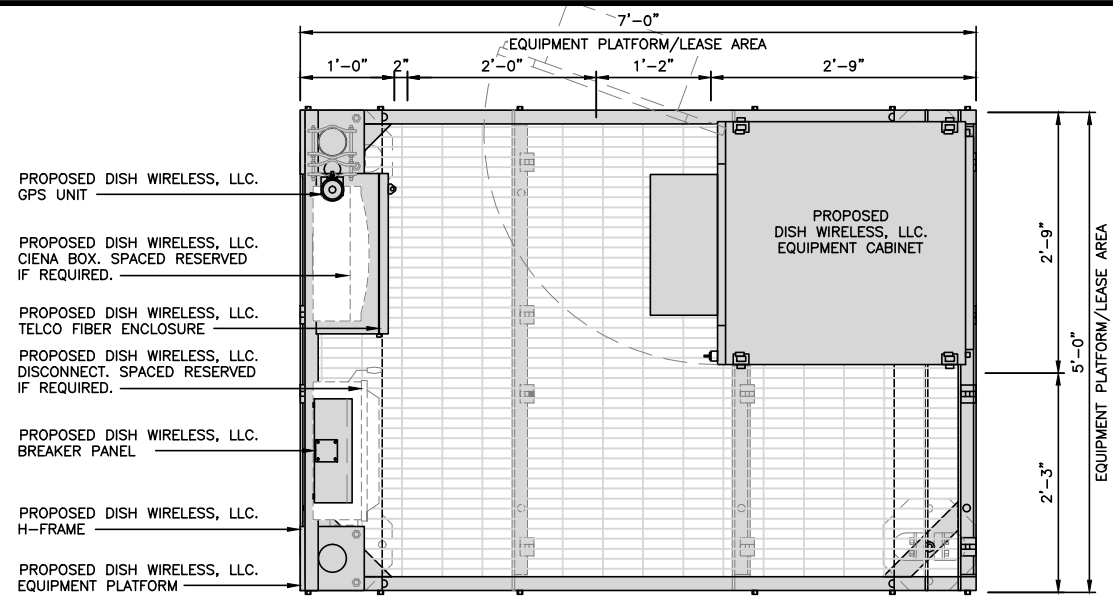

PLATFORM EQUIPMENT PLAN

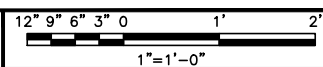

1

**NOTE**  
1. EQUIPMENT CABINET OMITTED FOR CLARITY

COMMSCOPE MTC4045LP 5X7 PLATFORM	
DIMENSIONS (HxWxD)	16"x84"x60"
TOTAL WEIGHT	423 LBS

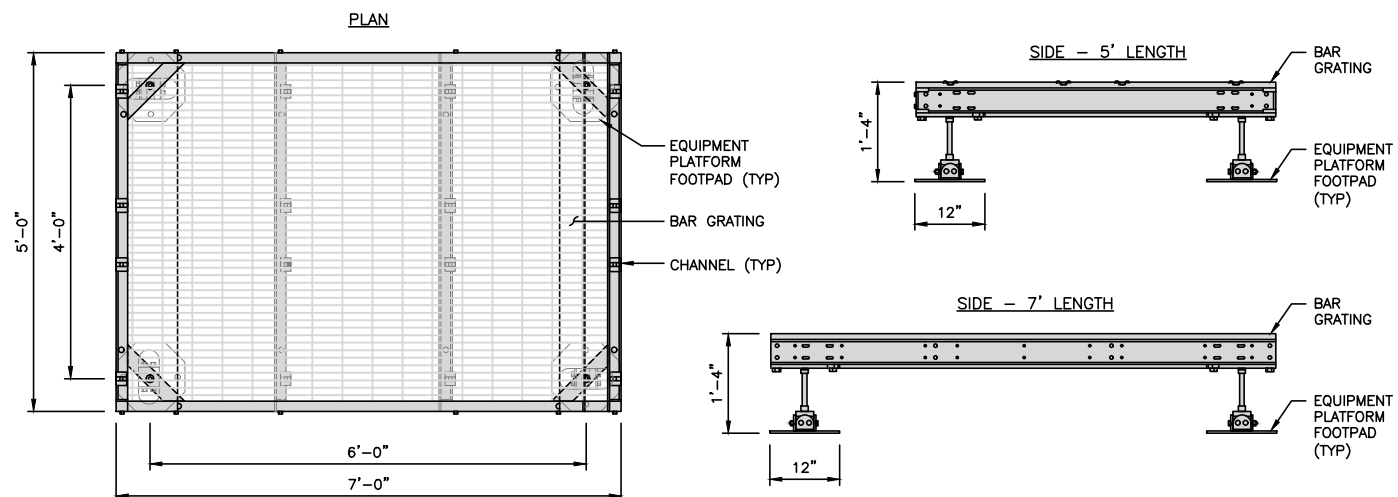

PLATFORM DETAIL

NO SCALE 2

KENWOOD T1701KT5-5S H-FRAME	
UNISTRUT/SUPPORT RAIL	5
WEIGHT/ VOLUME	173.6 LBS

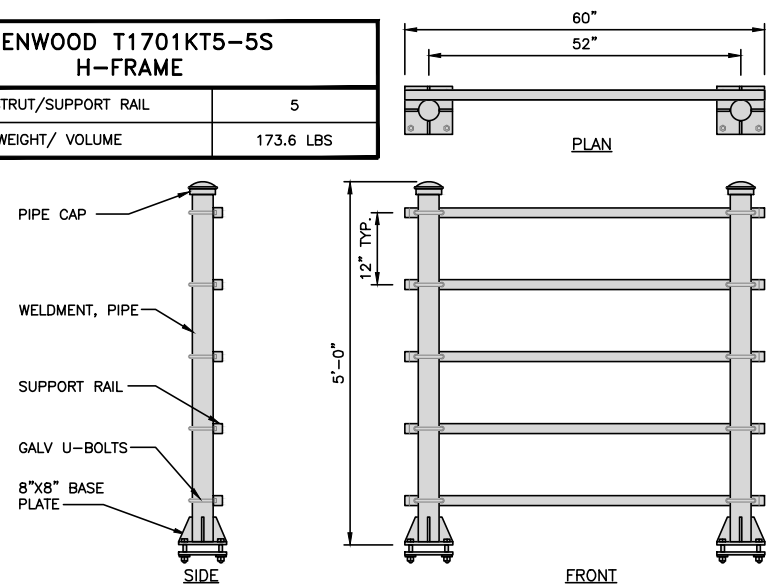

H-FRAME DETAIL

NO SCALE 3

UTILITY RUBBER MAT, BLACK	
DIMENSIONS	4'x 3'x 1/2"
WEIGHT/ VOLUME	36.5 LB AVERAGE
MATERIAL	100% RECYCLE RUBBER

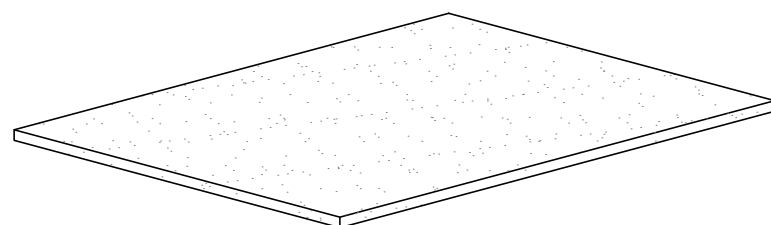

UTILITY RUBBER MAT DETAIL

NO SCALE 4

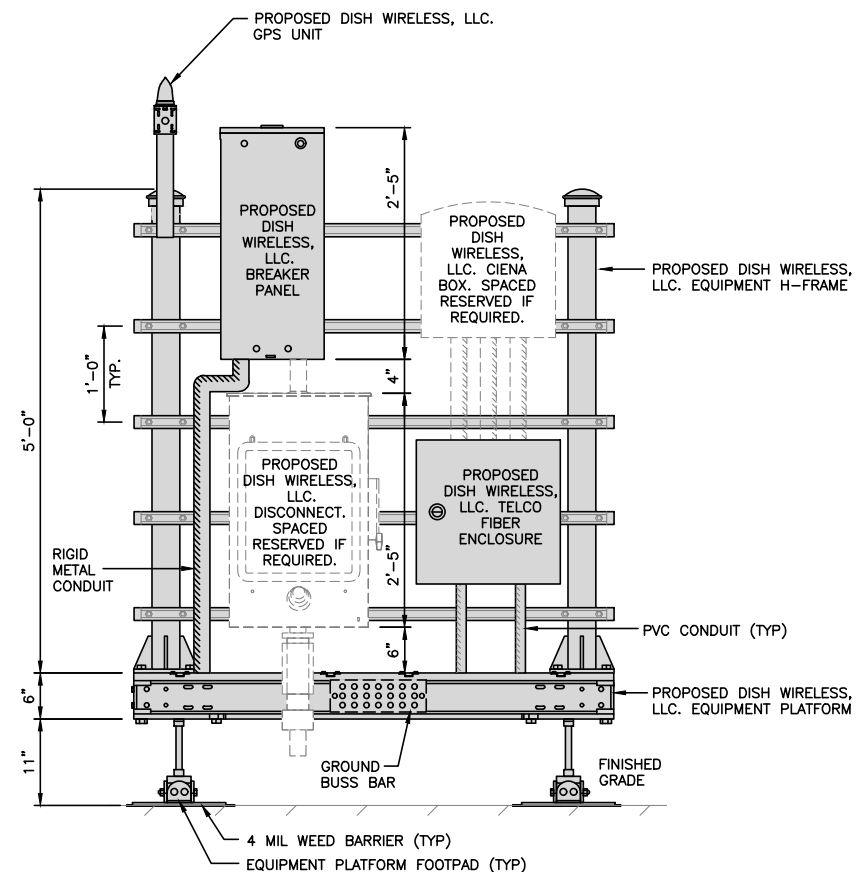

H-FRAME EQUIPMENT ELEVATION

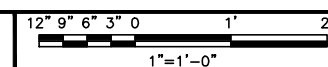

5

**dish**  
wireless.

5701 SOUTH SANTA FE DRIVE  
LITTLETON, CO 80120

**NB+C**  
TOTALLY COMMITTED.

NB+C ENGINEERING SERVICES, LLC.

100 APOLLO DRIVE  
SUITE 303  
CHELMSFORD, MA 01824  
(978) 856-8308



IT IS A VIOLATION OF LAW FOR ANY PERSON, UNLESS THEY ARE ACTING UNDER THE DIRECTION OF A LICENSED PROFESSIONAL ENGINEER, TO ALTER THIS DOCUMENT.

DRAWN BY: CHECKED BY: APPROVED BY:  
CWE NSB DRG

RFDS REV #: 1

**CONSTRUCTION DOCUMENTS**

SUBMITTALS		
REV	DATE	DESCRIPTION
0	01/20/22	ISSUED FOR CONSTRUCTION
1	06/27/23	UTILITY ROUTES REVISED

A&E PROJECT NUMBER  
100753

DISH WIRELESS, LLC.  
PROJECT INFORMATION  
BOBOS00343A

1815 MASSACHUSETTS AVE.  
CAMBRIDGE, MA 02140

SHEET TITLE  
EQUIPMENT PLATFORM AND  
H-FRAME DETAILS

SHEET NUMBER

**A-4**

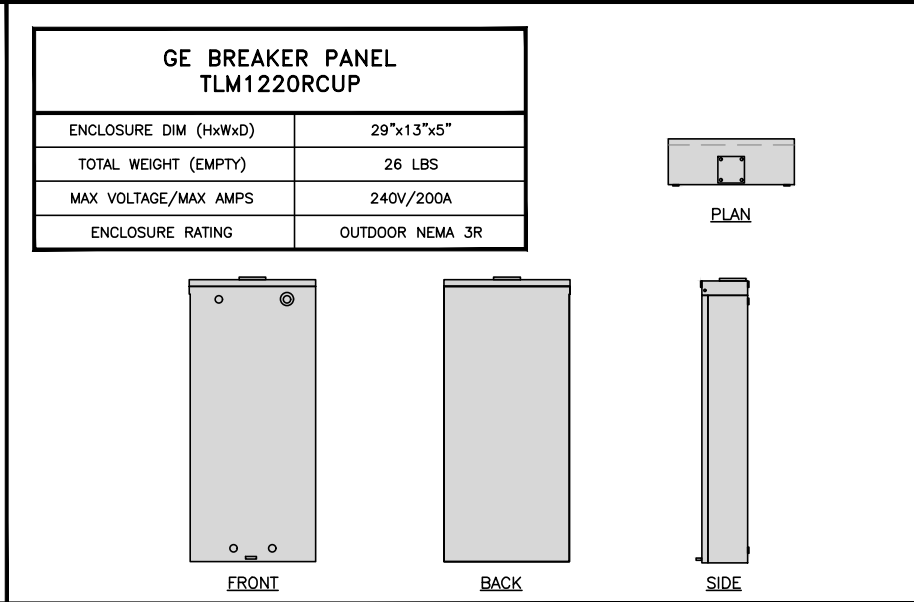
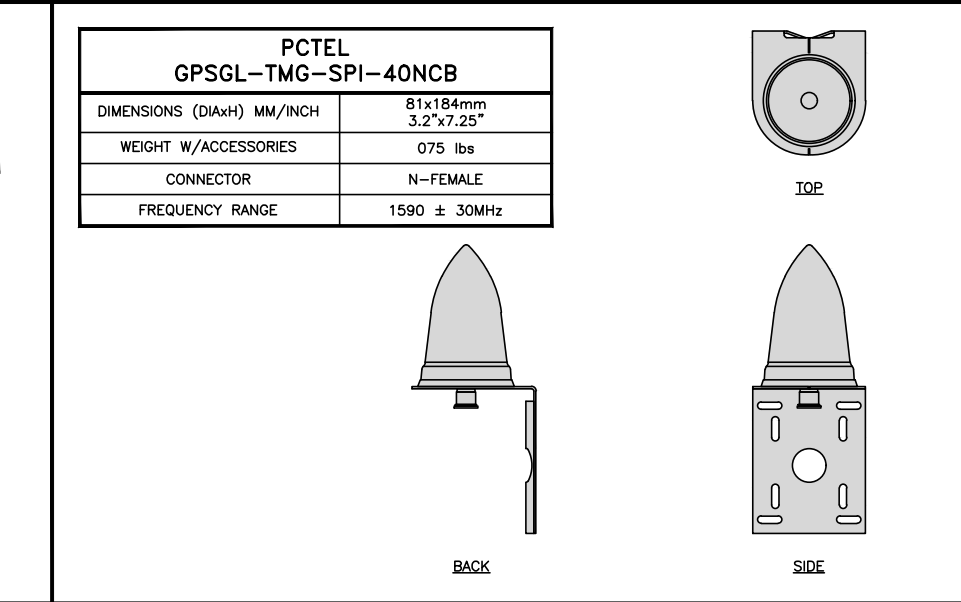
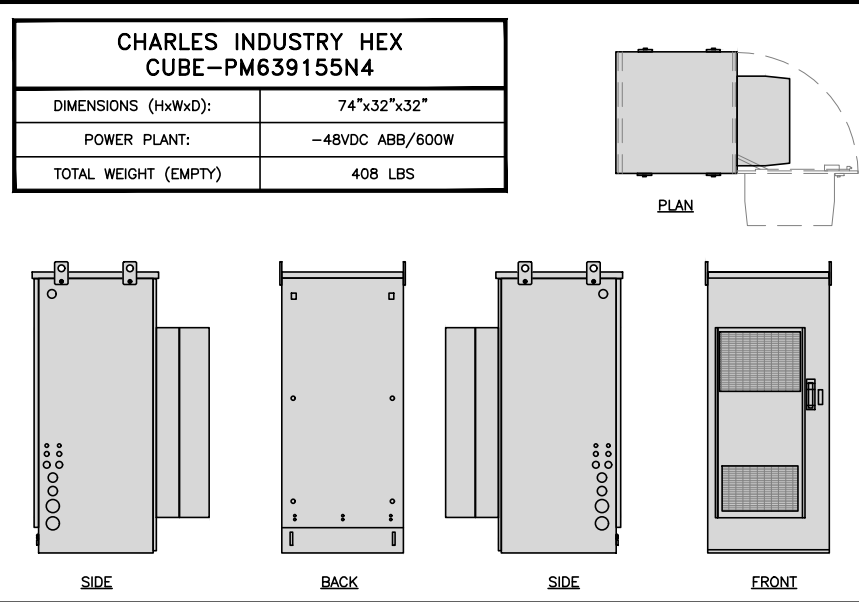

**CABINET DETAIL** NO SCALE 1

**GPS DETAIL** NO SCALE 2

**BREAKER PANEL DETAIL** NO SCALE 3

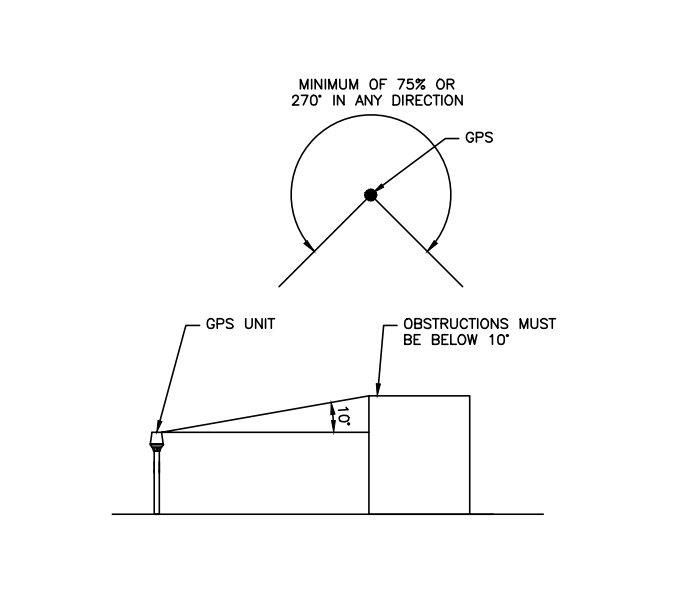
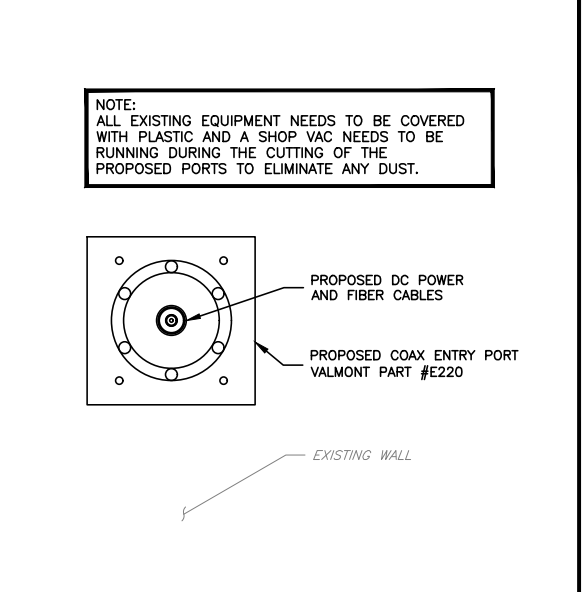
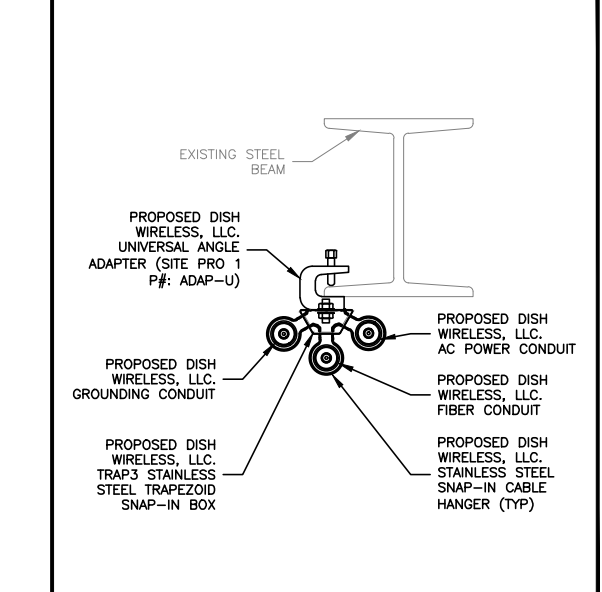
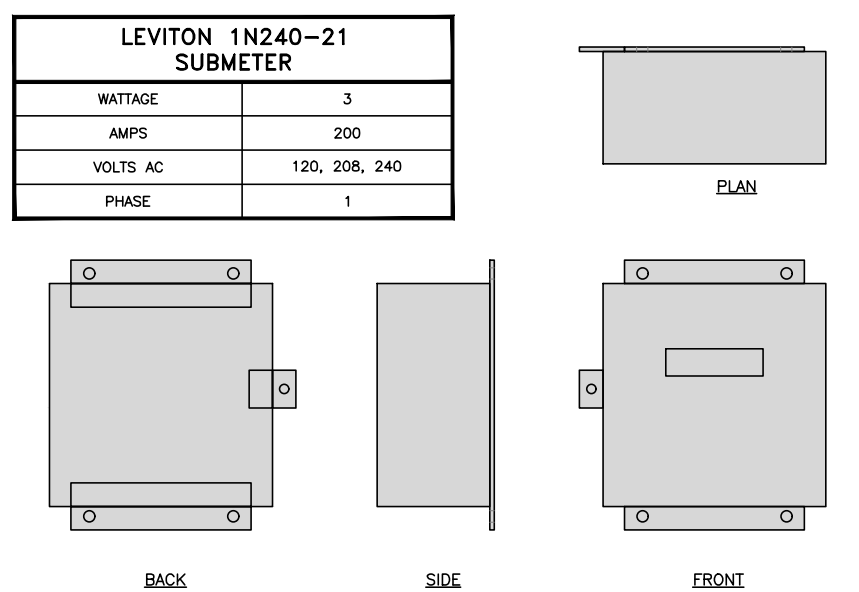

**E-MON D-MON DETAIL** NO SCALE 4

**CABLE MOUNTING DETAIL** NO SCALE 5

**CABLE PORT DETAIL** NO SCALE 6

**GPS MINIMUM SKY VIEW REQUIREMENTS** NO SCALE 7

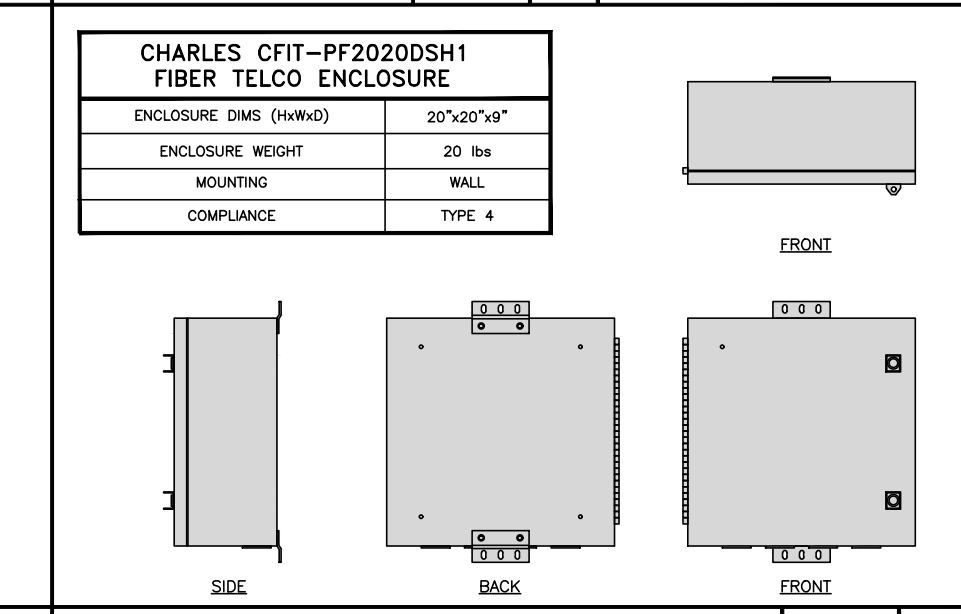
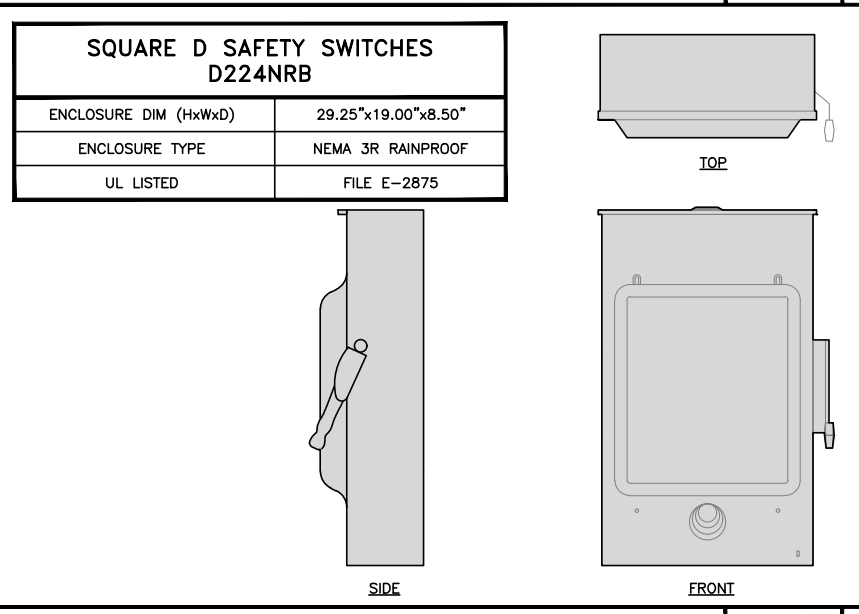

**SAFETY SWITCH DETAIL** NO SCALE 8

**FIBER TELCO ENCLOSURE DETAIL** NO SCALE 9

**NOT USED** NO SCALE 10

5701 SOUTH SANTA FE DRIVE  
LITTLETON, CO 80120

**TOTALLY COMMITTED.**  
NB+C ENGINEERING SERVICES, LLC.  
100 APOLLO DRIVE  
SUITE 303  
CHELMSFORD, MA 01824  
(978) 856-8308

IT IS A VIOLATION OF LAW FOR ANY PERSON, UNLESS THEY ARE ACTING UNDER THE DIRECTION OF A LICENSED PROFESSIONAL ENGINEER, TO ALTER THIS DOCUMENT.

DRAWN BY: CWK CHECKED BY: NSB APPROVED BY: DRG

RFDS REV #: 1

**CONSTRUCTION DOCUMENTS**

SUBMITTALS		
REV	DATE	DESCRIPTION
0	01/20/22	ISSUED FOR CONSTRUCTION
1	06/27/23	UTILITY ROUTES REVISED

A&E PROJECT NUMBER  
**100753**

DISH WIRELESS, LLC.  
PROJECT INFORMATION  
**BOBOS00343A**  
1815 MASSACHUSETTS AVE.  
CAMBRIDGE, MA 02140

SHEET TITLE  
**EQUIPMENT DETAILS**

SHEET NUMBER  
**A-5**

SAMSUNG – MID BAND SFG-ARR3KM01DI_RF4451D-70A	
DIMENSIONS (HxWxD)	15"x15"x8.9"
WEIGHT	61.3 lbs
CONNECTOR TYPE	4.3-10 RF CONNECTOR -48VDC
INPUT VOLTAGE	(-36 to 58 VDC)

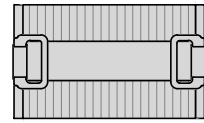

PLAN

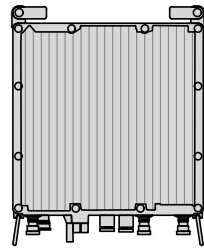

BACK

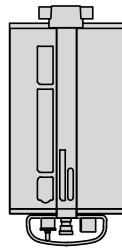

SIDE

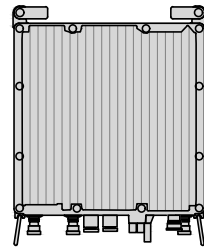

FRONT

RRH DETAIL

NO SCALE

1

SAMSUNG – LOW BAND SFG-ARR3J601DI_RF4450T-71A	
DIMENSIONS (HxWxD)	15"x16.5"x11"
WEIGHT	94.6 lbs
CONNECTOR TYPE	4.3-10 RF CONNECTOR -48VDC
INPUT VOLTAGE	(-36 to 58 VDC)

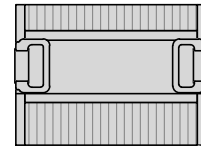

PLAN

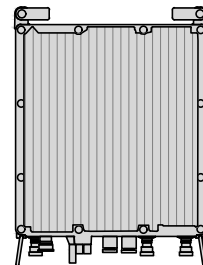

BACK

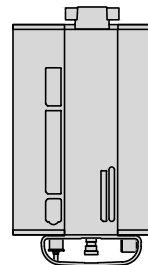

SIDE

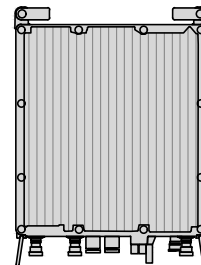

FRONT

RRH DETAIL

NO SCALE

2

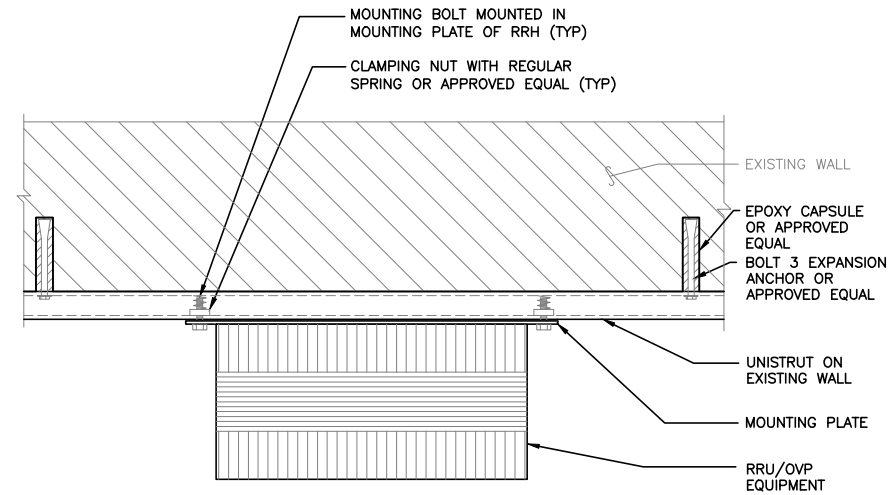

RRH/OVP UNISTRUT WALL MOUNT DETAIL

NO SCALE

3

RAYCAP RDIDC-3045-PF-48 SURGE PROTECTION DEVICE (OVP)	
DIMENSIONS (HxWxD)	18.97"x16.21"x9.64"
WEIGHT	21 lbs

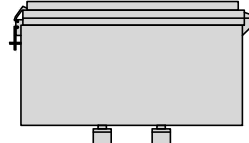

PLAN

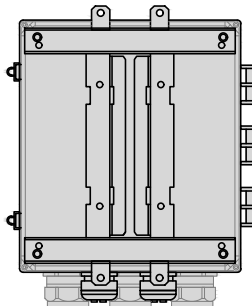

BACK

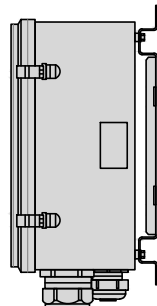

SIDE

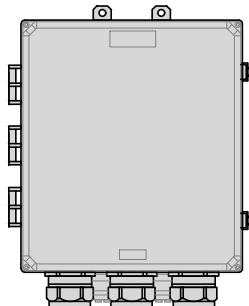

FRONT

SURGE PROTECTION DEVICE DETAIL (OVP)

NO SCALE

4

JMA MX08FRO665-21	
DIMENSIONS (HxWxD)	72.8"x20.0"x8.0"
RF PORTS, CONNECTOR TYPE	8 x 4.3-10 FEMALE
WEIGHT	64.5 lbs
WEIGHT WITH BRACKETS	82.5 lbs

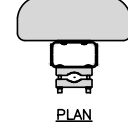

PLAN

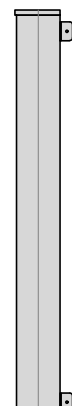

SIDE

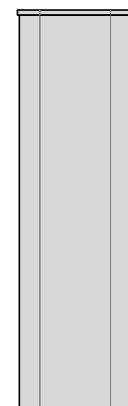

FRONT

ANTENNA DETAIL

NO SCALE

5

COMMSCOPE RT-CB4D ROOFTOP COVER KIT		MOUNTING	NON-PENETRATING
DIMENSIONS (HxWxL)	7"x 11.25"x 96"	INCLUDED PRODUCTS:	RTCB4D.01 CHANNEL (1) MT-F1598 SLEEPERS (3) RTCUH HARDWARE RTHC.01 HOLD-DOWN CLAMPS (6)
WEIGHT/ VOLUME	85.98 LBS		
CABLE RUN (QTY)	4		

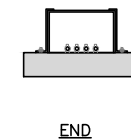

END

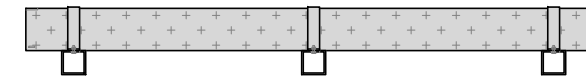

SIDE

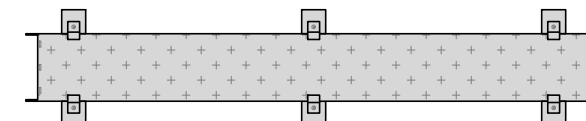

PLAN

ROOFTOP CABLE TRAY DETAIL

NO SCALE

6

JMA ANTENNA MOUNTING BRACKET #91900318	
TOTAL WEIGHT (WITH BRACKETS)	18 lbs (8.18 Kg)
POLE DIAMETER RANGE	2.5 TO 4.5 INCHES

NOTE:  
KIT #91900318: TOP AND BOTTOM BRACKETS FOR 4-, 6-, AND 8-FOOT ANTENNAS  
ANTENNA BRACKET NOT PART OF KIT

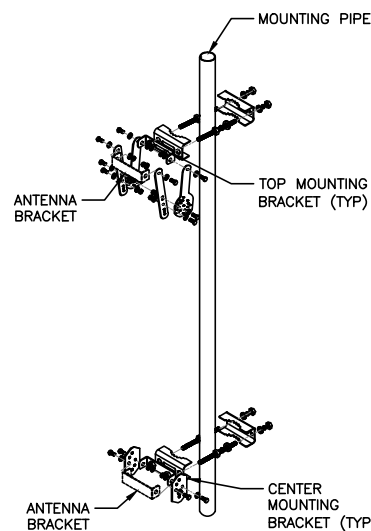

ANTENNA BRACKET DETAIL

NO SCALE

7

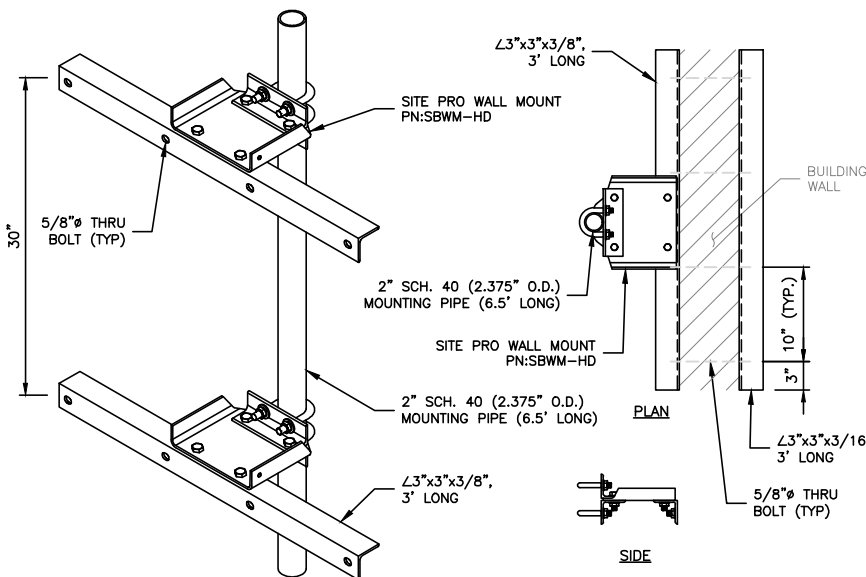

ANTENNA MOUNT DETAIL

NO SCALE

8

NOT USED

NO SCALE

9

**dish**  
wireless.

5701 SOUTH SANTA FE DRIVE  
LITTLETON, CO 80120

**NB+C**  
TOTALLY COMMITTED.

NB+C ENGINEERING SERVICES, LLC.

100 APOLLO DRIVE  
SUITE 303  
CHELMSFORD, MA 01824  
(978) 856-8308



IT IS A VIOLATION OF LAW FOR ANY PERSON, UNLESS THEY ARE ACTING UNDER THE DIRECTION OF A LICENSED PROFESSIONAL ENGINEER, TO ALTER THIS DOCUMENT.

DRAWN BY: CHECKED BY: APPROVED BY:  
CWE NSB DRG

RFDS REV #: 1

CONSTRUCTION DOCUMENTS

SUBMITTALS		
REV	DATE	DESCRIPTION
0	01/20/22	ISSUED FOR CONSTRUCTION
1	06/27/23	UTILITY ROUTES REVISED

A&E PROJECT NUMBER  
100753

DISH WIRELESS, LLC.  
PROJECT INFORMATION  
BOBOS00343A

1815 MASSACHUSETTS AVE.  
CAMBRIDGE, MA 02140

SHEET TITLE  
EQUIPMENT DETAILS

SHEET NUMBER

**A-6**

**NOTE**

CONTRACTOR SHALL FIELD VERIFY ALL DIMENSIONS.

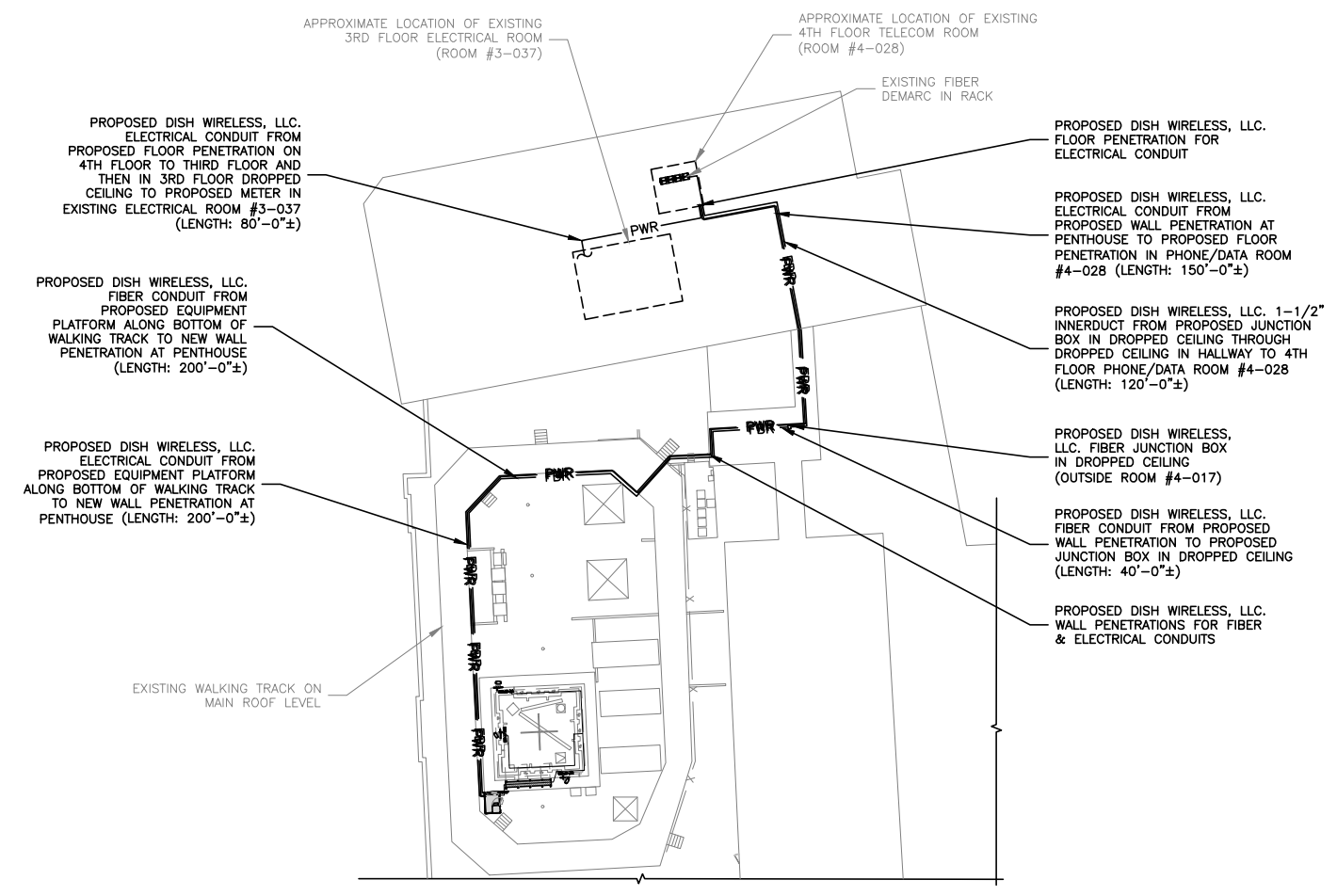

**UTILITY ROUTE PLAN**

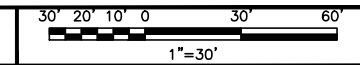

1

**NOTES**

1. CONTRACTOR SHALL FIELD VERIFY ALL DIMENSIONS.

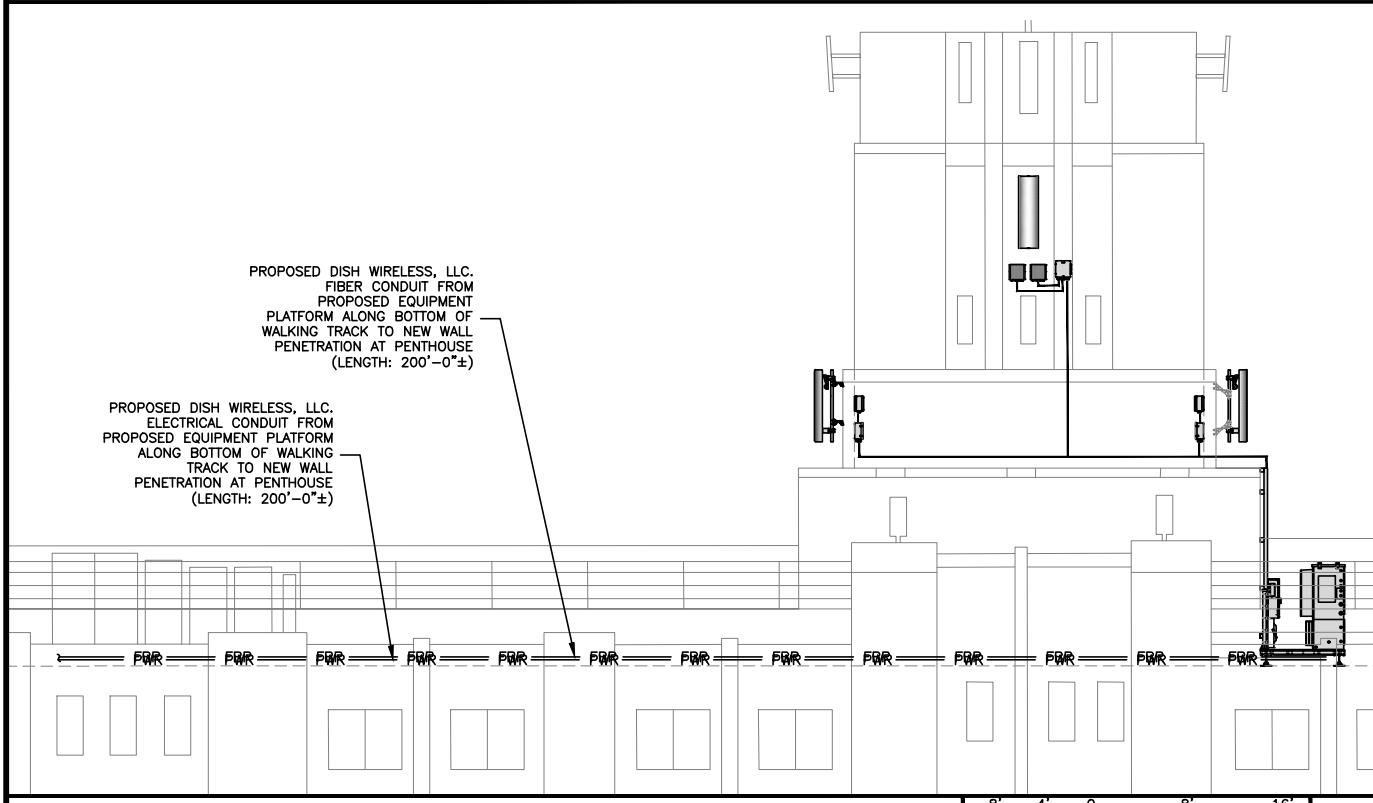

**UTILITY ROUTE ELEVATION**

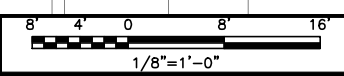

3

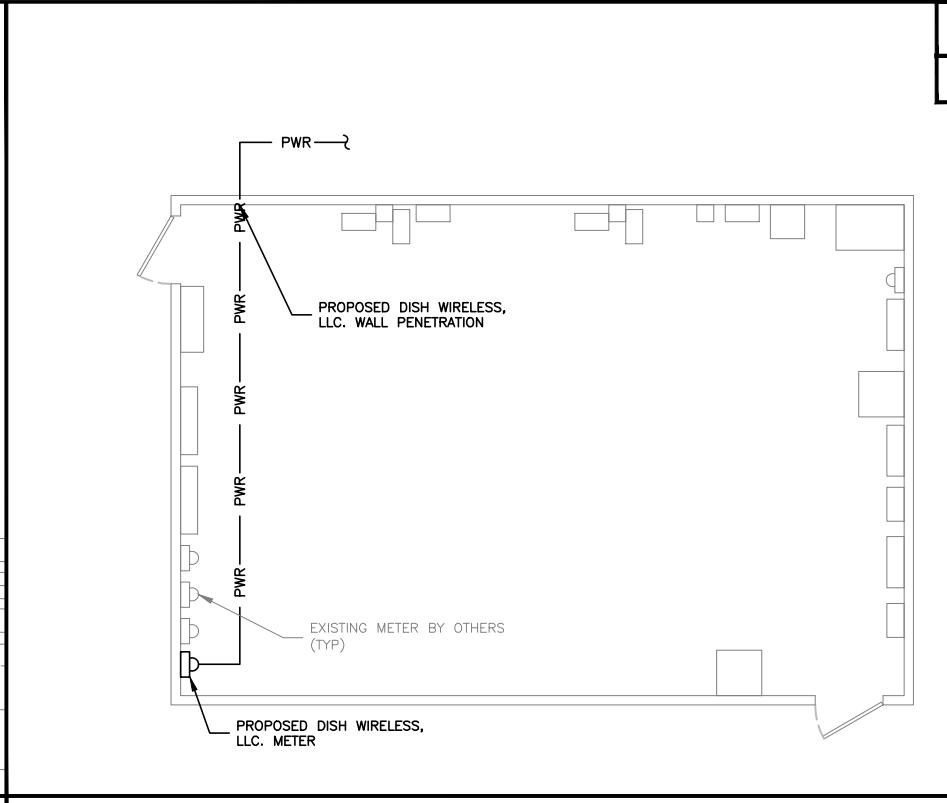

**ELECTRICAL ROOM PLAN (3RD FLOOR)**

NO SCALE

4



5701 SOUTH SANTA FE DRIVE  
LITTLETON, CO 80120



**NB+C ENGINEERING SERVICES, LLC.**  
100 APOLLO DRIVE  
SUITE 303  
CHELMSFORD, MA 01824  
(978) 856-8308



IT IS A VIOLATION OF LAW FOR ANY PERSON, UNLESS THEY ARE ACTING UNDER THE DIRECTION OF A LICENSED PROFESSIONAL ENGINEER, TO ALTER THIS DOCUMENT.

DRAWN BY: CHECKED BY: APPROVED BY:  
CWE NSB DRG

RFDS REV #: 1

**CONSTRUCTION DOCUMENTS**

SUBMITTALS		
REV	DATE	DESCRIPTION
0	01/20/22	ISSUED FOR CONSTRUCTION
1	06/27/23	UTILITY ROUTES REVISED

A&E PROJECT NUMBER  
**100753**

DISH WIRELESS, LLC.  
PROJECT INFORMATION  
**BOBOS00343A**

1815 MASSACHUSETTS AVE.  
CAMBRIDGE, MA 02140

SHEET TITLE  
**ELECTRICAL/FIBER ROUTE PLAN AND NOTES**

SHEET NUMBER  
**E-1**



DC POWER WIRING SHALL BE COLOR CODED AT EACH END FOR IDENTIFYING +24V AND -48V CONDUCTORS. RED MARKINGS SHALL IDENTIFY +24V AND BLUE MARKINGS SHALL IDENTIFY -48V.

- CONTRACTOR SHALL INSPECT THE EXISTING CONDITIONS PRIOR TO SUBMITTING A BID. ANY QUESTIONS ARISING DURING THE BID PERIOD IN REGARDS TO THE CONTRACTOR'S FUNCTIONS, THE SCOPE OF WORK, OR ANY OTHER ISSUE RELATED TO THIS PROJECT SHALL BE BROUGHT UP DURING THE BID PERIOD WITH THE PROJECT MANAGER FOR CLARIFICATION, NOT AFTER THE CONTRACT HAS BEEN AWARDED.
- ALL ELECTRICAL WORK SHALL BE DONE IN ACCORDANCE WITH CURRENT NATIONAL ELECTRICAL CODES AND ALL STATE AND LOCAL CODES, LAWS, AND ORDINANCES. PROVIDE ALL COMPONENTS AND WIRING SIZES AS REQUIRED TO MEET NEC STANDARDS.
- LOCATION OF EQUIPMENT, CONDUIT AND DEVICES SHOWN ON THE DRAWINGS ARE APPROXIMATE AND SHALL BE COORDINATED WITH FIELD CONDITIONS PRIOR TO CONSTRUCTION.
- CONDUIT ROUGH-IN SHALL BE COORDINATED WITH THE MECHANICAL EQUIPMENT TO AVOID LOCATION CONFLICTS. VERIFY WITH THE MECHANICAL EQUIPMENT CONTRACTOR AND COMPLY AS REQUIRED.
- CONTRACTOR SHALL PROVIDE ALL BREAKERS, CONDUITS AND CIRCUITS AS REQUIRED FOR A COMPLETE SYSTEM.
- CONTRACTOR SHALL PROVIDE PULL BOXES AND JUNCTION BOXES AS REQUIRED BY THE NEC ARTICLE 314.
- CONTRACTOR SHALL PROVIDE ALL STRAIN RELIEF AND CABLE SUPPORTS FOR ALL CABLE ASSEMBLIES. INSTALLATION SHALL BE IN ACCORDANCE WITH MANUFACTURER'S SPECIFICATIONS AND RECOMMENDATIONS.
- ALL DISCONNECTS AND CONTROLLING DEVICES SHALL BE PROVIDED WITH ENGRAVED PHENOLIC NAMEPLATES INDICATING EQUIPMENT CONTROLLED, BRANCH CIRCUITS INSTALLED ON, AND PANEL FIELD LOCATIONS FED FROM.
- INSTALL AN EQUIPMENT GROUNDING CONDUCTOR IN ALL CONDUITS PER THE SPECIFICATIONS AND NEC 250. THE EQUIPMENT GROUNDING CONDUCTORS SHALL BE BONDED AT ALL JUNCTION BOXES, PULL BOXES, AND ALL DISCONNECT SWITCHES, AND EQUIPMENT CABINETS.
- ALL NEW MATERIAL SHALL HAVE A U.L. LABEL.
- PANEL SCHEDULE LOADING AND CIRCUIT ARRANGEMENTS REFLECT POST-CONSTRUCTION EQUIPMENT.
- CONTRACTOR SHALL BE RESPONSIBLE FOR AS-BUILT PANEL SCHEDULE AND SITE DRAWINGS.

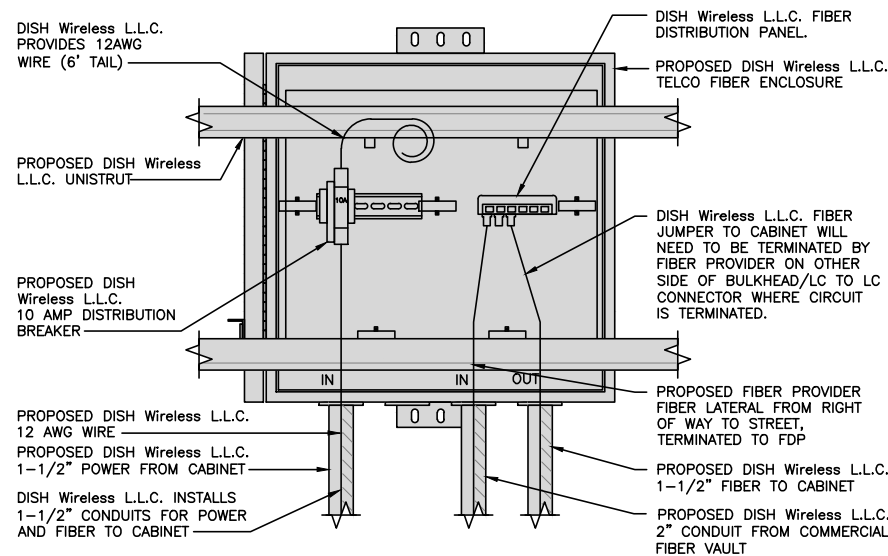

**DARK TELCO BOX - INTERIOR WIRING LAYOUT**

NO SCALE 2

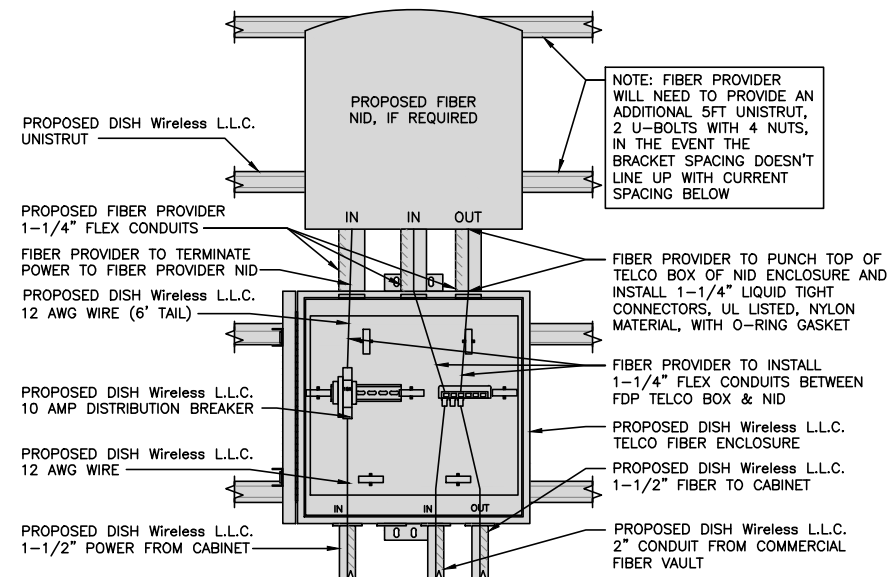

**LIT TELCO BOX - INTERIOR WIRING LAYOUT (OPTIONAL)**

NO SCALE 3

**ELECTRICAL NOTES**

NO SCALE 1

**NOT USED**

NO SCALE 4

**NOT USED**

NO SCALE 5

**NOT USED**

NO SCALE 6

**NOT USED**

NO SCALE 7

**NOT USED**

NO SCALE 8



5701 SOUTH SANTA FE DRIVE  
LITTLETON, CO 80120



**NB+C ENGINEERING SERVICES, LLC.**

100 APOLLO DRIVE  
SUITE 303  
CHELMSFORD, MA 01824  
(978) 856-8308



IT IS A VIOLATION OF LAW FOR ANY PERSON, UNLESS THEY ARE ACTING UNDER THE DIRECTION OF A LICENSED PROFESSIONAL ENGINEER, TO ALTER THIS DOCUMENT.

DRAWN BY: CWE CHECKED BY: NSB APPROVED BY: DRG

RFDS REV #: 1

**CONSTRUCTION DOCUMENTS**

SUBMITTALS		
REV	DATE	DESCRIPTION
0	01/20/22	ISSUED FOR CONSTRUCTION
1	06/27/23	UTILITY ROUTES REVISED

A&E PROJECT NUMBER  
100753

DISH WIRELESS, LLC.  
PROJECT INFORMATION  
BOBOS00343A

1815 MASSACHUSETTS AVE.  
CAMBRIDGE, MA 02140

SHEET TITLE  
ELECTRICAL  
DETAILS

SHEET NUMBER  
**E-2**

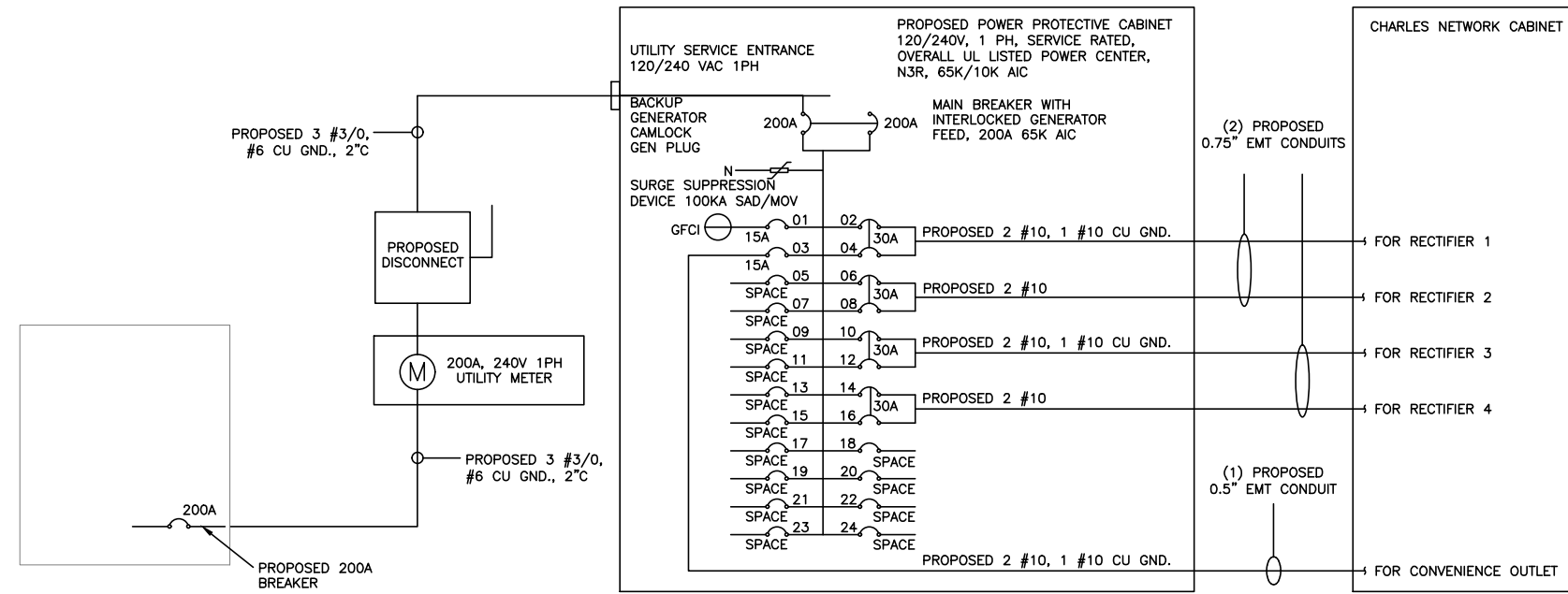

**NOTES**

THERE ARE A TOTAL OF (6) CURRENT CARRYING CONDUCTORS IN A SINGLE CONDUIT. ADJUSTABLE FACTOR OF 80% PER NEC TABLE 310.15(B)(3)(a) SHALL APPLY.

#10 FOR 15A/1P BREAKER: 0.8 x 40A = 32.0A  
#8 FOR 35A-40A/2P BREAKER: 0.8 x 55A = 44.0A

CONDUIT SIZING: ASSUME 1.5" EMT AT 40% FILL PER NEC 358, TABLE 4 - 0.814A SQ. IN AREA

WIRES: USING THWN-2, CU. (INCLUDING 3 GROUND WIRES)

#4 - 0.0824 SQ. IN X 4 = 0.3296 SQ. IN  
#8 - 0.0366 SQ. IN X 2 = 0.0732 SQ. IN  
#10 - 0.0211 SQ. IN X 2 = 0.0422 SQ. IN <GROUND  
#12 - 0.0133 SQ. IN X 1 = 0.0133 SQ. IN <GROUND

TOTAL = 0.4583 SQ. IN

1.5" EMT CONDUIT IS ADEQUATE TO HANDLE THE TOTAL OR (8) WIRES, INCLUDING GROUND WIRE, AS INDICATED ABOVE.

CONDUIT SIZING: ASSUME 2.0" EMT AT 40% FILL PER NEC 352, TABLE 4 - 1.216A SQ. IN AREA

WIRES: USING THHN, CU. (INCLUDING 2 GROUND WIRES)

#3/0 - 0.1318 SQ. IN X 3 = 0.3954 SQ. IN  
#2 - 0.0521 SQ. IN X 1 = 0.0521 SQ. IN

TOTAL = 0.4475 SQ. IN

2.0" EMT CONDUIT IS ADEQUATE TO HANDLE THE TOTAL OR (3) WIRES, INCLUDING GROUND WIRE, AS INDICATED ABOVE.



5701 SOUTH SANTA FE DRIVE  
LITTLETON, CO 80120



NB+C ENGINEERING SERVICES, LLC.

100 APOLLO DRIVE  
SUITE 303  
CHELMSFORD, MA 01824  
(978) 856-8308

(CHARLES ALPHA CORDEX DC PLANT) WITH STAND ALONE METER 120V240V 1PH SOURCE

NO SCALE 1

**PROPOSED CHARLES PANEL SCHEDULE**

LOAD SERVED	VOLT AMPS (WATTS)		TRIP	CKT #	PHASE	CKT #	TRIP	VOLT AMPS (WATTS)		LOAD SERVED
	L1	L2						L1	L2	
PPC GFCI OUTLET	180	180	15A	1	A	2	30A	2880	2880	ABB/GE INFINITY RECTIFIER 1
CHARLES GFCI OUTLET			15A	3	B	4				ABB/GE INFINITY RECTIFIER 1
-SPACE-				5	A	6	30A	2880	2880	ABB/GE INFINITY RECTIFIER 2
-SPACE-				7	B	8				ABB/GE INFINITY RECTIFIER 2
-SPACE-				9	A	10	30A	2880	2880	ABB/GE INFINITY RECTIFIER 3
-SPACE-				11	B	12				ABB/GE INFINITY RECTIFIER 3
-SPACE-				13	A	14	30A	2880	2880	ABB/GE INFINITY RECTIFIER 4
-SPACE-				15	B	16				ABB/GE INFINITY RECTIFIER 4
-SPACE-				17	A	18				-SPACE-
-SPACE-				19	B	20				-SPACE-
-SPACE-				21	A	22				-SPACE-
-SPACE-				23	B	24				-SPACE-
VOLTAGE AMPS	180	180						11520	11520	
200A MCB, 1φ, 24 SPACE, 120/240V				L1	L2					
MB RATING: 65,000 AIC				11700	11700			VOLTAGE AMPS		
				98	98			AMPS		
				98				MAX AMPS		
				123				MAX 125%		

PANEL SCHEDULE

(CHARLES ALPHA CORDEX DC PLANT) WITH STAND ALONE METER 120V240V 1PH SOURCE

NO SCALE 2

NOT USED

NO SCALE 3

NOT USED

NO SCALE 4



IT IS A VIOLATION OF LAW FOR ANY PERSON, UNLESS THEY ARE ACTING UNDER THE DIRECTION OF A LICENSED PROFESSIONAL ENGINEER, TO ALTER THIS DOCUMENT.

DRAWN BY: CWB CHECKED BY: NSB APPROVED BY: DRG

RFDS REV #: 1

**CONSTRUCTION DOCUMENTS**

SUBMITTALS

REV	DATE	DESCRIPTION
0	01/20/22	ISSUED FOR CONSTRUCTION
1	06/27/23	UTILITY ROUTES REVISED

A&E PROJECT NUMBER  
100753

DISH WIRELESS, LLC.  
PROJECT INFORMATION  
BOBOS00343A

1815 MASSACHUSETTS AVE.  
CAMBRIDGE, MA 02140

SHEET TITLE  
ELECTRICAL ONE-LINE, FAULT  
CALCS & PANEL SCHEDULE

SHEET NUMBER  
**E-3**



5701 SOUTH SANTA FE DRIVE  
LITTLETON, CO 80120



NB+C ENGINEERING SERVICES, LLC.

100 APOLLO DRIVE  
SUITE 303  
CHELMSFORD, MA 01824  
(978) 856-8308



IT IS A VIOLATION OF LAW FOR ANY PERSON, UNLESS THEY ARE ACTING UNDER THE DIRECTION OF A LICENSED PROFESSIONAL ENGINEER, TO ALTER THIS DOCUMENT.

DRAWN BY:	CHECKED BY:	APPROVED BY:
CWE	NSB	DRG

RFDS REV #: 1

**CONSTRUCTION DOCUMENTS**

SUBMITTALS		
REV	DATE	DESCRIPTION
0	01/20/22	ISSUED FOR CONSTRUCTION
1	06/27/23	UTILITY ROUTES REVISED

A&E PROJECT NUMBER  
100753

DISH WIRELESS, LLC.  
PROJECT INFORMATION  
BOBOS00343A

1815 MASSACHUSETTS AVE.  
CAMBRIDGE, MA 02140

SHEET TITLE  
GROUNDING PLANS  
AND NOTES

SHEET NUMBER

**G-1**

- EXOTHERMIC CONNECTION
- MECHANICAL CONNECTION
- ▬ GROUND BUS BAR
- GROUND ROD
- TEST GROUND ROD WITH INSPECTION SLEEVE
- #6 AWG STRANDED & INSULATED
- · - · - #2 AWG SOLID COPPER TINNED
- ▲ BUSS BAR INSULATOR

**GROUNDING LEGEND**

- GROUNDING IS SHOWN DIAGRAMMATICALLY ONLY.
- CONTRACTOR SHALL GROUND ALL EQUIPMENT AS A COMPLETE SYSTEM. GROUNDING SHALL BE IN COMPLIANCE WITH NEC SECTION 250 AND DISH WIRELESS, LLC. GROUNDING AND BONDING REQUIREMENTS AND MANUFACTURER'S SPECIFICATIONS.
- ALL GROUND CONDUCTORS SHALL BE COPPER; NO ALUMINUM CONDUCTORS SHALL BE USED.
- NO EXOTHERMIC WELDING ON ROOFTOP

**GROUNDING ROOFTOP KEY NOTES**

- EXTERIOR GROUND RING:** #2 AWG SOLID COPPER, BURIED AT A DEPTH OF AT LEAST 30 INCHES BELOW GRADE, OR 6 INCHES BELOW THE FROST LINE AND APPROXIMATELY 24 INCHES FROM THE EXTERIOR WALL OR FOOTING.
- ROOFTOP GROUND SYSTEM:** THE GROUND SYSTEM USING MINIMUM #2 AWG SOLID COPPER CONDUCTORS.
- INTERIOR GROUND RING:** #2 AWG STRANDED GREEN INSULATED COPPER CONDUCTOR EXTENDED AROUND THE PERIMETER OF THE EQUIPMENT AREA. ALL NON-TELECOMMUNICATIONS RELATED METALLIC OBJECTS FOUND WITHIN A SITE SHALL BE GROUNDED TO THE INTERIOR GROUND RING WITH #6 AWG STRANDED GREEN INSULATED CONDUCTOR.
- BOND TO INTERIOR GROUND RING:** #2 AWG SOLID TINNED COPPER WIRE PRIMARY BONDS SHALL BE PROVIDED AT LEAST AT FOUR POINTS ON THE INTERIOR GROUND RING, LOCATED AT THE CORNERS OF THE BUILDING OR ROOM.
- GROUND ROD:** UL LISTED COPPER CLAD STEEL. MINIMUM 1/2" DIAMETER BY EIGHT FEET LONG. GROUND RODS SHALL BE INSTALLED WITH INSPECTION SLEEVES. GROUND RODS SHALL BE DRIVEN TO THE DEPTH OF GROUND RING CONDUCTOR.
- CELL REFERENCE GROUND BAR (CRGB):** POINT OF GROUND REFERENCE FOR ALL COMMUNICATIONS EQUIPMENT FRAMES. ALL BONDS ARE MADE WITH #2 AWG UNLESS NOTED OTHERWISE STRANDED GREEN INSULATED COPPER CONDUCTORS. BOND TO COMMON BUILDING GROUND SYSTEM WITH (2) #2 SOLID TINNED COPPER CONDUCTORS.
- HATCH PLATE GROUND BAR:** BOND TO THE COMMON BUILDING GROUND SYSTEM WITH TWO #2 AWG STRANDED GREEN INSULATED COPPER CONDUCTORS. WHEN A HATCH-PLATE AND A CELL REFERENCE GROUND BAR ARE BOTH PRESENT, THE CRGB MUST BE CONNECTED TO THE HATCH-PLATE AND TO THE INTERIOR GROUND RING USING (2) TWO #2 AWG STRANDED GREEN INSULATED COPPER CONDUCTORS EACH.
- EXTERIOR CABLE ENTRY PORT GROUND BARS:** LOCATED AT THE ENTRANCE TO THE CELL SITE ROOM. BOND TO GROUND RING WITH A #2 AWG SOLID TINNED COPPER CONDUCTORS WITH MECHANICAL CONNECTIONS.
- TELCO GROUND BAR:** BOND TO BOTH CELL REFERENCE GROUND BAR OR EXTERIOR GROUND RING.
- FRAME BONDING:** THE BONDING POINT FOR TELECOM EQUIPMENT FRAMES SHALL BE THE GROUND BUS THAT IS NOT ISOLATED FROM THE EQUIPMENTS METAL FRAMEWORK.
- INTERIOR UNIT BONDS:** METAL FRAMES, CABINETS AND INDIVIDUAL METALLIC UNITS LOCATED WITH THE AREA OF THE INTERIOR GROUND RING REQUIRE A #6 AWG STRANDED GREEN INSULATED COPPER BOND TO THE INTERIOR GROUND RING.
- FENCE AND GATE GROUNDING:** METAL FENCES SHALL BE BONDED TO THE COMMON BUILDING GROUND SYSTEM WITH A #2 AWG SOLID TINNED COPPER CONDUCTOR AT AN INTERVAL NOT EXCEEDING 25 FEET. BONDS SHALL BE MADE AT EACH GATE POST AND ACROSS GATE OPENINGS.
- EXTERIOR UNIT BONDS:** METALLIC OBJECTS, EXTERNAL TO OR MOUNTED TO THE BUILDING, SHALL BE BONDED TO THE COMMON BUILDING GROUND SYSTEM. USING #2 TINNED SOLID COPPER WIRE
- ICE BRIDGE SUPPORTS:** EACH ICE BRIDGE LEG SHALL BE BONDED TO THE GROUND RING WITH #2 AWG BARE TINNED COPPER CONDUCTOR. PROVIDE EXOTHERMIC WELDS AT BOTH THE ICE BRIDGE LEG AND BURIED GROUND RING.
- DURING ALL DC POWER SYSTEM CHANGES INCLUDING DC SYSTEM CHANGE OUTS, RECTIFIER REPLACEMENTS OR ADDITIONS, BREAKER DISTRIBUTION CHANGES, BATTERY ADDITIONS, BATTERY REPLACEMENTS AND INSTALLATIONS OR CHANGES TO DC CONVERTER SYSTEMS IT SHALL BE REQUIRED THAT SERVICE CONTRACTORS VERIFY ALL DC POWER SYSTEMS ARE EQUIPPED WITH A MASTER DC SYSTEM RETURN GROUND CONDUCTOR FROM THE DC POWER SYSTEM COMMON RETURN BUS DIRECTLY CONNECTED TO THE CELL SITE REFERENCE GROUND BAR**
- ROOFTOP COLLECTOR BUSS BAR IS TO BE MECHANICALLY BONDED TO COMMON BUILDING GROUND SYSTEM. REFER TO DISH WIRELESS, LLC. GROUNDING NOTES.**

APPROXIMATE LOCATION OF EXISTING MAIN WATER SERVICE ENTRANCE IN LOWER LEVEL

PROPOSED DISH WIRELESS, LLC. GROUNDING CONDUIT FROM PROPOSED EQUIPMENT PLATFORM ALONG BOTTOM OF WALKING TRACK TO EXISTING MAIN WATER SERVICE IN LOWER LEVEL (LENGTH: 130'-0"±)



**GROUNDING PLAN**

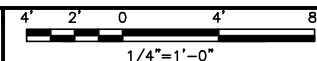

1

**GROUNDING KEY NOTES**

NO SCALE

2

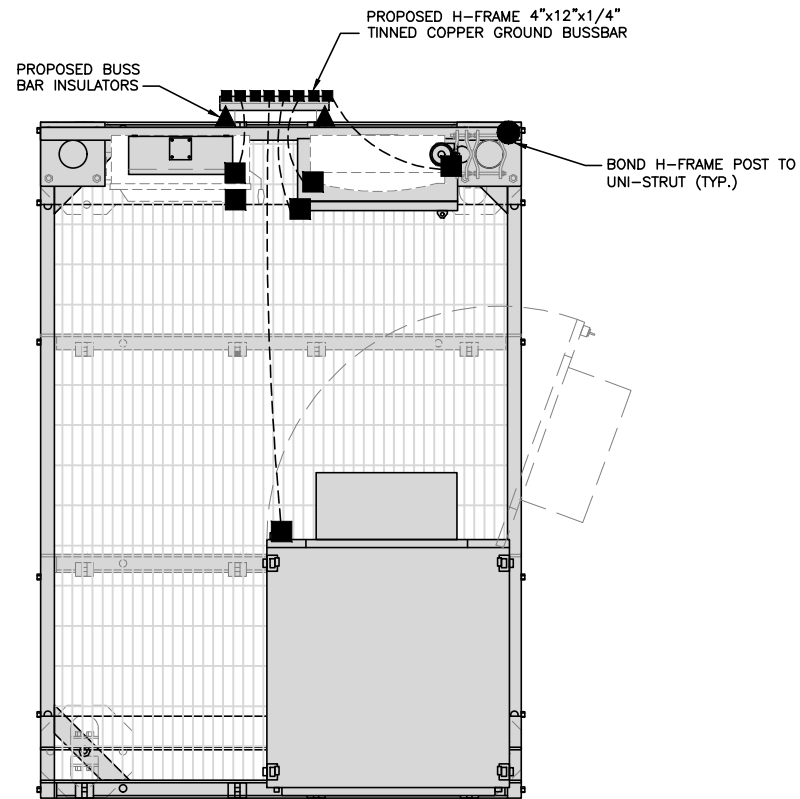

TYPICAL ROOFTOP EQUIPMENT GROUNDING PLAN

NO SCALE 1

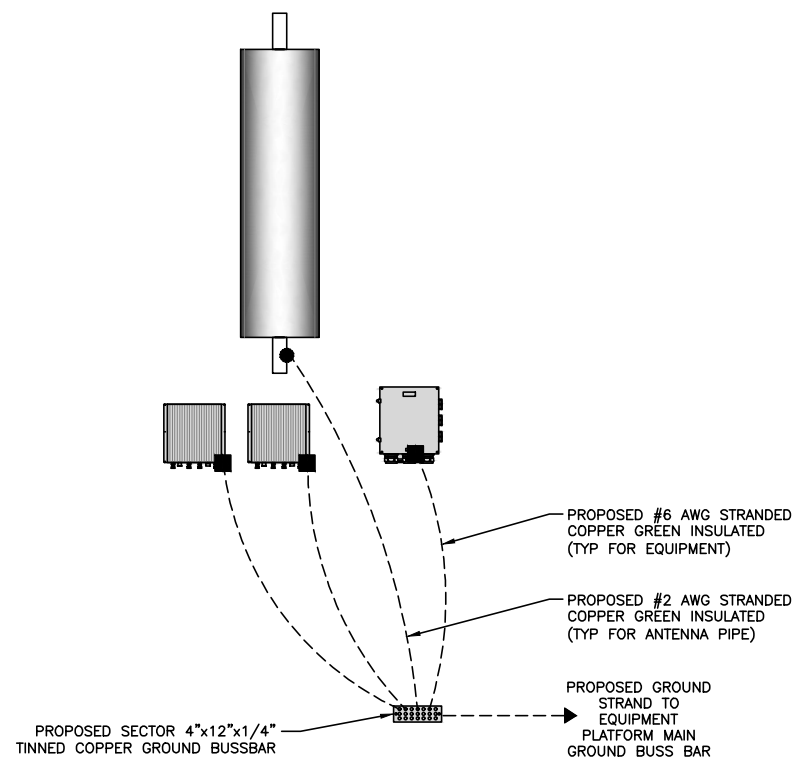

ANTENNA GROUNDING PLAN

NO SCALE 2

NOTE

EQUIPMENT CABINET OMITTED FOR CLARITY

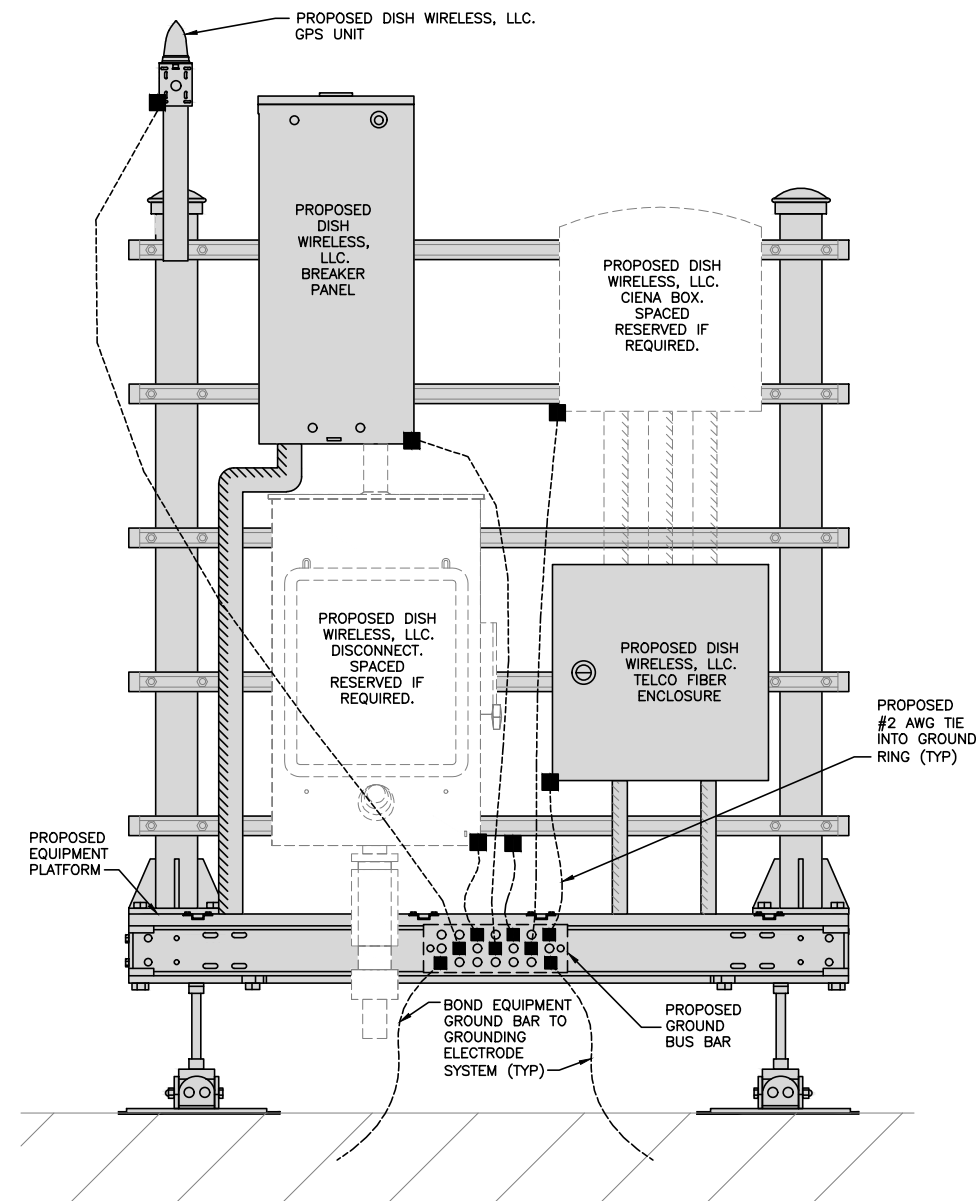

H-FRAME GROUNDING DETAIL

NO SCALE 3



5701 SOUTH SANTA FE DRIVE  
LITTLETON, CO 80120



NB+C ENGINEERING SERVICES, LLC.

100 APOLLO DRIVE  
SUITE 303  
CHELMSFORD, MA 01824  
(978) 856-8308



IT IS A VIOLATION OF LAW FOR ANY PERSON, UNLESS THEY ARE ACTING UNDER THE DIRECTION OF A LICENSED PROFESSIONAL ENGINEER, TO ALTER THIS DOCUMENT.

DRAWN BY: CHECKED BY: APPROVED BY:  
CWE NSB DRG

RFDS REV #: 1

CONSTRUCTION DOCUMENTS

SUBMITTALS		
REV	DATE	DESCRIPTION
0	01/20/22	ISSUED FOR CONSTRUCTION
1	06/27/23	UTILITY ROUTES REVISED

A&E PROJECT NUMBER  
100753

DISH WIRELESS, LLC.  
PROJECT INFORMATION  
BOBOS00343A  
1815 MASSACHUSETTS AVE.  
CAMBRIDGE, MA 02140

SHEET TITLE  
GROUNDING DETAILS

SHEET NUMBER  
G-2



1. EXOTHERMIC WELD (2) TWO, #2 AWG BARE TINNED SOLID COPPER CONDUCTORS TO GROUND BAR. ROUTE CONDUCTORS TO BURIED GROUND RING AND PROVIDE PARALLEL EXOTHERMIC WELD.
2. ALL EXTERIOR GROUNDING HARDWARE SHALL BE STAINLESS STEEL 3/8" DIAMETER OR LARGER. ALL HARDWARE 18-8 STAINLESS STEEL INCLUDING LOCK WASHERS, COAT ALL SURFACES WITH AN ANTI-OXIDANT COMPOUND BEFORE MATING.
3. FOR GROUND BOND TO STEEL ONLY: COAT ALL SURFACES WITH AN ANTI-OXIDANT COMPOUND BEFORE MATING.
4. DO NOT INSTALL CABLE GROUNDING KIT AT A BEND AND ALWAYS DIRECT GROUND CONDUCTOR DOWN TO GROUNDING BUS.
5. NUT & WASHER SHALL BE PLACED ON THE FRONT SIDE OF THE GROUND BAR AND BOLTED ON THE BACK SIDE.
6. ALL GROUNDING PARTS AND EQUIPMENT TO BE SUPPLIED AND INSTALLED BY CONTRACTOR.
7. THE CONTRACTOR SHALL BE RESPONSIBLE FOR INSTALLING ADDITIONAL GROUND BAR AS REQUIRED.
8. ENSURE THE WIRE INSULATION TERMINATION IS WITHIN 1/8" OF THE BARREL (NO SHINERS).

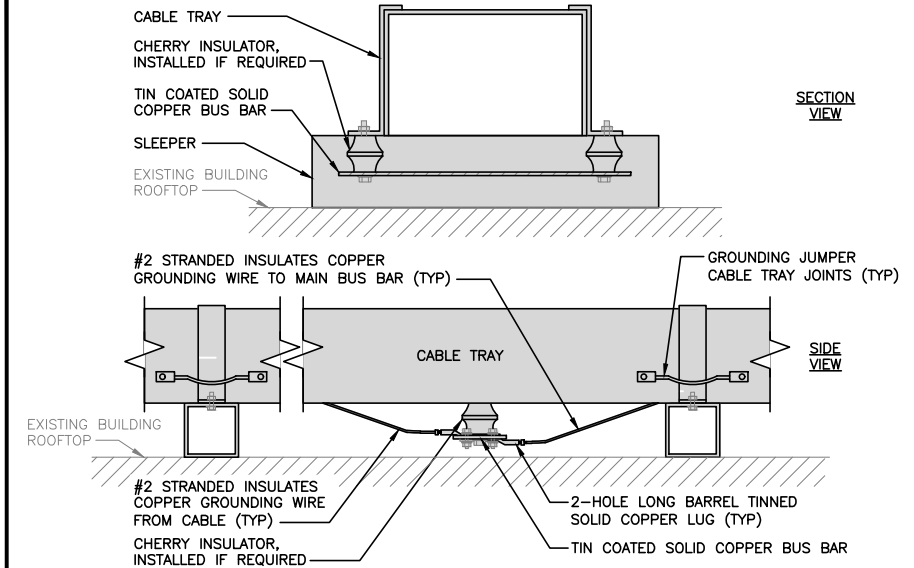
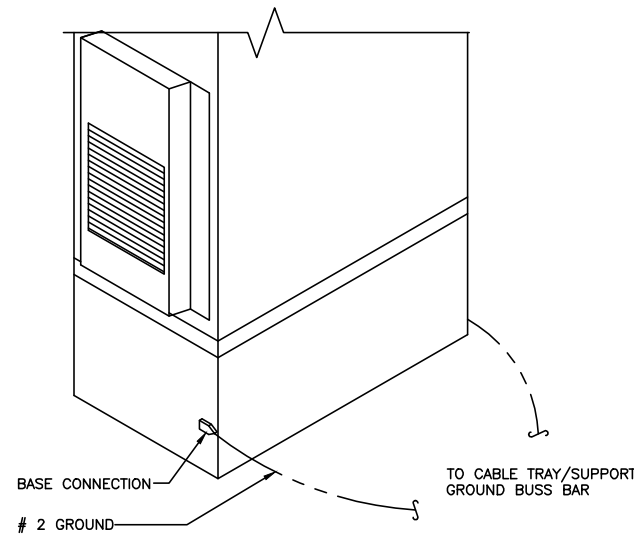

TYPICAL GROUNDING NOTES

NO SCALE 1

OUTDOOR CABINET GROUNDING

NO SCALE 2

TYPICAL CABLE TRAY GROUND BUSS BAR

NO SCALE 3

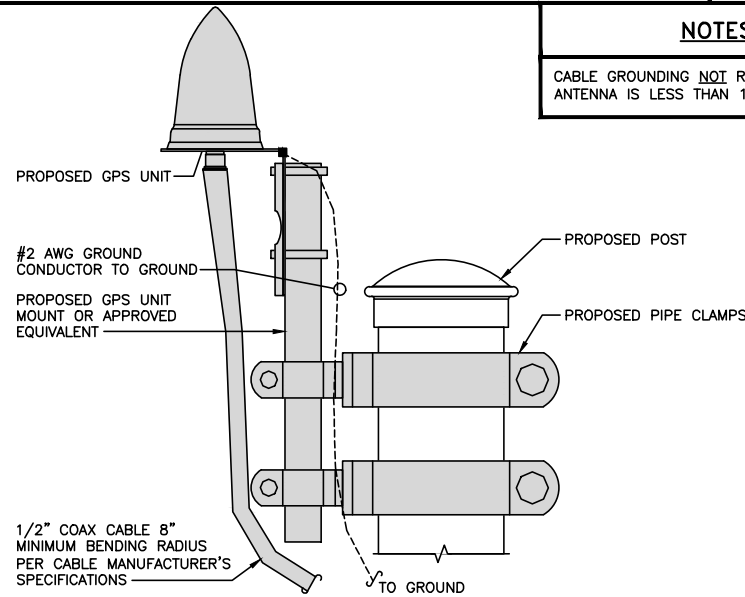

NOTES

CABLE GROUNDING NOT REQUIRED WHEN ANTENNA IS LESS THAN 10' FROM CABINET

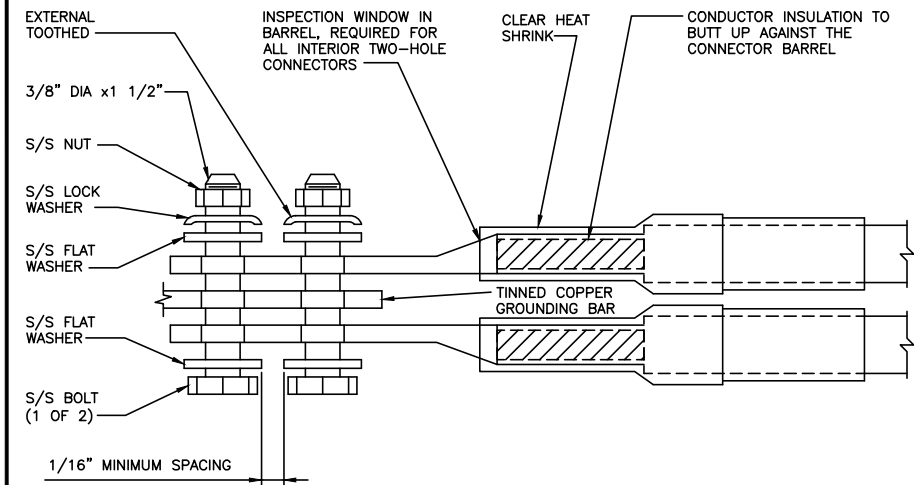
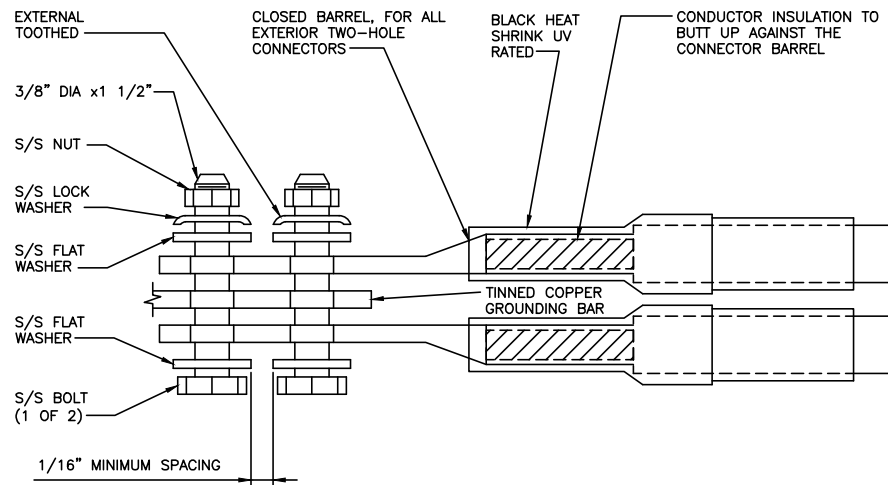

TYPICAL GPS UNIT GROUNDING

NO SCALE 4

TYPICAL EXTERIOR TWO HOLE LUG

NO SCALE 5

TYPICAL INTERIOR TWO HOLE LUG

NO SCALE 6

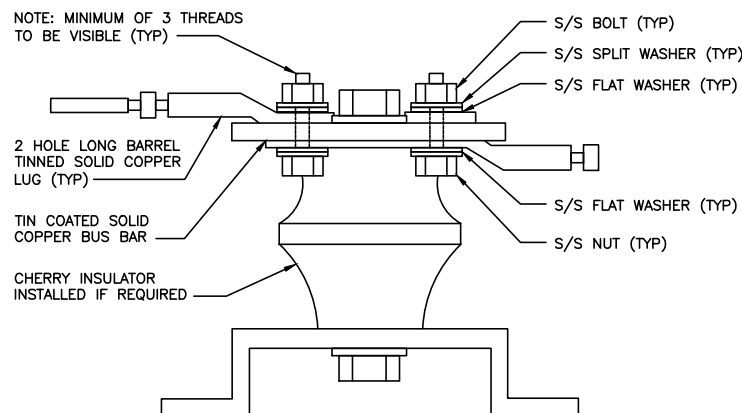

LUG DETAIL

NO SCALE 7

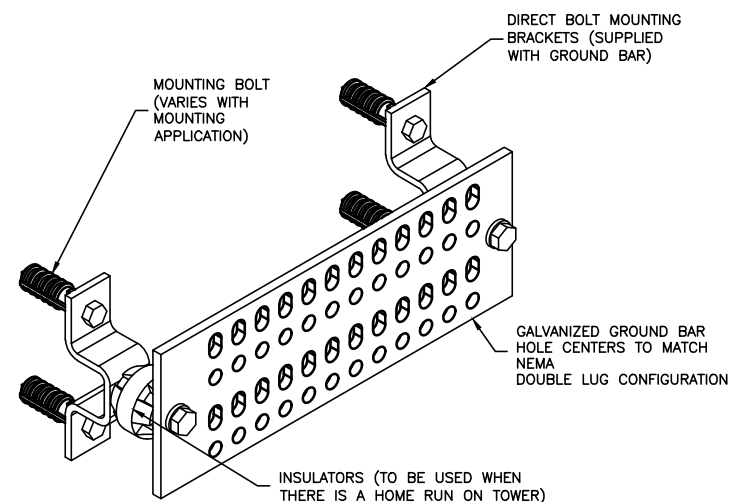

GROUND BAR DETAIL

NO SCALE 8

NOT USED

NO SCALE 9

**dish**  
wireless.

5701 SOUTH SANTA FE DRIVE  
LITTLETON, CO 80120

**NB+C**  
TOTALLY COMMITTED

NB+C ENGINEERING SERVICES, LLC.

100 APOLLO DRIVE  
SUITE 303  
CHELMSFORD, MA 01824  
(978) 856-8308



IT IS A VIOLATION OF LAW FOR ANY PERSON, UNLESS THEY ARE ACTING UNDER THE DIRECTION OF A LICENSED PROFESSIONAL ENGINEER, TO ALTER THIS DOCUMENT.

DRAWN BY: CHECKED BY: APPROVED BY:  
CWE NSB DRG

RFDS REV #: 1

CONSTRUCTION DOCUMENTS

SUBMITTALS		
REV	DATE	DESCRIPTION
0	01/20/22	ISSUED FOR CONSTRUCTION
1	06/27/23	UTILITY ROUTES REVISED

A&E PROJECT NUMBER  
100753

DISH WIRELESS, LLC.  
PROJECT INFORMATION  
BOBOS00343A

1815 MASSACHUSETTS AVE.  
CAMBRIDGE, MA 02140

SHEET TITLE  
GROUNDING DETAILS

SHEET NUMBER

**G-3**



5701 SOUTH SANTA FE DRIVE  
LITTLETON, CO 80120



NB+C ENGINEERING SERVICES, LLC.

100 APOLLO DRIVE  
SUITE 303  
CHELMSFORD, MA 01824  
(978) 856-8308



IT IS A VIOLATION OF LAW FOR ANY PERSON, UNLESS THEY ARE ACTING UNDER THE DIRECTION OF A LICENSED PROFESSIONAL ENGINEER, TO ALTER THIS DOCUMENT.

DRAWN BY: CWB CHECKED BY: NSB APPROVED BY: DRG

RFDS REV #: 1

CONSTRUCTION DOCUMENTS

SUBMITTALS		
REV	DATE	DESCRIPTION
0	01/20/22	ISSUED FOR CONSTRUCTION
1	06/27/23	UTILITY ROUTES REVISED

A&E PROJECT NUMBER  
100753

DISH WIRELESS, LLC.  
PROJECT INFORMATION  
BOBOS00343A

1815 MASSACHUSETTS AVE.  
CAMBRIDGE, MA 02140

SHEET TITLE  
RF  
CABLE COLOR CODE

SHEET NUMBER  
RF-1

LOW BANDS (N71-N28)  
OPTIONAL - (N29)  
ORANGE

AWS  
(N65+N70+H-BLOCK)  
PURPLE

CBRS TECH  
(3 GHz)  
YELLOW

NEGATIVE SLANT PORT  
ON ANTRRH  
WHITE

ALPHA SECTOR

RED

BETA SECTOR

BLUE

GAMMA SECTOR

GREEN

COLOR IDENTIFIER

NO SCALE

2

NOT USED

NO SCALE

3

NOT USED

NO SCALE

4

RF Cable Color Codes



RF Jumper Color Coding

3/4" tape widths with 3/4" spacing

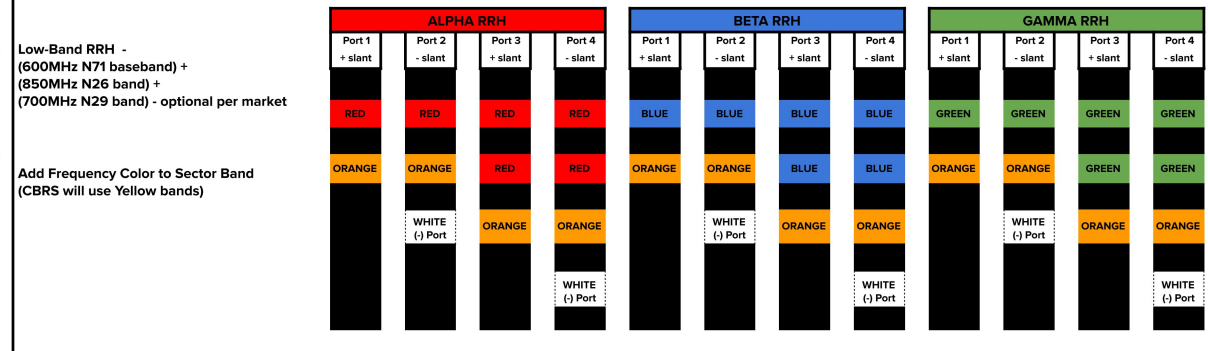

Mid-band RRH - (AWS bands N66+N70)

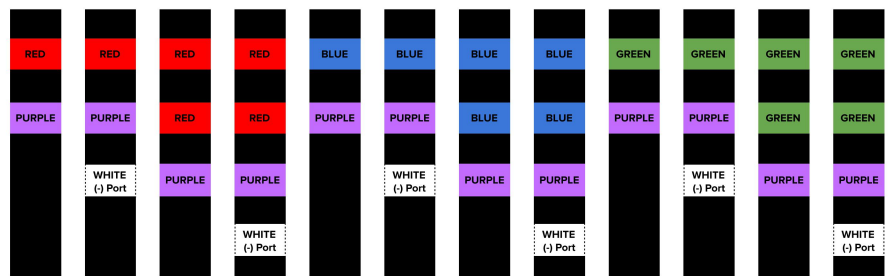

Hybrid/Discreet Cables

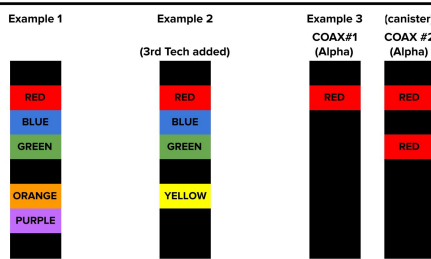

Fiber Jumpers to RRHs

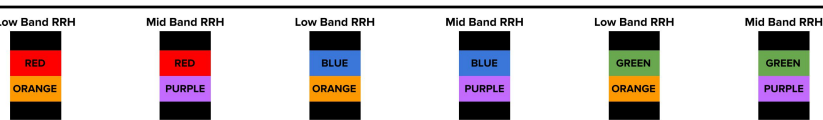

Power Cables to RRHs



RET motors at Antennas

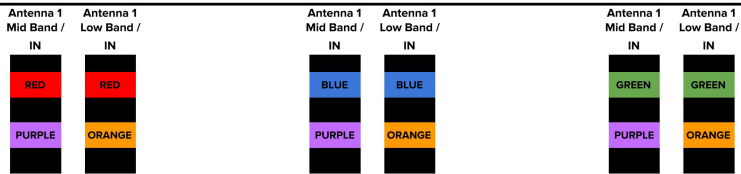

Microwave Radio Links

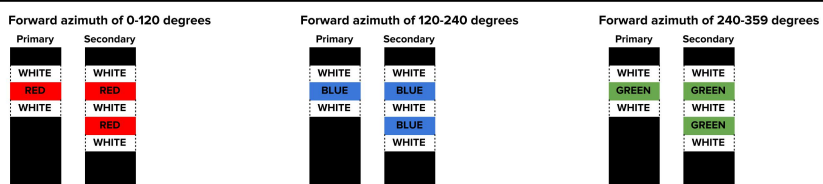

RF CABLE COLOR CODES

NO SCALE

1

NOT USED

NO SCALE

4

EXOTHERMIC CONNECTION  
 MECHANICAL CONNECTION  
 BUSS BAR INSULATOR  
 CHEMICAL ELECTROLYTIC GROUNDING SYSTEM  
 TEST CHEMICAL ELECTROLYTIC GROUNDING SYSTEM  
 EXOTHERMIC WITH INSPECTION SLEEVE  
 GROUNDING BAR  
 GROUND ROD  
 TEST GROUND ROD WITH INSPECTION SLEEVE  
 SINGLE POLE SWITCH  
 DUPLEX RECEPTACLE  
 DUPLEX GFCI RECEPTACLE  
 FLUORESCENT LIGHTING FIXTURE  
 (2) TWO LAMPS 48-T8  
 SMOKE DETECTION (DC)  
 EMERGENCY LIGHTING (DC)  
 SECURITY LIGHT W/PHOTOCELL LITHONIA ALXW  
~~CELANO L-12BA-400V3~~ K-SR4-120-PE-DBTDX  
 WOOD/WROUGHT IRON FENCE  
 WALL STRUCTURE  
 LEASE AREA  
 PROPERTY LINE (PL)  
 SETBACKS  
 ICE BRIDGE  
 CABLE TRAY  
 WATER LINE  
 UNDERGROUND POWER  
 UNDERGROUND TELCO  
 OVERHEAD POWER  
 OVERHEAD TELCO  
 UNDERGROUND TELCO/POWER  
 ABOVE GROUND POWER  
 ABOVE GROUND TELCO  
 ABOVE GROUND TELCO/POWER  
 WORKPOINT

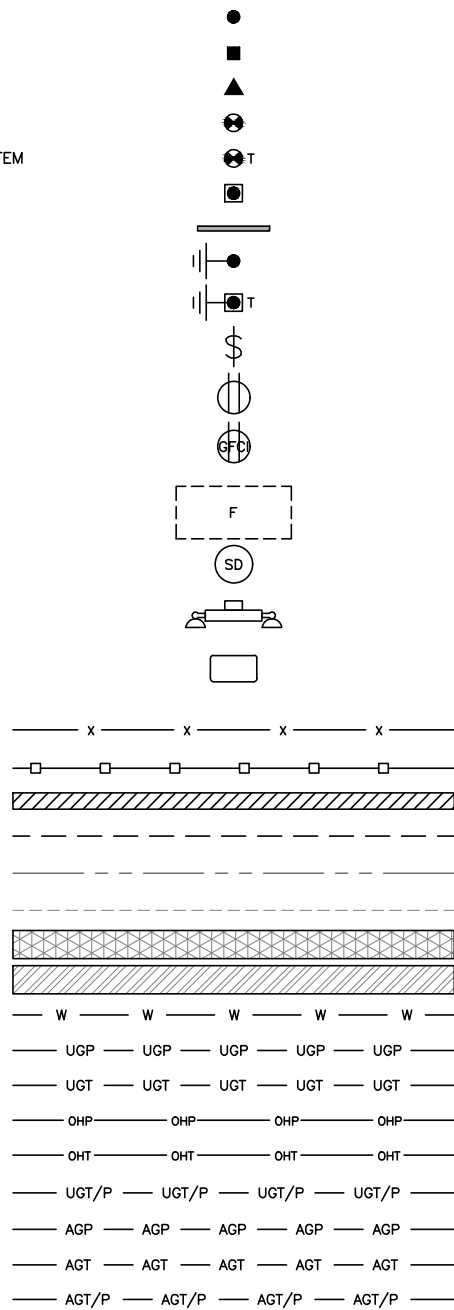

SECTION REFERENCE  
 DETAIL REFERENCE

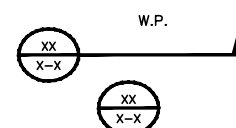

**LEGEND**

AB ANCHOR BOLT  
 ABV ABOVE  
 AC ALTERNATING CURRENT  
 ADDL ADDITIONAL  
 AFF ABOVE FINISHED FLOOR  
 AFG ABOVE FINISHED GRADE  
 AGL ABOVE GROUND LEVEL  
 AIC AMPERAGE INTERRUPTION CAPACITY  
 ALUM ALUMINUM  
 ALT ALTERNATE  
 ANT ANTENNA  
 APPROX APPROXIMATE  
 ARCH ARCHITECTURAL  
 ATS AUTOMATIC TRANSFER SWITCH  
 AWG AMERICAN WIRE GAUGE  
 BATT BATTERY  
 BLDG BUILDING  
 BLK BLOCK  
 BLKG BLOCKING  
 BM BEAM  
 BTC BARE TINNED COPPER CONDUCTOR  
 BOF BOTTOM OF FOOTING  
 CAB CABINET  
 CANT CANTILEVERED  
 CHG CHARGING  
 CLG CEILING  
 CLR CLEAR  
 COL COLUMN  
 COMM COMMON  
 CONC CONCRETE  
 CONSTR CONSTRUCTION  
 DBL DOUBLE  
 DC DIRECT CURRENT  
 DEPT DEPARTMENT  
 DF DOUGLAS FIR  
 DIA DIAMETER  
 DIAG DIAGONAL  
 DIM DIMENSION  
 DWG DRAWING  
 DWL DOWEL  
 EA EACH  
 EC ELECTRICAL CONDUCTOR  
 EL ELEVATION  
 ELEC ELECTRICAL  
 EMT ELECTRICAL METALLIC TUBING  
 ENG ENGINEER  
 EQ EQUAL  
 EXP EXPANSION  
 EXT EXTERIOR  
 EW EACH WAY  
 FAB FABRICATION  
 FF FINISH FLOOR  
 FG FINISH GRADE  
 FIF FACILITY INTERFACE FRAME  
 FIN FINISH(ED)  
 FLR FLOOR  
 FDN FOUNDATION  
 FOC FACE OF CONCRETE  
 FOM FACE OF MASONRY  
 FOS FACE OF STUD  
 FOW FACE OF WALL  
 FS FINISH SURFACE  
 FT FOOT  
 FTG FOOTING  
 GA GAUGE  
 GEN GENERATOR  
 GFCI GROUND FAULT CIRCUIT INTERRUPTER  
 GLB GLUE LAMINATED BEAM  
 GLV GALVANIZED  
 GPS GLOBAL POSITIONING SYSTEM  
 GND GROUND  
 GSM GLOBAL SYSTEM FOR MOBILE  
 HDG HOT DIPPED GALVANIZED  
 HDR HEADER  
 HGR HANGER  
 HVAC HEAT/VENTILATION/AIR CONDITIONING  
 HT HEIGHT  
 IGR INTERIOR GROUND RING

IN INCH  
 INT INTERIOR  
 LB(S) POUND(S)  
 LF LINEAR FEET  
 LTE LONG TERM EVOLUTION  
 MAS MASONRY  
 MAX MAXIMUM  
 MB MACHINE BOLT  
 MECH MECHANICAL  
 MFR MANUFACTURER  
 MGB MASTER GROUND BAR  
 MIN MINIMUM  
 MISC MISCELLANEOUS  
 MTL METAL  
 MTS MANUAL TRANSFER SWITCH  
 MW MICROWAVE  
 NEC NATIONAL ELECTRIC CODE  
 NM NEWTON METERS  
 NO. NUMBER  
 # NUMBER  
 NTS NOT TO SCALE  
 OC ON-CENTER  
 OSHA OCCUPATIONAL SAFETY AND HEALTH ADMINISTRATION  
 OPNG OPENING  
 P/C PRECAST CONCRETE  
 PCS PERSONAL COMMUNICATION SERVICES  
 PCU PRIMARY CONTROL UNIT  
 PRC PRIMARY RADIO CABINET  
 PP POLARIZING PRESERVING  
 PSF POUNDS PER SQUARE FOOT  
 PSI POUNDS PER SQUARE INCH  
 PT PRESSURE TREATED  
 PWR POWER CABINET  
 QTY QUANTITY  
 RAD RADIUS  
 RECT RECTIFIER  
 REF REFERENCE  
 REINF REINFORCEMENT  
 REQ'D REQUIRED  
 RET REMOTE ELECTRIC TILT  
 RF RADIO FREQUENCY  
 RMC RIGID METALLIC CONDUIT  
 RRH REMOTE RADIO HEAD  
 RRU REMOTE RADIO UNIT  
 RWY RACEWAY  
 SCH SCHEDULE  
 SHT SHEET  
 SIAD SMART INTEGRATED ACCESS DEVICE  
 SIM SIMILAR  
 SPEC SPECIFICATION  
 SQ SQUARE  
 SS STAINLESS STEEL  
 STD STANDARD  
 STL STEEL  
 TEMP TEMPORARY  
 THK THICKNESS  
 TMA TOWER MOUNTED AMPLIFIER  
 TN TOE NAIL  
 TOA TOP OF ANTENNA  
 TOC TOP OF CURB  
 TOF TOP OF FOUNDATION  
 TOP TOP OF PLATE (PARAPET)  
 TOS TOP OF STEEL  
 TOW TOP OF WALL  
 TVSS TRANSIENT VOLTAGE SURGE SUPPRESSION  
 TYP TYPICAL  
 UG UNDERGROUND  
 UL UNDERWRITERS LABORATORY  
 UNO UNLESS NOTED OTHERWISE  
 UMTS UNIVERSAL MOBILE TELECOMMUNICATIONS SYSTEM  
 UPS UNINTERRUPTIBLE POWER SYSTEM (DC POWER PLANT)  
 VIF VERIFIED IN FIELD  
 W WIDE  
 W/ WITH  
 WD WOOD  
 WP WEATHERPROOF  
 WT WEIGHT

**ABBREVIATIONS**



5701 SOUTH SANTA FE DRIVE  
 LITTLETON, CO 80120



**NB+C ENGINEERING SERVICES, LLC.**

100 APOLLO DRIVE  
 SUITE 303  
 CHELMSFORD, MA 01824  
 (978) 856-8308



IT IS A VIOLATION OF LAW FOR ANY PERSON,  
 UNLESS THEY ARE ACTING UNDER THE DIRECTION  
 OF A LICENSED PROFESSIONAL ENGINEER,  
 TO ALTER THIS DOCUMENT.

DRAWN BY: CHECKED BY: APPROVED BY:  
 CWE NSB DRG

RFDS REV #: 1

**CONSTRUCTION DOCUMENTS**

SUBMITTALS		
REV	DATE	DESCRIPTION
0	01/20/22	ISSUED FOR CONSTRUCTION
1	06/27/23	UTILITY ROUTES REVISED

A&E PROJECT NUMBER  
**100753**

DISH WIRELESS, LLC.  
 PROJECT INFORMATION  
**BOBOS00343A**

1815 MASSACHUSETTS AVE.  
 CAMBRIDGE, MA 02140

SHEET TITLE  
**LEGEND AND ABBREVIATIONS**

SHEET NUMBER  
**GN-1**



**SITE ACTIVITY REQUIREMENTS:**

1. NOTICE TO PROCEED – NO WORK SHALL COMMENCE PRIOR TO CONTRACTOR RECEIVING A WRITTEN NOTICE TO PROCEED (NTP) AND THE ISSUANCE OF A PURCHASE ORDER. PRIOR TO ACCESSING/ENTERING THE SITE YOU MUST CONTACT THE DISH WIRELESS, LLC. AND TOWER OWNER NOC & THE DISH WIRELESS, LLC. AND TOWER OWNER CONSTRUCTION MANAGER.
2. "LOOK UP" – DISH WIRELESS, LLC. AND TOWER OWNER SAFETY CLIMB REQUIREMENT:  
THE INTEGRITY OF THE SAFETY CLIMB AND ALL COMPONENTS OF THE CLIMBING FACILITY SHALL BE CONSIDERED DURING ALL STAGES OF DESIGN, INSTALLATION, AND INSPECTION. TOWER MODIFICATION, MOUNT REINFORCEMENTS, AND/OR EQUIPMENT INSTALLATIONS SHALL NOT COMPROMISE THE INTEGRITY OR FUNCTIONAL USE OF THE SAFETY CLIMB OR ANY COMPONENTS OF THE CLIMBING FACILITY ON THE STRUCTURE. THIS SHALL INCLUDE, BUT NOT BE LIMITED TO: PINCHING OF THE WIRE ROPE, BENDING OF THE WIRE ROPE FROM ITS SUPPORTS, DIRECT CONTACT OR CLOSE PROXIMITY TO THE WIRE ROPE WHICH MAY CAUSE FRICTIONAL WEAR, IMPACT TO THE ANCHORAGE POINTS IN ANY WAY, OR TO IMPEDE/BLOCK ITS INTENDED USE. ANY COMPROMISED SAFETY CLIMB, INCLUDING EXISTING CONDITIONS MUST BE TAGGED OUT AND REPORTED TO YOUR DISH WIRELESS, LLC. AND DISH WIRELESS, LLC. AND TOWER OWNER POC OR CALL THE NOC TO GENERATE A SAFETY CLIMB MAINTENANCE AND CONTRACTOR NOTICE TICKET.
3. PRIOR TO THE START OF CONSTRUCTION, ALL REQUIRED JURISDICTIONAL PERMITS SHALL BE OBTAINED. THIS INCLUDES, BUT IS NOT LIMITED TO, BUILDING, ELECTRICAL, MECHANICAL, FIRE, FLOOD ZONE, ENVIRONMENTAL, AND ZONING. AFTER ONSITE ACTIVITIES AND CONSTRUCTION ARE COMPLETED, ALL REQUIRED PERMITS SHALL BE SATISFIED AND CLOSED OUT ACCORDING TO LOCAL JURISDICTIONAL REQUIREMENTS.
4. ALL CONSTRUCTION MEANS AND METHODS; INCLUDING BUT NOT LIMITED TO, ERECTION PLANS, RIGGING PLANS, CLIMBING PLANS, AND RESCUE PLANS SHALL BE THE RESPONSIBILITY OF THE GENERAL CONTRACTOR RESPONSIBLE FOR THE EXECUTION OF THE WORK CONTAINED HEREIN, AND SHALL MEET ANSI/ASSE A10.48 (LATEST EDITION); FEDERAL, STATE, AND LOCAL REGULATIONS; AND ANY APPLICABLE INDUSTRY CONSENSUS STANDARDS RELATED TO THE CONSTRUCTION ACTIVITIES BEING PERFORMED. ALL RIGGING PLANS SHALL ADHERE TO ANSI/ASSE A10.48 (LATEST EDITION) AND DISH WIRELESS, LLC. AND TOWER OWNER STANDARDS, INCLUDING THE REQUIRED INVOLVEMENT OF A QUALIFIED ENGINEER FOR CLASS IV CONSTRUCTION, TO CERTIFY THE SUPPORTING STRUCTURE(S) IN ACCORDANCE WITH ANSI/TIA-322 (LATEST EDITION).
5. ALL SITE WORK TO COMPLY WITH DISH WIRELESS, LLC. AND TOWER OWNER INSTALLATION STANDARDS FOR CONSTRUCTION ACTIVITIES ON DISH WIRELESS, LLC. AND TOWER OWNER TOWER SITE AND LATEST VERSION OF ANSI/TIA-1019-A-2012 "STANDARD FOR INSTALLATION, ALTERATION, AND MAINTENANCE OF ANTENNA SUPPORTING STRUCTURES AND ANTENNAS."
6. IF THE SPECIFIED EQUIPMENT CAN NOT BE INSTALLED AS SHOWN ON THESE DRAWINGS, THE CONTRACTOR SHALL PROPOSE AN ALTERNATIVE INSTALLATION FOR APPROVAL BY DISH WIRELESS, LLC. AND TOWER OWNER PRIOR TO PROCEEDING WITH ANY SUCH CHANGE OF INSTALLATION.
7. ALL MATERIALS FURNISHED AND INSTALLED SHALL BE IN STRICT ACCORDANCE WITH ALL APPLICABLE CODES, REGULATIONS AND ORDINANCES. CONTRACTOR SHALL ISSUE ALL APPROPRIATE NOTICES AND COMPLY WITH ALL LAWS, ORDINANCES, RULES, REGULATIONS AND LAWFUL ORDERS OF ANY PUBLIC AUTHORITY REGARDING THE PERFORMANCE OF THE WORK. ALL WORK CARRIED OUT SHALL COMPLY WITH ALL APPLICABLE MUNICIPAL AND UTILITY COMPANY SPECIFICATIONS AND LOCAL JURISDICTIONAL CODES, ORDINANCES AND APPLICABLE REGULATIONS.
8. THE CONTRACTOR SHALL INSTALL ALL EQUIPMENT AND MATERIALS IN ACCORDANCE WITH MANUFACTURER'S RECOMMENDATIONS UNLESS SPECIFICALLY STATED OTHERWISE.
9. THE CONTRACTOR SHALL CONTACT UTILITY LOCATING SERVICES INCLUDING PRIVATE LOCATES SERVICES PRIOR TO THE START OF CONSTRUCTION.
10. ALL EXISTING ACTIVE SEWER, WATER, GAS, ELECTRIC AND OTHER UTILITIES WHERE ENCOUNTERED IN THE WORK, SHALL BE PROTECTED AT ALL TIMES AND WHERE REQUIRED FOR THE PROPER EXECUTION OF THE WORK, SHALL BE RELOCATED AS DIRECTED BY CONTRACTOR. EXTREME CAUTION SHOULD BE USED BY THE CONTRACTOR WHEN EXCAVATING OR DRILLING PIERS AROUND OR NEAR UTILITIES. CONTRACTOR SHALL PROVIDE SAFETY TRAINING FOR THE WORKING CREW. THIS WILL INCLUDE BUT NOT BE LIMITED TO A) FALL PROTECTION B) CONFINED SPACE C) ELECTRICAL SAFETY D) TRENCHING AND EXCAVATION E) CONSTRUCTION SAFETY PROCEDURES.
11. ALL SITE WORK SHALL BE AS INDICATED ON THE STAMPED CONSTRUCTION DRAWINGS AND DISH PROJECT SPECIFICATIONS, LATEST APPROVED REVISION.
12. CONTRACTOR SHALL KEEP THE SITE FREE FROM ACCUMULATING WASTE MATERIAL, DEBRIS, AND TRASH AT THE COMPLETION OF THE WORK. IF NECESSARY, RUBBISH, STUMPS, DEBRIS, STICKS, STONES AND OTHER REFUSE SHALL BE REMOVED FROM THE SITE AND DISPOSED OF LEGALLY.
13. ALL EXISTING INACTIVE SEWER, WATER, GAS, ELECTRIC AND OTHER UTILITIES, WHICH INTERFERE WITH THE EXECUTION OF THE WORK, SHALL BE REMOVED AND/OR CAPPED, PLUGGED OR OTHERWISE DISCONTINUED AT POINTS WHICH WILL NOT INTERFERE WITH THE EXECUTION OF THE WORK, SUBJECT TO THE APPROVAL OF DISH WIRELESS, LLC. AND TOWER OWNER, AND/OR LOCAL UTILITIES.
14. THE CONTRACTOR SHALL PROVIDE SITE SIGNAGE IN ACCORDANCE WITH THE TECHNICAL SPECIFICATION FOR SITE SIGNAGE REQUIRED BY LOCAL JURISDICTION AND SIGNAGE REQUIRED ON INDIVIDUAL PIECES OF EQUIPMENT, ROOMS, AND SHELTERS.
15. THE SITE SHALL BE GRADED TO CAUSE SURFACE WATER TO FLOW AWAY FROM THE CARRIER'S EQUIPMENT AND TOWER AREAS.
16. THE SUB GRADE SHALL BE COMPACTED AND BROUGHT TO A SMOOTH UNIFORM GRADE PRIOR TO FINISHED SURFACE APPLICATION.
17. THE AREAS OF THE OWNERS PROPERTY DISTURBED BY THE WORK AND NOT COVERED BY THE TOWER, EQUIPMENT OR DRIVEWAY, SHALL BE GRADED TO A UNIFORM SLOPE, AND STABILIZED TO PREVENT EROSION AS SPECIFIED ON THE CONSTRUCTION DRAWINGS AND/OR PROJECT SPECIFICATIONS.
18. CONTRACTOR SHALL MINIMIZE DISTURBANCE TO EXISTING SITE DURING CONSTRUCTION. EROSION CONTROL MEASURES, IF REQUIRED DURING CONSTRUCTION, SHALL BE IN CONFORMANCE WITH THE LOCAL GUIDELINES FOR EROSION AND SEDIMENT CONTROL.
19. THE CONTRACTOR SHALL PROTECT EXISTING IMPROVEMENTS, PAVEMENTS, CURBS, LANDSCAPING AND STRUCTURES. ANY DAMAGED PART SHALL BE REPAIRED AT CONTRACTOR'S EXPENSE TO THE SATISFACTION OF OWNER.
20. CONTRACTOR SHALL LEGALLY AND PROPERLY DISPOSE OF ALL SCRAP MATERIALS SUCH AS COAXIAL CABLES AND OTHER ITEMS REMOVED FROM THE EXISTING FACILITY. ANTENNAS AND RADIOS REMOVED SHALL BE RETURNED TO THE OWNER'S DESIGNATED LOCATION.
21. CONTRACTOR SHALL LEAVE PREMISES IN CLEAN CONDITION. TRASH AND DEBRIS SHOULD BE REMOVED FROM SITE ON A DAILY BASIS.
22. NO FILL OR EMBANKMENT MATERIAL SHALL BE PLACED ON FROZEN GROUND. FROZEN MATERIALS, SNOW OR ICE SHALL NOT BE PLACED IN ANY FILL OR EMBANKMENT.

**GENERAL NOTES:**

1. FOR THE PURPOSE OF CONSTRUCTION DRAWING, THE FOLLOWING DEFINITIONS SHALL APPLY:  
CONTRACTOR: GENERAL CONTRACTOR RESPONSIBLE FOR CONSTRUCTION  
CARRIER: DISH WIRELESS, LLC.  
TOWER OWNER: TOWER OWNER
2. THESE DRAWINGS HAVE BEEN PREPARED USING STANDARDS OF PROFESSIONAL CARE AND COMPLETENESS NORMALLY EXERCISED UNDER SIMILAR CIRCUMSTANCES BY REPUTABLE ENGINEERS IN THIS OR SIMILAR LOCALITIES. IT IS ASSUMED THAT THE WORK DEPICTED WILL BE PERFORMED BY AN EXPERIENCED CONTRACTOR AND/OR WORKPEOPLE WHO HAVE A WORKING KNOWLEDGE OF THE APPLICABLE CODE STANDARDS AND REQUIREMENTS AND OF INDUSTRY ACCEPTED STANDARD GOOD PRACTICE. AS NOT EVERY CONDITION OR ELEMENT IS (OR CAN BE) EXPLICITLY SHOWN ON THESE DRAWINGS, THE CONTRACTOR SHALL USE INDUSTRY ACCEPTED STANDARD GOOD PRACTICE FOR MISCELLANEOUS WORK NOT EXPLICITLY SHOWN.
3. THESE DRAWINGS REPRESENT THE FINISHED STRUCTURE. THEY DO NOT INDICATE THE MEANS OR METHODS OF CONSTRUCTION. THE CONTRACTOR SHALL BE SOLELY RESPONSIBLE FOR THE CONSTRUCTION MEANS, METHODS, TECHNIQUES, SEQUENCES, AND PROCEDURES. THE CONTRACTOR SHALL PROVIDE ALL MEASURES NECESSARY FOR PROTECTION OF LIFE AND PROPERTY DURING CONSTRUCTION. SUCH MEASURES SHALL INCLUDE, BUT NOT BE LIMITED TO, BRACING, FORMWORK, SHORING, ETC. SITE VISITS BY THE ENGINEER OR HIS REPRESENTATIVE WILL NOT INCLUDE INSPECTION OF THESE ITEMS AND IS FOR STRUCTURAL OBSERVATION OF THE FINISHED STRUCTURE ONLY.
4. NOTES AND DETAILS IN THE CONSTRUCTION DRAWINGS SHALL TAKE PRECEDENCE OVER GENERAL NOTES AND TYPICAL DETAILS. WHERE NO DETAILS ARE SHOWN, CONSTRUCTION SHALL CONFORM TO SIMILAR WORK ON THE PROJECT, AND/OR AS PROVIDED FOR IN THE CONTRACT DOCUMENTS. WHERE DISCREPANCIES OCCUR BETWEEN PLANS, DETAILS, GENERAL NOTES, AND SPECIFICATIONS, THE GREATER, MORE STRICT REQUIREMENTS, SHALL GOVERN. IF FURTHER CLARIFICATION IS REQUIRED CONTACT THE ENGINEER OF RECORD.
5. SUBSTANTIAL EFFORT HAS BEEN MADE TO PROVIDE ACCURATE DIMENSIONS AND MEASUREMENTS ON THE DRAWINGS TO ASSIST IN THE FABRICATION AND/OR PLACEMENT OF CONSTRUCTION ELEMENTS BUT IT IS THE SOLE RESPONSIBILITY OF THE CONTRACTOR TO FIELD VERIFY THE DIMENSIONS, MEASUREMENTS, AND/OR CLEARANCES SHOWN IN THE CONSTRUCTION DRAWINGS PRIOR TO FABRICATION OR CUTTING OF ANY NEW OR EXISTING CONSTRUCTION ELEMENTS. IF IT IS DETERMINED THAT THERE ARE DISCREPANCIES AND/OR CONFLICTS WITH THE CONSTRUCTION DRAWINGS THE ENGINEER OF RECORD IS TO BE NOTIFIED AS SOON AS POSSIBLE.
6. PRIOR TO THE SUBMISSION OF BIDS, THE BIDDING CONTRACTOR SHALL VISIT THE CELL SITE TO FAMILIARIZE WITH THE EXISTING CONDITIONS AND TO CONFIRM THAT THE WORK CAN BE ACCOMPLISHED AS SHOWN ON THE CONSTRUCTION DRAWINGS. ANY DISCREPANCY FOUND SHALL BE BROUGHT TO THE ATTENTION OF CARRIER POC AND TOWER OWNER.
7. ALL MATERIALS FURNISHED AND INSTALLED SHALL BE IN STRICT ACCORDANCE WITH ALL APPLICABLE CODES, REGULATIONS AND ORDINANCES. CONTRACTOR SHALL ISSUE ALL APPROPRIATE NOTICES AND COMPLY WITH ALL LAWS, ORDINANCES, RULES, REGULATIONS AND LAWFUL ORDERS OF ANY PUBLIC AUTHORITY REGARDING THE PERFORMANCE OF THE WORK. ALL WORK CARRIED OUT SHALL COMPLY WITH ALL APPLICABLE MUNICIPAL AND UTILITY COMPANY SPECIFICATIONS AND LOCAL JURISDICTIONAL CODES, ORDINANCES AND APPLICABLE REGULATIONS.
8. UNLESS NOTED OTHERWISE, THE WORK SHALL INCLUDE FURNISHING MATERIALS, EQUIPMENT, APPURTENANCES AND LABOR NECESSARY TO COMPLETE ALL INSTALLATIONS AS INDICATED ON THE DRAWINGS.
9. THE CONTRACTOR SHALL INSTALL ALL EQUIPMENT AND MATERIALS IN ACCORDANCE WITH MANUFACTURER'S RECOMMENDATIONS UNLESS SPECIFICALLY STATED OTHERWISE.
10. IF THE SPECIFIED EQUIPMENT CAN NOT BE INSTALLED AS SHOWN ON THESE DRAWINGS, THE CONTRACTOR SHALL PROPOSE AN ALTERNATIVE INSTALLATION FOR APPROVAL BY THE CARRIER AND TOWER OWNER PRIOR TO PROCEEDING WITH ANY SUCH CHANGE OF INSTALLATION.
11. CONTRACTOR IS TO PERFORM A SITE INVESTIGATION, BEFORE SUBMITTING BIDS, TO DETERMINE THE BEST ROUTING OF ALL CONDUITS FOR POWER, AND TELCO AND FOR GROUNDING CABLES AS SHOWN IN THE POWER, TELCO, AND GROUNDING PLAN DRAWINGS.
12. THE CONTRACTOR SHALL PROTECT EXISTING IMPROVEMENTS, PAVEMENTS, CURBS, LANDSCAPING AND STRUCTURES. ANY DAMAGED PART SHALL BE REPAIRED AT CONTRACTOR'S EXPENSE TO THE SATISFACTION OF DISH WIRELESS, LLC. AND TOWER OWNER
13. CONTRACTOR SHALL LEGALLY AND PROPERLY DISPOSE OF ALL SCRAP MATERIALS SUCH AS COAXIAL CABLES AND OTHER ITEMS REMOVED FROM THE EXISTING FACILITY. ANTENNAS REMOVED SHALL BE RETURNED TO THE OWNER'S DESIGNATED LOCATION.
14. CONTRACTOR SHALL LEAVE PREMISES IN CLEAN CONDITION. TRASH AND DEBRIS SHOULD BE REMOVED FROM SITE ON A DAILY BASIS.



5701 SOUTH SANTA FE DRIVE  
LITTLETON, CO 80120



**NB+C ENGINEERING SERVICES, LLC.**

100 APOLLO DRIVE  
SUITE 303  
CHELMSFORD, MA 01824  
(978) 856-8308



IT IS A VIOLATION OF LAW FOR ANY PERSON, UNLESS THEY ARE ACTING UNDER THE DIRECTION OF A LICENSED PROFESSIONAL ENGINEER, TO ALTER THIS DOCUMENT.

DRAWN BY:	CHECKED BY:	APPROVED BY:
CWE	NSB	DRG

RFDS REV #: 1

**CONSTRUCTION DOCUMENTS**

SUBMITTALS		
REV	DATE	DESCRIPTION
0	01/20/22	ISSUED FOR CONSTRUCTION
1	06/27/23	UTILITY ROUTES REVISED

A&E PROJECT NUMBER  
**100753**

DISH WIRELESS, LLC.  
PROJECT INFORMATION  
**BOBOS00343A**

1815 MASSACHUSETTS AVE.  
CAMBRIDGE, MA 02140

SHEET TITLE  
**GENERAL NOTES**

SHEET NUMBER  
**GN-2**



**CONCRETE, FOUNDATIONS, AND REINFORCING STEEL:**

1. ALL CONCRETE WORK SHALL BE IN ACCORDANCE WITH THE ACI 301, ACI 318, ACI 336, ASTM A184, ASTM A185 AND THE DESIGN AND CONSTRUCTION SPECIFICATION FOR CAST-IN-PLACE CONCRETE.
2. UNLESS NOTED OTHERWISE, SOIL BEARING PRESSURE USED FOR DESIGN OF SLABS AND FOUNDATIONS IS ASSUMED TO BE 1000 psf.
3. ALL CONCRETE SHALL HAVE A MINIMUM COMPRESSIVE STRENGTH (f'c) OF 3000 psi AT 28 DAYS, UNLESS NOTED OTHERWISE. NO MORE THAN 90 MINUTES SHALL ELAPSE FROM BATCH TIME TO TIME OF PLACEMENT UNLESS APPROVED BY THE ENGINEER OF RECORD. TEMPERATURE OF CONCRETE SHALL NOT EXCEED 90°f AT TIME OF PLACEMENT.
4. CONCRETE EXPOSED TO FREEZE-THAW CYCLES SHALL CONTAIN AIR ENTRAINING ADMIXTURES. AMOUNT OF AIR ENTRAINMENT TO BE BASED ON SIZE OF AGGREGATE AND F3 CLASS EXPOSURE (VERY SEVERE). CEMENT USED TO BE TYPE II PORTLAND CEMENT WITH A MAXIMUM WATER-TO-CEMENT RATIO (W/C) OF 0.45.
5. ALL STEEL REINFORCING SHALL CONFORM TO ASTM A615. ALL WELDED WIRE FABRIC (WWF) SHALL CONFORM TO ASTM A185. ALL SPLICES SHALL BE CLASS "B" TENSION SPLICES, UNLESS NOTED OTHERWISE. ALL HOOKS SHALL BE STANDARD 90 DEGREE HOOKS, UNLESS NOTED OTHERWISE. YIELD STRENGTH (Fy) OF STANDARD DEFORMED BARS ARE AS FOLLOWS:  
 #4 BARS AND SMALLER 40 ksi  
 #5 BARS AND LARGER 60 ksi
6. THE FOLLOWING MINIMUM CONCRETE COVER SHALL BE PROVIDED FOR REINFORCING STEEL UNLESS SHOWN OTHERWISE ON DRAWINGS:
  - CONCRETE CAST AGAINST AND PERMANENTLY EXPOSED TO EARTH 3"
  - CONCRETE EXPOSED TO EARTH OR WEATHER:
    - #6 BARS AND LARGER 2"
    - #5 BARS AND SMALLER 1-1/2"
  - CONCRETE NOT EXPOSED TO EARTH OR WEATHER:
    - SLAB AND WALLS 3/4"
    - BEAMS AND COLUMNS 1-1/2"
7. A TOOLED EDGE OR A 3/4" CHAMFER SHALL BE PROVIDED AT ALL EXPOSED EDGES OF CONCRETE, UNLESS NOTED OTHERWISE, IN ACCORDANCE WITH ACI 301 SECTION 4.2.4.

**ELECTRICAL INSTALLATION NOTES:**

1. ALL ELECTRICAL WORK SHALL BE PERFORMED IN ACCORDANCE WITH THE PROJECT SPECIFICATIONS, NEC AND ALL APPLICABLE FEDERAL, STATE, AND LOCAL CODES/ORDINANCES.
2. CONDUIT ROUTINGS ARE SCHEMATIC. CONTRACTOR SHALL INSTALL CONDUITS SO THAT ACCESS TO EQUIPMENT IS NOT BLOCKED AND TRIP HAZARDS ARE ELIMINATED.
3. WIRING, RACEWAY AND SUPPORT METHODS AND MATERIALS SHALL COMPLY WITH THE REQUIREMENTS OF THE NEC.
4. ALL CIRCUITS SHALL BE SEGREGATED AND MAINTAIN MINIMUM CABLE SEPARATION AS REQUIRED BY THE NEC.
- 4.1. ALL EQUIPMENT SHALL BEAR THE UNDERWRITERS LABORATORIES LABEL OF APPROVAL, AND SHALL CONFORM TO REQUIREMENT OF THE NATIONAL ELECTRICAL CODE.
- 4.2. ALL OVERCURRENT DEVICES SHALL HAVE AN INTERRUPTING CURRENT RATING THAT SHALL BE GREATER THAN THE SHORT CIRCUIT CURRENT TO WHICH THEY ARE SUBJECTED, 22,000 AIC MINIMUM. VERIFY AVAILABLE SHORT CIRCUIT CURRENT DOES NOT EXCEED THE RATING OF ELECTRICAL EQUIPMENT IN ACCORDANCE WITH ARTICLE 110.24 NEC OR THE MOST CURRENT ADOPTED CODE PRE THE GOVERNING JURISDICTION.
5. EACH END OF EVERY POWER PHASE CONDUCTOR, GROUNDING CONDUCTOR, AND TELCO CONDUCTOR OR CABLE SHALL BE LABELED WITH COLOR-CODED INSULATION OR ELECTRICAL TAPE (3M BRAND, 1/2" PLASTIC ELECTRICAL TAPE WITH UV PROTECTION, OR EQUAL). THE IDENTIFICATION METHOD SHALL CONFORM WITH NEC AND OSHA.
6. ALL ELECTRICAL COMPONENTS SHALL BE CLEARLY LABELED WITH LAMICOID TAGS SHOWING THEIR RATED VOLTAGE, PHASE CONFIGURATION, WIRE CONFIGURATION, POWER OR AMPACITY RATING AND BRANCH CIRCUIT ID NUMBERS (i.e. PANEL BOARD AND CIRCUIT ID'S).
7. PANEL BOARDS (ID NUMBERS) SHALL BE CLEARLY LABELED WITH PLASTIC LABELS.
8. TIE WRAPS ARE NOT ALLOWED.
9. ALL POWER AND EQUIPMENT GROUND WIRING IN TUBING OR CONDUIT SHALL BE SINGLE COPPER CONDUCTOR (#14 OR LARGER) WITH TYPE THHW, THWN, THWN-2, XHHW, XHHW-2, THW, THW-2, RHW, OR RHW-2 INSULATION UNLESS OTHERWISE SPECIFIED.
10. SUPPLEMENTAL EQUIPMENT GROUND WIRING LOCATED INDOORS SHALL BE SINGLE COPPER CONDUCTOR (#6 OR LARGER) WITH TYPE THHW, THWN, THWN-2, XHHW, XHHW-2, THW, THW-2, RHW, OR RHW-2 INSULATION UNLESS OTHERWISE SPECIFIED.
11. POWER AND CONTROL WIRING IN FLEXIBLE CORD SHALL BE MULTI-CONDUCTOR, TYPE SOOW CORD (#14 OR LARGER) UNLESS OTHERWISE SPECIFIED.
12. POWER AND CONTROL WIRING FOR USE IN CABLE TRAY SHALL BE MULTI-CONDUCTOR, TYPE TC CABLE (#14 OR LARGER), WITH TYPE THHW, THWN, THWN-2, XHHW, XHHW-2, THW, THW-2, RHW, OR RHW-2 INSULATION UNLESS OTHERWISE SPECIFIED.
13. ALL POWER AND GROUNDING CONNECTIONS SHALL BE CRIMP-STYLE, COMPRESSION WIRE LUGS AND WIRE NUTS BY THOMAS AND BETTS (OR EQUAL). LUGS AND WIRE NUTS SHALL BE RATED FOR OPERATION NOT LESS THAN 75° C (90° C IF AVAILABLE).
14. RACEWAY AND CABLE TRAY SHALL BE LISTED OR LABELED FOR ELECTRICAL USE IN ACCORDANCE WITH NEMA, UL, ANSI/IEEE AND NEC.
15. ELECTRICAL METALLIC TUBING (EMT), INTERMEDIATE METAL CONDUIT (IMC), OR RIGID METAL CONDUIT (RMC) SHALL BE USED FOR EXPOSED INDOOR LOCATIONS.

16. ELECTRICAL METALLIC TUBING (EMT) OR METAL-CLAD CABLE (MC) SHALL BE USED FOR CONCEALED INDOOR LOCATIONS.
17. SCHEDULE 40 PVC UNDERGROUND ON STRAIGHTS AND SCHEDULE 80 PVC FOR ALL ELBOWS/90s AND ALL APPROVED ABOVE GRADE PVC CONDUIT.
18. LIQUID-TIGHT FLEXIBLE METALLIC CONDUIT (LIQUID-TITE FLEX) SHALL BE USED INDOORS AND OUTDOORS, WHERE VIBRATION OCCURS OR FLEXIBILITY IS NEEDED.
19. CONDUIT AND TUBING FITTINGS SHALL BE THREADED OR COMPRESSION-TYPE AND APPROVED FOR THE LOCATION USED. SET SCREW FITTINGS ARE NOT ACCEPTABLE.
20. CABINETS, BOXES AND WIRE WAYS SHALL BE LABELED FOR ELECTRICAL USE IN ACCORDANCE WITH NEMA, UL, ANSI/IEEE AND THE NEC.
21. WIREWAYS SHALL BE METAL WITH AN ENAMEL FINISH AND INCLUDE A HINGED COVER, DESIGNED TO SWING OPEN DOWNWARDS (WIREMOLD SPECMATE WIREWAY).
22. SLOTTED WIRING DUCT SHALL BE PVC AND INCLUDE COVER (PANDUIT TYPE E OR EQUAL).
23. CONDUITS SHALL BE FASTENED SECURELY IN PLACE WITH APPROVED NON-PERFORATED STRAPS AND HANGERS. EXPLOSIVE DEVICES (i.e. POWDER-ACTUATED) FOR ATTACHING HANGERS TO STRUCTURE WILL NOT BE PERMITTED. CLOSELY FOLLOW THE LINES OF THE STRUCTURE, MAINTAIN CLOSE PROXIMITY TO THE STRUCTURE AND KEEP CONDUITS IN TIGHT ENVELOPES. CHANGES IN DIRECTION TO ROUTE AROUND OBSTACLES SHALL BE MADE WITH CONDUIT OUTLET BODIES. CONDUIT SHALL BE INSTALLED IN A NEAT AND WORKMANLIKE MANNER. PARALLEL AND PERPENDICULAR TO STRUCTURE WALL AND CEILING LINES. ALL CONDUIT SHALL BE FISHED TO CLEAR OBSTRUCTIONS. ENDS OF CONDUITS SHALL BE TEMPORARILY CAPPED FLUSH TO FINISH GRADE TO PREVENT CONCRETE, PLASTER OR DIRT FROM ENTERING. CONDUITS SHALL BE RIGIDLY CLAMPED TO BOXES BY GALVANIZED MALLEABLE IRON BUSHING ON INSIDE AND GALVANIZED MALLEABLE IRON LOCKNUT ON OUTSIDE AND INSIDE.
24. EQUIPMENT CABINETS, TERMINAL BOXES, JUNCTION BOXES AND PULL BOXES SHALL BE GALVANIZED OR EPOXY-COATED SHEET STEEL. SHALL MEET OR EXCEED UL 50 AND BE RATED NEMA 1 (OR BETTER) FOR INTERIOR LOCATIONS AND NEMA 3 (OR BETTER) FOR EXTERIOR LOCATIONS.
25. METAL RECEPTACLE, SWITCH AND DEVICE BOXES SHALL BE GALVANIZED, EPOXY-COATED OR NON-CORRODING; SHALL MEET OR EXCEED UL 514A AND NEMA OS 1 AND BE RATED NEMA 1 (OR BETTER) FOR INTERIOR LOCATIONS AND WEATHER PROTECTED (WP OR BETTER) FOR EXTERIOR LOCATIONS.
26. NONMETALLIC RECEPTACLE, SWITCH AND DEVICE BOXES SHALL MEET OR EXCEED NEMA OS 2 (NEWEST REVISION) AND BE RATED NEMA 1 (OR BETTER) FOR INTERIOR LOCATIONS AND WEATHER PROTECTED (WP OR BETTER) FOR EXTERIOR LOCATIONS.
27. THE CONTRACTOR SHALL NOTIFY AND OBTAIN NECESSARY AUTHORIZATION FROM THE CARRIER AND/OR DISH WIRELESS, LLC. AND TOWER OWNER BEFORE COMMENCING WORK ON THE AC POWER DISTRIBUTION PANELS.
28. THE CONTRACTOR SHALL PROVIDE NECESSARY TAGGING ON THE BREAKERS, CABLES AND DISTRIBUTION PANELS IN ACCORDANCE WITH THE APPLICABLE CODES AND STANDARDS TO SAFEGUARD LIFE AND PROPERTY.
29. INSTALL LAMICOID LABEL ON THE METER CENTER TO SHOW "DISH WIRELESS, LLC."
30. ALL EMPTY/SPARE CONDUITS THAT ARE INSTALLED ARE TO HAVE A METERED MULE TAPE PULL CORD INSTALLED.



5701 SOUTH SANTA FE DRIVE  
LITTLETON, CO 80120



**NB+C ENGINEERING SERVICES, LLC.**

100 APOLLO DRIVE  
SUITE 303  
CHELMSFORD, MA 01824  
(978) 856-8308



IT IS A VIOLATION OF LAW FOR ANY PERSON, UNLESS THEY ARE ACTING UNDER THE DIRECTION OF A LICENSED PROFESSIONAL ENGINEER, TO ALTER THIS DOCUMENT.

DRAWN BY:	CHECKED BY:	APPROVED BY:
CWE	NSB	DRG

RFDS REV #: 1

**CONSTRUCTION DOCUMENTS**

SUBMITTALS		
REV	DATE	DESCRIPTION
0	01/20/22	ISSUED FOR CONSTRUCTION
1	06/27/23	UTILITY ROUTES REVISED

A&E PROJECT NUMBER  
**100753**

DISH WIRELESS, LLC.  
PROJECT INFORMATION  
**BOBOS00343A**

1815 MASSACHUSETTS AVE.  
CAMBRIDGE, MA 02140

SHEET TITLE  
**GENERAL NOTES**

SHEET NUMBER  
**GN-3**

**GROUNDING NOTES:**

1. ALL GROUND ELECTRODE SYSTEMS (INCLUDING TELECOMMUNICATION, RADIO, LIGHTNING PROTECTION AND AC POWER GES'S) SHALL BE BONDED TOGETHER AT OR BELOW GRADE, BY TWO OR MORE COPPER BONDING CONDUCTORS IN ACCORDANCE WITH THE NEC.
2. THE CONTRACTOR SHALL PERFORM IEEE FALL-OF-POTENTIAL RESISTANCE TO EARTH TESTING (PER IEEE 1100 AND 81) FOR GROUND ELECTRODE SYSTEMS, THE CONTRACTOR SHALL FURNISH AND INSTALL SUPPLEMENTAL GROUND ELECTRODES AS NEEDED TO ACHIEVE A TEST RESULT OF 5 OHMS OR LESS.
3. THE CONTRACTOR IS RESPONSIBLE FOR PROPERLY SEQUENCING GROUNDING AND UNDERGROUND CONDUIT INSTALLATION AS TO PREVENT ANY LOSS OF CONTINUITY IN THE GROUNDING SYSTEM OR DAMAGE TO THE CONDUIT AND PROVIDE TESTING RESULTS.
4. METAL CONDUIT AND TRAY SHALL BE GROUNDED AND MADE ELECTRICALLY CONTINUOUS WITH LISTED BONDING FITTINGS OR BY BONDING ACROSS THE DISCONTINUITY WITH #6 COPPER WIRE UL APPROVED GROUNDING TYPE CONDUIT CLAMPS.
5. METAL RACEWAY SHALL NOT BE USED AS THE NEC REQUIRED EQUIPMENT GROUND CONDUCTOR. STRANDED COPPER CONDUCTORS WITH GREEN INSULATION, SIZED IN ACCORDANCE WITH THE NEC, SHALL BE FURNISHED AND INSTALLED WITH THE POWER CIRCUITS TO BTS EQUIPMENT.
6. EACH CABINET FRAME SHALL BE DIRECTLY CONNECTED TO THE MASTER GROUND BAR WITH GREEN INSULATED SUPPLEMENTAL EQUIPMENT GROUND WIRES, #6 STRANDED COPPER OR LARGER FOR INDOOR BTS; #2 BARE SOLID TINNED COPPER FOR OUTDOOR BTS.
7. CONNECTIONS TO THE GROUND BUS SHALL NOT BE DOUBLED UP OR STACKED BACK TO BACK CONNECTIONS ON OPPOSITE SIDE OF THE GROUND BUS ARE PERMITTED.
8. ALL EXTERIOR GROUND CONDUCTORS BETWEEN EQUIPMENT/GROUND BARS AND THE GROUND RING SHALL BE #2 SOLID TINNED COPPER UNLESS OTHERWISE INDICATED.
9. ALUMINUM CONDUCTOR OR COPPER CLAD STEEL CONDUCTOR SHALL NOT BE USED FOR GROUNDING CONNECTIONS.
10. USE OF 90° BENDS IN THE PROTECTION GROUNDING CONDUCTORS SHALL BE AVOIDED WHEN 45° BENDS CAN BE ADEQUATELY SUPPORTED.
11. EXOTHERMIC WELDS SHALL BE USED FOR ALL GROUNDING CONNECTIONS BELOW GRADE.
12. ALL GROUND CONNECTIONS ABOVE GRADE (INTERIOR AND EXTERIOR) SHALL BE FORMED USING HIGH PRESS CRIMPS.
13. COMPRESSION GROUND CONNECTIONS MAY BE REPLACED BY EXOTHERMIC WELD CONNECTIONS.
14. ICE BRIDGE BONDING CONDUCTORS SHALL BE EXOTHERMICALLY BONDED OR BOLTED TO THE BRIDGE AND THE TOWER GROUND BAR.
15. APPROVED ANTIOXIDANT COATINGS (i.e. CONDUCTIVE GEL OR PASTE) SHALL BE USED ON ALL COMPRESSION AND BOLTED GROUND CONNECTIONS.
16. ALL EXTERIOR GROUND CONNECTIONS SHALL BE COATED WITH A CORROSION RESISTANT MATERIAL.
17. MISCELLANEOUS ELECTRICAL AND NON-ELECTRICAL METAL BOXES, FRAMES AND SUPPORTS SHALL BE BONDED TO THE GROUND RING, IN ACCORDANCE WITH THE NEC.
18. BOND ALL METALLIC OBJECTS WITHIN 6 ft OF MAIN GROUND RING WITH (1) #2 BARE SOLID TINNED COPPER GROUND CONDUCTOR.
19. GROUND CONDUCTORS USED FOR THE FACILITY GROUNDING AND LIGHTNING PROTECTION SYSTEMS SHALL NOT BE ROUTED THROUGH METALLIC OBJECTS THAT FORM A RING AROUND THE CONDUCTOR, SUCH AS METALLIC CONDUITS, METAL SUPPORT CLIPS OR SLEEVES THROUGH WALLS OR FLOORS. WHEN IT IS REQUIRED TO BE HOUSED IN CONDUIT TO MEET CODE REQUIREMENTS OR LOCAL CONDITIONS, NON-METALLIC MATERIAL SUCH AS PVC CONDUIT SHALL BE USED. WHERE USE OF METAL CONDUIT IS UNAVOIDABLE (i.e., NONMETALLIC CONDUIT PROHIBITED BY LOCAL CODE) THE GROUND CONDUCTOR SHALL BE BONDED TO EACH END OF THE METAL CONDUIT.
20. ALL GROUNDS THAT TRANSITION FROM BELOW GRADE TO ABOVE GRADE MUST BE #2 BARE SOLID TINNED COPPER IN 3/4" NON-METALLIC, FLEXIBLE CONDUIT FROM 24" BELOW GRADE TO WITHIN 3" TO 6" OF CAD-WELD TERMINATION POINT. THE EXPOSED END OF THE CONDUIT MUST BE SEALED WITH SILICONE CAULK. (ADD TRANSITIONING GROUND STANDARD DETAIL AS WELL).
21. BUILDINGS WHERE THE MAIN GROUNDING CONDUCTORS ARE REQUIRED TO BE ROUTED TO GRADE, THE CONTRACTOR SHALL ROUTE TWO GROUNDING CONDUCTORS FROM THE ROOFTOP, TOWERS, AND WATER TOWERS GROUNDING RING, TO THE EXISTING GROUNDING SYSTEM, THE GROUNDING CONDUCTORS SHALL NOT BE SMALLER THAN 2/0 COPPER. ROOFTOP GROUNDING RING SHALL BE BONDED TO THE EXISTING GROUNDING SYSTEM, THE BUILDING STEEL COLUMNS, LIGHTNING PROTECTION SYSTEM, AND BUILDING MAIN WATER LINE (FERROUS OR NONFERROUS METAL PIPING ONLY). DO NOT ATTACH GROUNDING TO FIRE SPRINKLER SYSTEM PIPES.



5701 SOUTH SANTA FE DRIVE  
LITTLETON, CO 80120



**NB+C ENGINEERING SERVICES, LLC.**

100 APOLLO DRIVE  
SUITE 303  
CHELMSFORD, MA 01824  
(978) 856-8308



IT IS A VIOLATION OF LAW FOR ANY PERSON, UNLESS THEY ARE ACTING UNDER THE DIRECTION OF A LICENSED PROFESSIONAL ENGINEER, TO ALTER THIS DOCUMENT.

DRAWN BY:	CHECKED BY:	APPROVED BY:
CWE	NSB	DRG

RFDS REV #: 1

**CONSTRUCTION DOCUMENTS**

SUBMITTALS		
REV	DATE	DESCRIPTION
0	01/20/22	ISSUED FOR CONSTRUCTION
1	06/27/23	UTILITY ROUTES REVISED

A&E PROJECT NUMBER  
**100753**

DISH WIRELESS, LLC.  
PROJECT INFORMATION  
**BOBOS00343A**  
**1815 MASSACHUSETTS AVE.**  
**CAMBRIDGE, MA 02140**

SHEET TITLE  
**GENERAL NOTES**

SHEET NUMBER  
**GN-4**





**View 3**

**View 2**

**View 1**

**Site**

**BOBOS00343A**  
**Location Map**

Common Place  
 - not visible - visible

Pathway Lofts

Nails By Porter

Caffè Nero - Porter Square

Porter Square Family Dental

Hotel 1868  
Booking.com · Hotels

Anna's Taqueria  
Mexican

Target Grocery

Lesley College

Somerville Ave

Malin Realty

Blue Moon Health Source

Mt Vernon St

Massachusetts Ave

Sapporo Ramen  
Order from Sapporo Ramen

Lesley University  
Porter Campus

Lesley Bookstore  
Book store

Paper Source  
Stationery store

Dan Bolton, LMHC

Roseland St

Roseland St

Roseland St

Arlington St

Lunder Arts Center

Bookcase Factory Outlet

Arlington St

Yoga Within

Frost Terrace

Frost Terrace Apartments

Bagelsaurus

Mass Ave

Frost St

Beacon St

Bicycle R





**Site Name: BOBOS00343A**  
Wireless Communication Facility  
1815 Massachusetts Avenue  
Cambridge, MA 02140

*Photograph Information:*  
View 1-Massachusetts Avenue  
View from the Southwest  
**Showing the Existing Site**







Proposed Gamma  
Sector Antenna

Proposed Beta  
Sector Antenna

**Site Name: BOBOS00343A**  
Wireless Communication Facility  
1815 Massachusetts Avenue  
Cambridge, MA 02140

*Photograph Information:*  
View 1-Massachusetts Avenue  
View from the Southwest  
**Showing the Proposed Site**

**NB+C**<sup>TM</sup>  
TOTALLY COMMITTED.





**Site Name: BOBOS00343A**  
Wireless Communication Facility  
1815 Massachusetts Avenue  
Cambridge, MA 02140

*Photograph Information:*  
View 2-Massachusetts Avenue  
View from the West  
**Showing the Existing Site**

**NBC**  
TOTALLY COMMITTED.





Proposed Gamma  
Sector Antenna

Proposed Alpha  
Sector Antenna

**Site Name: BOBOS00343A**  
Wireless Communication Facility  
1815 Massachusetts Avenue  
Cambridge, MA 02140

*Photograph Information:*  
View 2-Massachusetts Avenue  
View from the West  
**Showing the Proposed Site**

**NBC**  
TOTALLY COMMITTED.





**Site Name: BOBOS00343A**  
Wireless Communication Facility  
1815 Massachusetts Avenue  
Cambridge, MA 02140

*Photograph Information:*  
View 3-Massachusetts Avenue  
View from the Northwest  
**Showing the Existing Site**







cGMP Biopharma Storage  
SciSafe.com

COMMONWEALTH LOCK CO  
WHOLESALE LOCKSMITH SUPPLIES

Proposed Alpha Sector Antenna

Proposed Gamma Sector Antenna

Site Name: BOBOS00343A  
Wireless Communication Facility  
1815 Massachusetts Avenue  
Cambridge, MA 02140

Photograph Information:  
View 3-Massachusetts Avenue  
View from the Northwest  
Showing the Proposed Site

**NBIC**<sup>TM</sup>  
TOTALLY COMMITTED.



NO RIDING ON SIDEWALK



September 25, 2023

Via Federal Express and Online Filing

City of Cambridge  
Board of Zoning Appeal  
831 Massachusetts Avenue  
Cambridge, MA 02139

**RE: Request of DISH Wireless, LLC ("DISH") for Administrative Review of an Eligible Facilities Request to Install Transmission Equipment on the existing 42' above ground level ("AGL") building (the "Building") located at 1815 Massachusetts Avenue, Cambridge MA 02140 (Assessor's Parcel Identification Map 152, Lot 51), pursuant to Section 6409(a) of the Middle Class Tax Relief and Job Creation Act of 2012 (the "Spectrum Act") and Special Permit pursuant to: Article 4, Section 4.32.g.1; Article 4, Section 4.40 (Footnote 49); and Article 10, Section 10.40 of the City of Cambridge Zoning Ordinance; Massachusetts General Laws, Ch 40A, Section 9; the Telecommunications Act of 1996 (the "TCA"), and the Spectrum Act, all rights reserved.**

Dear Honorable Members of the Cambridge Board of Zoning Appeal:

On behalf of DISH, while reserving all rights, we are pleased to submit this Eligible Facilities Request and Special Permit Application (the "Application") to the City of Cambridge Board of Zoning Appeals (the "Board") in support of DISH's request to add Transmission Equipment on the existing Building located at 1815 Massachusetts Avenue, Cambridge, MA 02140 (Assessor's Parcel Identification Map 152, Lot 51) (the "Site"). Capitalized terms not defined herein shall have the same meaning as provided in the Spectrum Act and Regulations (defined below).

As noted on the attached plans (the "Plans"), the Building is owned by Lesley College and other wireless communications services providers (i.e. Verizon Wireless) currently have Transmission Equipment mounted on the Building. DISH proposes to modify the existing wireless communication facility Base Station by collocating its Facility on and the Building. The property is located in the Business C zoning district. As depicted on the Plans, DISH proposes to mount three (3) panel antennas (one (1) antenna per sector) on the façade of the Building. Two (2) of the proposed antennas will be mounted at an antenna centerline height of 63' 10" AGL, and one (1) antenna at a centerline height of 80'. The height of the proposed antennas will not exceed the height of the penthouse of the Building. DISH will also install on the exterior of the Building and adjacent to the antennas six (6) Remote Radio Units, and three (3) over voltage protection devices. DISH will install equipment on a proposed equipment platform on the roof of the Building. DISH's facility (the "Facility") will include related



amplifiers, cables, fiber and other associated antenna equipment, including a global positioning system antenna, all as depicted on the Plans.

DISH's Facility will comply with all applicable terms and conditions of the Cambridge Zoning Ordinance (the "Ordinance"). As the proposed antennas of the Facility will be camouflaged by being painted to match the Building color behind them, there will be no undue adverse impacts upon historic resources, scenic views, residential property values or man-made resources and the aesthetic qualities of the City are preserved. The Facility will be passive in nature and will not generate unreasonable noise, odors, smoke, waste, or significant amounts of traffic. This is an unmanned facility and will not have negative effects upon adjoining lots. The Facility will comply with all applicable federal, state and local laws, regulations and guidelines, including applicable radio frequency emissions standards.

DISH, while reserving all rights, respectfully requests, to the extent necessary, that a special permit be granted so that the antennas may be installed consistent with the Plans submitted herewith.

#### **ELIGIBLE FACILITIES REQUEST**

On behalf of DISH, while reserving all rights, we seek approval of the facility as depicted on the Plans as an Eligible Facilities Request. As you may know, Section 6409(a) of the "Spectrum Act" (copy attached) mandates that state and local governments *"may not deny, and shall approve, any eligible facilities request for a modification of an existing wireless tower or base station that does not substantially change the physical dimensions of such tower or base station."* [emphasis added]. Under Section 6409(a)(2)(A)-(C), an Eligible Facilities Request is any request to modify a Tower or Base Station that involves "collocations of new Transmission Equipment," "removal," or "replacement" of Transmission Equipment.

Federal law now preempts many of the permit application requirements that the City of Cambridge may previously have required from an applicant and provides for a limited, administrative review of DISH's Eligible Facilities Request application. This Eligible Facilities Request involves an effort to collocate, remove, modify, or replace Transmission Equipment on an existing Building used by an FCC licensed wireless carrier. The existing Building is a Structure that is 42' AGL supporting wireless Transmission Equipment. DISH seeks administrative approval for the proposed equipment which is clearly an Eligible Facilities Request which does not substantially change the physical dimensions of the Building pursuant to Section 6409 of the Spectrum Act. DISH proposes to mount three (3) panel antennas (one per sector) on the façade of the penthouse of the Building. The proposed antennas will be mounted at the antenna centerline heights of 63'10" and 80'. DISH will also install six (6) Remote Radio Units, and three (3) over voltage protection devices on the Building as shown in the plans attached hereto. DISH will install equipment on a proposed equipment platform on the roof of the Building. DISH's Facility will include related amplifiers, cables, fiber and other associated antenna equipment, including a global positioning system antenna, all as depicted on the Plans submitted herewith.



The equipment identified on the Plans submitted as part of this Eligible Facilities Request application that will be collocated is Transmission Equipment pursuant to the FCC definition. The FCC has defined Transmission Equipment as “any equipment that facilitates transmission for any Commission-licensed or authorized wireless communication service, including, but not limited to, radio transceivers, antennas and other relevant equipment associated with and necessary to their operation, including coaxial or fiber-optic cable, and regular and back-up power supply. This definition includes equipment used in any technological configuration associated with any Commission-authorized wireless transmission, licensed or unlicensed, terrestrial or satellite, including commercial mobile, private mobile, broadcast and public safety services, as well as fixed wireless services such as microwave backhaul or fixed broadband.”

As you may also know, the FCC adopted a Report and Order, In re: Acceleration of Broadband Deployment by Improving Wireless Facilities Siting Policies, FCC Docket No.13-238, Report and Order No. 14-153 (October 17, 2014) Final Rule codified at 47 CFR Parts 1 and 17 promulgating regulations (the "Regulations") interpreting and implementing the provisions of the Spectrum Act, which Regulations became effective on April 8, 2015 (with certain provisions effective on May 18, 2015). The Regulations determined that any modification to a Base Station, that meets the following six criteria does not substantially change the physical dimensions of the existing Building and, therefore, is an Eligible Facilities Request which must be granted:

1. The modifications do not increase the height of the Building by more than ten feet (10') or ten percent (10%), whichever is greater.
2. The modifications do not protrude from the edge of the Building by more than six feet (6').
3. The modifications do not involve the installation of more than the standard number of equipment cabinets for the technology involved, not to exceed four.
4. The modifications do not entail any excavation or deployment outside of the Site.
5. The modifications do not defeat any existing concealment elements of the Base Station.
6. The modifications comply with prior conditions of approval of the Base Station, unless the non-compliance is due to an increase in height, increase in width, addition of equipment cabinets, or new excavation that does not exceed the corresponding “substantial change” thresholds in numbers 1-4 above.

As evidenced on the Plans, this Eligible Facilities Request satisfies each of the six review criteria enumerated by the FCC in the Regulations. In accordance with the Spectrum Act and the Regulations, DISH's proposed equipment will not increase the height of the Building nor protrude from the edge of the Building by more than six feet (6'). DISH does not propose excavating outside of the Site and is not adding more than the standard number of equipment





cabinets. Lastly, DISH's proposed equipment will not defeat any concealment elements because the antennas will be painted to match the Building similar to the other existing antennas on the Building. DISH's Transmission Equipment at the Building contained in this Eligible Facilities Request fully conforms to Section 6409(a) of the Spectrum Act.

While the Ordinance may provide that a special permit or other zoning relief is required for modifications and colocations, such a discretionary process is contrary to the guidance issued by the FCC in its Public Notice (the "Public Notice") dated January 25, 2013 and the Massachusetts Office of the Attorney General (the "Attorney General") in response letters to municipalities granting approvals of bylaw amendments.

In its Public Notice, the FCC determined that the relevant government entity may require the filing of an application for "administrative approval" only. Additionally, pursuant to Section 1.40001(c)(1) of the Regulations, "when an applicant asserts in writing that a request for a modification is covered by this section, a State or local government may require the applicant to provide documentation or information only to the extent reasonably related to determining whether the request meets the requirements of this section." The Regulations provide that applicants are not required to justify a need for the facility. Further, the Regulations also require that local governmental approvals must be granted for eligible facilities requests within 60 days of the date that the application is submitted. Clearly, this review may not be subject to a discretionary special permit process with the associated public hearing and appeal period provisions. Likewise, the Attorney General has issued a number of letters to municipalities reflecting that same opinion and warning municipalities that such qualifying requests under Section 6409 cannot be subject to a discretionary special permit process. We are confident that you will agree that DISH's proposed equipment does not substantially change the physical dimensions of the Eligible Support Structure or Base Station at the Site, as enumerated in the Regulations.

## **SPECIAL PERMIT**

### **10.43 Criteria.**

**Special permits will normally be granted where specific provisions of this Ordinance are met, except when particulars of the location or use, not generally true of the district or of the uses permitted in it, would cause granting of such permit to be to the detriment of the public interest because:**

**(a) It appears that requirements of this Ordinance cannot or will not be met, or**

DISH's Facility will comply with all applicable sections of the Ordinance as the proposed antennas will be painted to match the Building to which they are attached, will not increase the height of the Building, and will not exceed the height of the existing antennas on the Building.



- (b) **traffic generated or patterns of access or egress would cause congestion, hazard, or substantial change in established neighborhood character, or**

DISH's Facility will not result in any substantial change in the character of the neighborhood as there will be no significant increase in the amount of traffic to and from the Site, or any changes to existing patterns of access or egress to the Site. Trips to and from the Facility will average one or two per month by maintenance personnel.

- (c) **the continued operation of or the development of adjacent uses as permitted in the Zoning Ordinance would be adversely affected by the nature of the proposed use, or**

The continued operation of or the development of adjacent uses will not be adversely affected by DISH's equipment because DISH's Facility will be a passive use and will not produce any smoke, odors, waste, glare, dust, or unreasonable amounts of traffic.

- (d) **nuisance or hazard would be created to the detriment of the health, safety and/or welfare of the occupant of the proposed use or the citizens of the City, or**

DISH's Facility will not result in any nuisance or hazard to the detriment of the health, safety, or welfare of the citizens of the City because DISH's Facility will be a passive use and will not produce any smoke, odors, waste, glare, dust, or unreasonable amounts of traffic. As evidenced by the MPE Study submitted herewith, DISH's Facility will comply with all applicable regulations and guidelines pertaining to radio frequency emissions.

- (e) **for other reasons, the proposed use would impair the integrity of the district or adjoining district, or otherwise derogate from the intent and purpose of this Ordinance, and**

The proposed Facility will be in harmony with the purposes of the Ordinance because by collocating a wireless facility on an existing Building in a manner which does not increase the height of the Building or expand its footprint, potential visual impacts are minimized. Also, the proposed Facility will not produce any smoke, odors, waste, glare or significant amounts of traffic. The Facility will have no negative impact on natural or undeveloped areas, wildlife, flora or endangered species. Consistent with the Ordinance, the Facility will function as a wireless communications services facility within a local, regional, and national communications system. This system operates under licenses from the FCC, and DISH is mandated and authorized to provide adequate service to the general public. The proposed Facility will comply with all applicable regulations, standards and guidelines with respect to radiofrequency emissions.



The Facility will benefit those living and working in, and traveling through, the area by providing enhanced wireless telecommunication services. The Facility will not adversely impact adjacent properties and neighborhoods as the Facility will be located on an existing Building. The collocation of the facility will not be a threat to public health, safety and welfare. In fact, Applicant submits that the facility aids in public safety by providing and improving wireless communications services to the residents, businesses, commuters, and emergency personnel utilizing wireless communications in the immediate vicinity and along the nearby roads. Consistent with the Ordinance, the Facility will function as a wireless communications services facility within a local, regional, and national communications system. This system operates under license from the FCC, and DISH is mandated and authorized to provide adequate service to the general public. The Facility will not generate any objectionable noise, odor, fumes, glare, smoke, or dust or require additional lighting or signage. The Facility will have no negative impact on property values in the area. This is an unmanned Facility and will have minimal negative effect on the adjoining lots.

**(f) the new use or building construction is inconsistent with the Urban Design Objectives set forth in Section 19.30.**

DISH's Facility will not be inconsistent with the Citywide Urban Design Objectives of Section 19.30 of the Ordinance because DISH's Facility will not result in an increase in the height of the Building or any alteration of existing setbacks on the Site. DISH's equipment will not result in any significant increase in traffic to or from the Site and will not adversely impact upon pedestrians or bicyclists and, as DISH's Facility will be unmanned, it will have no impact on parking on Site or the surrounding area. DISH's antennas will be located on the Building in a camouflaged manner and will be painted to match the Building to which they are attached. DISH's Facility will not produce any waste and noise levels on Site will not increase as a result of DISH's Facility, nor will there be any additional exterior lighting as a result of DISH's Facility.

DISH's Facility will operate using standard electric and telephone services. As the Facility will be unmanned, it will require no water or sewer services, and City infrastructure will not be overburdened.

## **THE TELECOMMUNICATIONS ACT OF 1996 - THE TCA**

The Federal TCA provides that: no laws or actions by any local government or planning or zoning board may prohibit, or have the effect of prohibiting, the placement, construction, or modification of communications towers, antennas, or other wireless facilities in any particular geographic area, see 47 U.S.C. §332(c)(7)(B)(i); local government or planning or zoning boards may not unreasonably discriminate among providers of functionally equivalent services, see 47 U.S.C. §332(c)(7)(B)(i); health concerns may not be considered so long as the emissions comply



with the applicable standards of the FCC, see 47 U.S.C. §332(c)(7)(B)(iv); and, decisions must be rendered within a reasonable period of time, see 47 U.S.C. §332(c)(7)(B)(ii) and the FCC's Declaratory Ruling commonly referred to as the "Shot Clock".

## CONCLUSION

DISH is committed to working cooperatively with the City of Cambridge, and all jurisdictions around the country, to secure expeditious approval of requests to install personal wireless service facilities. We respectfully request that the Board review DISH's proposed Facility and determine that the installation does not "substantially change the physical dimensions of the Base Station" pursuant to Section 6409 of the Spectrum Act, or in the alternative, to the extent necessary, grant a special permit pursuant to: Article 4, Section 4.32.g.1; Article 4, Section 4.40 (Footnote 49); and Article 10, Section 10.40 of the City of Cambridge Zoning Ordinance; Massachusetts General Laws, Ch 40A, Section 9; the TCA, all rights reserved.

DISH respectfully requests that the Board approve this Eligible Facilities Request, or in the alternative, all rights reserved, a Special Permit. Please do not hesitate to contact me should there be any questions.

Respectfully,

**BROWN RUDNICK LLP**

  
Michael R. Dolan, Esq. (SMA)





**ATTACHMENTS**

1. Application Form
2. Letter of Authorization – Notarized Owner Information Form
3. FCC Licenses
4. Photographs/Photosimulations
5. Plans
6. MPE Study
7. FCC Regulations
8. FCC Public Notice

## ADDENDUM "A"

**The Regulations provide that “substantial change” means a modification that changes the physical dimensions of an eligible support structure that meets any of the following criteria. Included below are comments in bold to demonstrate that the proposed facility is NOT a substantial change.**

For Base Stations, the modification increases the height of the structure by more than 10% or more than ten (10) feet, whichever is greater;

**As depicted on the Plans, DISH’s proposed equipment will not increase the height of the Building.**

For Base Stations, the modification involves adding an appurtenance to the body of the structure that would protrude from the edge of the structure by more than six (6) feet;

**As depicted on the Plans, DISH’s Transmission Equipment will not protrude from the edge of the Building more six (6) feet.**

For any eligible support structure, the modification involves installation of more than the standard number of new equipment cabinets for the technology involved, but not to exceed four cabinets;

**As depicted on the Plans, DISH will install two (2) cabinets as a part of this project.**

The modification entails any excavation or deployment outside the current site;

**DISH does not propose any excavation or deployment outside the current site.**

The modification would defeat the concealment elements of the tower; or

**As depicted on the Plans, DISH’s modification will be substantially similar to the existing transmission equipment on the Building and will be painted to match.**

The modification does not comply with conditions associated with the siting approval of the construction or modification of the eligible support structure or base station equipment, provided however that this limitation does not apply to any modification that is non-compliant only in a manner that would not exceed the thresholds identified in § 1.40001(b)(7)(i) through (iv).

**DISH is not aware of any noncompliance and respectfully asserts that the proposed modifications are consistent with all applicable terms of prior approvals for the wireless facility (see copies of special permits attached).**

**47 USC 1455**

**Middle Class Tax Relief and Job Creation Act of 2012**

**SEC. 6409. WIRELESS FACILITIES DEPLOYMENT**

**(a) FACILITY MODIFICATION.—**

**(1) IN GENERAL.—**Notwithstanding section 704 of the Telecommunications Act of 1996 (Public Law 104–104) or any other provision of law, a State or local government may not deny, and shall approve, any eligible facilities request for a modification of an existing wireless tower or base station that does not substantially change the physical dimensions of such tower or base station.

**(2) ELIGIBLE FACILITIES REQUEST.—**For purposes this subsection, the term “eligible facilities request” means any request for modification of an existing wireless tower or base station that involves –

- (A)** collocation of new transmission equipment;
- (B)** removal of transmission equipment; or
- (C)** replacement of transmission equipment.

**(3) APPLICABILITY OF ENVIRONMENTAL LAWS.** Nothing in paragraph (1) shall be construed to relieve the Commission from the requirements of the National Historic Preservation Act or the National Environmental Policy Act of 1969.

# Radio Frequency - Electromagnetic Energy (RF-EME) Jurisdictional Report

Site No. BOBOS00343A

1815 Massachusetts Ave  
Cambridge, Massachusetts 02140  
42° 23' 13.97" N, -71° 7' 6.96" W NAD83

EBI Project No. 6222002535  
May 2, 2022

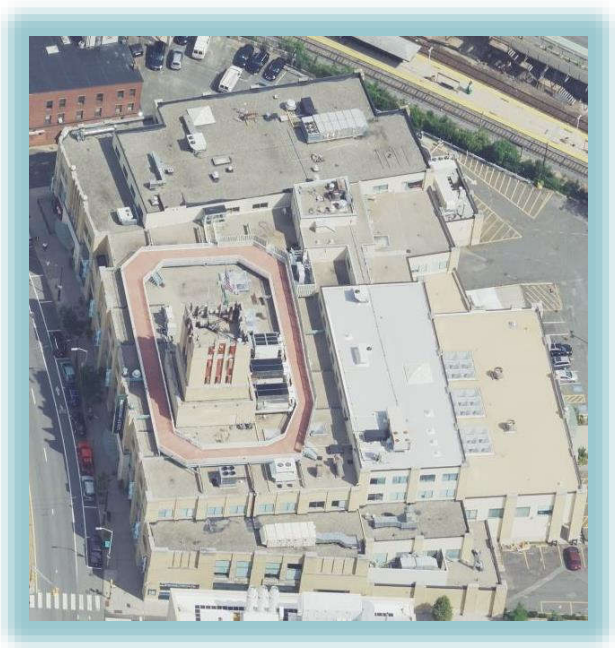

Prepared for:  
Dish Wireless

Prepared by:  
 **EBI Consulting**  
environmental | engineering | due diligence



## TABLE OF CONTENTS

<b>EXECUTIVE SUMMARY</b> .....	<b>1</b>
<b>1.0 INTRODUCTION</b> .....	<b>2</b>
<b>2.0 SITE DESCRIPTION</b> .....	<b>2</b>
<b>3.0 WORST-CASE PREDICTIVE MODELING</b> .....	<b>4</b>
<b>4.0 MITIGATION/SITE CONTROL OPTIONS</b> .....	<b>5</b>
<b>5.0 SUMMARY AND CONCLUSIONS</b> .....	<b>5</b>
<b>6.0 LIMITATIONS</b> .....	<b>6</b>

## APPENDICES

**APPENDIX A CERTIFICATIONS**

**APPENDIX B RADIO FREQUENCY ELECTROMAGNETIC ENERGY SAFETY / SIGNAGE PLANS**

**APPENDIX C FEDERAL COMMUNICATIONS COMMISSION (FCC) REQUIREMENTS**

## REFERENCE DOCUMENTS (NOT ATTACHED)

**CDs:** BOBOS00343A\_FINALSTAMPEDCDs\_20220124083000\_RF\_REVIEW\_NOTES\_20220307105723

**RFDS:** RFDS-BOBOS00343A-FINAL-20220307-v.0\_20220307105757

## EXECUTIVE SUMMARY

### Purpose of Report

EnviroBusiness Inc. (dba EBI Consulting) has been contracted by Dish Wireless to conduct radio frequency electromagnetic (RF-EME) modeling for Dish Wireless Site BOBOS00343A located at 1815 Massachusetts Ave in Cambridge, Massachusetts to determine RF-EME exposure levels from proposed Dish Wireless communications equipment at this site. As described in greater detail in Appendix C of this report, the Federal Communications Commission (FCC) has developed Maximum Permissible Exposure (MPE) Limits for the general public and for occupational activities. This report summarizes the results of RF-EME modeling in relation to relevant FCC RF-EME compliance standards for limiting human exposure to RF-EME fields.

### Statement of Compliance

A site is considered out of compliance with FCC regulations if there are areas that exceed the FCC exposure limits and there are no RF hazard mitigation measures in place. Any carrier which has an installation that contributes more than 5% of the applicable MPE must participate in mitigating these RF hazards.

As presented in the sections below, based on worst-case predictive modeling, there are no modeled areas on any accessible rooftop or ground-level walking/working surface related to the proposed antennas that exceed the FCC's occupational or general public exposure limits at this site. Additionally, there are areas where workers who may be elevated above the rooftop or ground may be exposed to power densities greater than the occupational limits. Therefore, workers should be informed about the presence and locations of antennas and their associated fields.

At the nearest walking/working surfaces to the Dish Wireless antennas, the maximum power density generated by the DISH antennas is approximately **17.51** percent of the FCC's general public limit (**3.50** percent of the FCC's occupational limit).

The composite exposure level from all carriers on this site is approximately **17.77** percent of the FCC's general public limit (**3.55** percent of the FCC's occupational limit) at the nearest walking/working surface to each antenna.

Recommended control measures are outlined in Section 4.0 and within the Site Safety Plan (attached); Dish Wireless should also provide procedures to shut down and lockout/tagout this wireless equipment in accordance with their own standard operating protocol. Non-telecom workers who will be working in areas of exceedance are required to contact Dish Wireless since only DISH has the ability to lockout/tagout the facility, or to authorize others to do so.



## 1.0 INTRODUCTION

Radio frequency waves are electromagnetic waves from the portion of the electromagnetic spectrum at frequencies lower than visible light and microwaves. The wavelengths of radio waves range from thousands of meters to around 30 centimeters. These wavelengths correspond to frequencies as low as 3 cycles per second (or hertz [Hz]) to as high as one gigahertz (one billion cycles per second).

Personal Communication (PCS) facilities used by Dish Wireless in this area will potentially operate within a frequency range of 600 to 5000 MHz. Facilities typically consist of: 1) electronic transceivers (the radios or cabinets) connected to wired telephone lines; and 2) antennas that send the wireless signals created by the transceivers to be received by individual subscriber units (PCS telephones). Transceivers are typically connected to antennas by coaxial cables.

Because of the short wavelength of PCS services, the antennas require line-of-site paths for good propagation, and are typically installed a distance above ground level. Antennas are constructed to concentrate energy towards the horizon, with as little energy as possible scattered towards the ground or the sky. This design, combined with the low power of PCS facilities, generally results in no possibility for exposure to approach Maximum Permissible Exposure (MPE) levels, with the exception of in areas in the immediate vicinity of the antennas.

MPE limits do not represent levels where a health risk exists, since they are designed to provide a substantial margin of safety. These limits apply for continuous exposures and are intended to provide a prudent margin of safety for all persons, regardless of age, gender, size or health.

## 2.0 SITE DESCRIPTION

This project site includes the following proposed wireless telecommunication antennas on a rooftop located at 1815 Massachusetts Ave in Cambridge, Massachusetts.

Ant #	Operator	Antenna Make	Antenna Model	Frequency (MHz)	Azimuth (deg.)	Mechanical Downtilt (deg.)	Horizontal Beamwidth (Degrees)	Aperture (feet)	Total Power Input (Watts)	Antenna Gain (dBd)	Total ERP (Watts)	Total EIRP (Watts)
1	Dish	JMA	MX08FRO665-21 02DT 600	600	0	0	62	6.0	120	17.45	5945.40	9750.46
1	Dish	JMA	MX08FRO665-21 04DT 1900	1900	0	0	61	6.0	160	22.65	26249.44	43049.08
1	Dish	JMA	MX08FRO665-21 04DT 2100	2100	0	0	65	6.0	160	22.65	26249.44	43049.08
2	Dish	JMA	MX08FRO665-21 02DT 600	600	120	0	62	6.0	120	17.45	5945.40	9750.46
2	Dish	JMA	MX08FRO665-21 04DT 1900	1900	120	0	61	6.0	160	22.65	26249.44	43049.08
2	Dish	JMA	MX08FRO665-21 04DT 2100	2100	120	0	65	6.0	160	22.65	26249.44	43049.08
3	Dish	JMA	MX08FRO665-21 02DT 600	600	240	0	62	6.0	120	17.45	5945.40	9750.46
3	Dish	JMA	MX08FRO665-21 04DT 1900	1900	240	0	61	6.0	160	22.65	26249.44	43049.08
3	Dish	JMA	MX08FRO665-21 04DT 2100	2100	240	0	65	6.0	160	22.65	26249.44	43049.08
4	Unknown	GENERIC	PANEL 4FT 00DT 850	850	0	0	61	4.0	100	11.52	1419.06	2327.25
5	Unknown	GENERIC	PANEL 4FT 00DT 1900	1900	0	0	65	4.0	100	14.65	2917.43	4784.58
6	Unknown	GENERIC	PANEL 4FT 00DT 850	850	0	0	61	4.0	100	11.52	1419.06	2327.25
7	Unknown	GENERIC	PANEL 4FT 00DT 850	850	120	0	61	4.0	100	11.52	1419.06	2327.25
8	Unknown	GENERIC	PANEL 4FT 00DT 1900	1900	120	0	65	4.0	100	14.65	2917.43	4784.58
9	Unknown	GENERIC	PANEL 4FT 00DT 850	850	120	0	61	4.0	100	11.52	1419.06	2327.25
10	Unknown	GENERIC	PANEL 4FT 00DT 850	850	240	0	61	4.0	100	11.52	1419.06	2327.25
11	Unknown	GENERIC	PANEL 4FT 00DT 1900	1900	240	0	65	4.0	100	14.65	2917.43	4784.58

Ant #	Operator	Antenna Make	Antenna Model	Frequency (MHz)	Azimuth (deg.)	Mechanical Downtilt (deg.)	Horizontal Beamwidth (Degrees)	Aperture (feet)	Total Power Input (Watts)	Antenna Gain (dBd)	Total ERP (Watts)	Total EIRP (Watts)
12	Unknown	GENERIC	PANEL 4FT 00DT 850	850	240	0	61	4.0	100	11.52	1419.06	2327.25
13	Unknown	GENERIC	PANEL 4FT 00DT 850	850	0	0	61	4.0	100	11.52	1419.06	2327.25
14	Unknown	GENERIC	PANEL 4FT 00DT 1900	1900	0	0	65	4.0	100	14.65	2917.43	4784.58
15	Unknown	GENERIC	PANEL 4FT 00DT 850	850	0	0	61	4.0	100	11.52	1419.06	2327.25
16	Unknown	GENERIC	PANEL 4FT 00DT 850	850	120	0	61	4.0	100	11.52	1419.06	2327.25
17	Unknown	GENERIC	PANEL 4FT 00DT 1900	1900	120	0	65	4.0	100	14.65	2917.43	4784.58
18	Unknown	GENERIC	PANEL 4FT 00DT 850	850	120	0	61	4.0	100	11.52	1419.06	2327.25
19	Unknown	GENERIC	PANEL 4FT 00DT 850	850	240	0	61	4.0	100	11.52	1419.06	2327.25
20	Unknown	GENERIC	PANEL 4FT 00DT 1900	1900	240	0	65	4.0	100	14.65	2917.43	4784.58
21	Unknown	GENERIC	PANEL 4FT 00DT 850	850	240	0	61	4.0	100	11.52	1419.06	2327.25

- Note there is 1 Dish Wireless antenna per sector at this site. For clarity, the different frequencies for each antenna are entered on separate lines.
- Gain includes antenna and combiner.

Ant #	NAME	X	Y	Antenna Radiation Centerline	Z-Height Penthouse	Z-Height Walking Track	Z-Height Main Roof	Z-Height Ground
1	Dish	25.3	11.3	63.8	-31.2	18.8	21.8	63.8
2	Dish	48.0	21.7	63.8	-31.2	18.8	21.8	63.8
3	Dish	24.2	6.5	80.0	-15.0	35.0	38.0	80.0
4	Unknown	32.8	8.1	92.0	-3.0	47.0	50.0	92.0
5	Unknown	38.4	8.1	92.0	-3.0	47.0	50.0	92.0
6	Unknown	42.6	8.3	92.0	-3.0	47.0	50.0	92.0
7	Unknown	52.2	0.4	92.0	-3.0	47.0	50.0	92.0
8	Unknown	52.2	4.8	92.0	-3.0	47.0	50.0	92.0
9	Unknown	52.0	9.8	92.0	-3.0	47.0	50.0	92.0
10	Unknown	44.0	18.8	92.0	-3.0	47.0	50.0	92.0
11	Unknown	39.7	18.8	92.0	-3.0	47.0	50.0	92.0
12	Unknown	34.0	19.0	92.0	-3.0	47.0	50.0	92.0
13	Unknown	32.8	6.7	70.0	-25.0	25.0	28.0	70.0
14	Unknown	38.4	6.5	70.0	-25.0	25.0	28.0	70.0
15	Unknown	43.0	6.9	70.0	-25.0	25.0	28.0	70.0
16	Unknown	50.7	0.2	70.0	-25.0	25.0	28.0	70.0
17	Unknown	50.5	5.0	70.0	-25.0	25.0	28.0	70.0
18	Unknown	50.7	10.2	70.0	-25.0	25.0	28.0	70.0
19	Unknown	44.2	17.5	70.0	-25.0	25.0	28.0	70.0
20	Unknown	39.9	17.1	70.0	-25.0	25.0	28.0	70.0
21	Unknown	34.2	17.9	70.0	-25.0	25.0	28.0	70.0

- Note the Z-Height represents the distance from the antenna centerline in feet.

The above tables contain an inventory of proposed Dish Wireless antennas and other carrier antennas if sufficient information was available to model them. Note that EBI uses an assumed set of antenna specifications and powers for unknown and other carrier antennas for modeling purposes. The FCC guidelines incorporate two separate tiers of exposure limits that are based upon occupational/controlled



exposure limits (for workers) and general population/uncontrolled exposure limits for members of the general public that may be exposed to antenna fields. While access to this site is considered uncontrolled, the analysis has considered exposures with respect to both controlled and uncontrolled limits as an untrained worker may access adjacent rooftop locations. Additional information regarding controlled/uncontrolled exposure limits is provided in Appendix C. Appendix B presents a site safety plan that provides a plan view of the rooftop with antenna locations.

### **3.0 WORST-CASE PREDICTIVE MODELING**

EBI has performed theoretical MPE modeling using RoofMaster™ software to estimate the worst-case power density at the site's nearby broadcast levels resulting from operation of the antennas. RoofMaster™ is a widely-used predictive modeling program that has been developed by Waterford Consultants to predict RF power density values for rooftop and tower telecommunications sites produced by vertical collinear antennas that are typically used in the cellular, PCS, paging and other communications services. Using the computational methods set forth in Federal Communications Commission (FCC) Office of Engineering & Technology (OET) Bulletin 65, "Evaluating Compliance with FCC Guidelines for Human Exposure to Radiofrequency Electromagnetic Fields" (OET-65), RoofMaster™ calculates predicted power density in a scalable grid based on the contributions of all RF sources characterized in the study scenario. At each grid location, the cumulative power density is expressed as a percentage of the FCC limits. Manufacturer antenna pattern data is utilized in these calculations. RoofMaster™ models consist of the Far Field model as specified in OET-65 and an implementation of the OET-65 Cylindrical Model (Sula9). The models utilize several operational specifications for different types of antennas to produce a plot of spatially-averaged power densities that can be expressed as a percentage of the applicable exposure limit.

For this report, EBI utilized antenna and power data provided by Dish Wireless and compared the resultant worst-case MPE levels to the FCC's occupational/controlled exposure limits outlined in OET Bulletin 65. The assumptions used in the modeling are based upon information provided by Dish Wireless and information gathered from other sources. Elevations of walking/working surfaces were estimated based on elevations provided and available aerial imagery. Sector orientation assignments were made assuming coverage is directed to areas of site. Changes to antenna mount heights or placement will impact site compliance. The parameters used for modeling are summarized in the Site Description antenna inventory table in Section 2.0.

Unknown Carriers also have antennas on the rooftop. Information about these antennas was included in the modeling analysis.

Based on worst-case predictive modeling, there are no modeled areas on any accessible rooftop or ground-level walking/working surface related to the proposed Dish Wireless antennas that exceed the FCC's occupational or general public exposure limits at this site. At the nearest walking/working surfaces to the Dish Wireless antennas, the maximum power density generated by the Dish Wireless antennas is approximately 17.51 percent of the FCC's general public limit (3.50 percent of the FCC's occupational limit). The composite exposure level from all carriers on this site is approximately 17.77 percent of the FCC's general public limit (3.55 percent of the FCC's occupational limit) at the nearest walking/working surface to each antenna.

The Site Safety Plan also presents areas where Dish Wireless antennas contribute greater than 5% of the applicable MPE limit for a site. A site is considered out of compliance with FCC regulations if there are areas that exceed the FCC exposure limits and there are no RF hazard mitigation measures in place. Any carrier which has an installation that contributes more than 5% of the applicable MPE must participate in mitigating these RF hazards.

There are no modeled areas on the rooftop and ground that exceed the FCC's limits for general public or occupational exposure in front of the other carrier antennas.

The inputs used in the modeling are summarized in the Site Description antenna inventory table in Section 2.0. A graphical representation of the RoofMaster™ modeling results is presented in Appendix B. Microwave dish antennas are designed for point-to-point operations at the elevations of the installed equipment rather than ground level coverage. The maximum power density generated by all carrier antennas, including microwaves and panel antennas, is included in the modeling results presented within this report.

#### **4.0 MITIGATION/SITE CONTROL OPTIONS**

EBI's modeling indicates that there are no areas in front of the Dish Wireless antennas that exceed the FCC standards for occupational or general public exposure. All exposures above the FCC's safe limits require that individuals be elevated above the rooftop and/or ground. In order to alert people accessing the rooftop, a Guidelines sign and an NOC Information sign are recommended for installation at each access point to the rooftop. Additionally, Blue Notice signs are recommended for installation on the penthouse wall next to the Dish Wireless Sector A, B, and C antennas. These signs must be placed in a conspicuous manner so that they are visible to any person approaching the antennas from any direction.

Barriers are recommended for installation when possible to block access to the areas in front of the antennas that exceed the FCC general public and/or occupational limits. Barriers may consist of rope, chain, or fencing. Painted stripes should only be used as a last resort. There are no barriers recommended on this site. Barriers are not recommended for installation because exceedances are into free space over lower walking/working surfaces. There are no exceedances on any rooftop and/or ground walking/working surface.

These protocols and recommended control measures have been summarized and included with a graphic representation of the antennas and associated signage and control areas in a RF-EME Site Safety Plan, which is included as Appendix B. Individuals and workers accessing the rooftop should be provided with a copy of the attached Site Safety Plan, made aware of the posted signage, and signify their understanding of the Site Safety Plan.

To reduce the risk of exposure, EBI recommends that access to areas associated with the active antenna installation be restricted and secured where possible.

Implementation of the signage recommended in the Site Safety Plan and in this report will bring this site into compliance with the FCC's rules and regulations.

#### **5.0 SUMMARY AND CONCLUSIONS**

EBI has prepared a Radiofrequency – Electromagnetic Energy (RF-EME) Compliance Report for telecommunications equipment installed by Dish Wireless Site Number BOBOS00343A located at 1815 Massachusetts Ave in Cambridge, Massachusetts to determine worst-case predicted RF-EME exposure levels from wireless communications equipment installed at this site. This report summarizes the results of RF-EME modeling in relation to relevant Federal Communications Commission (FCC) RF-EME compliance standards for limiting human exposure to RF-EME fields.

As presented in the sections above, based on the FCC criteria, there are no modeled areas on any accessible rooftop or ground-level walking/working surface related to the proposed antennas that exceed the FCC's occupational or general public exposure limits at this site.

Workers should be informed about the presence and locations of antennas and their associated fields. Recommended control measures are outlined in Section 4.0 and within the Site Safety Plan (attached);



Dish Wireless should also provide procedures to shut down and lockout/tagout this wireless equipment in accordance with their own standard operating protocol. Non-telecom workers who will be working in areas of exceedance are required to contact Dish Wireless since only Dish Wireless has the ability to lockout/tagout the facility, or to authorize others to do so.

## **6.0 LIMITATIONS**

This report was prepared for the use of Dish Wireless. It was performed in accordance with generally accepted practices of other consultants undertaking similar studies at the same time and in the same locale under like circumstances. The conclusions provided by EBI are based solely on the information provided by the client. The observations in this report are valid on the date of the investigation. Any additional information that becomes available concerning the site should be provided to EBI so that our conclusions may be revised and modified, if necessary. This report has been prepared in accordance with Standard Conditions for Engagement and authorized proposal, both of which are integral parts of this report. No other warranty, expressed or implied, is made.

# **Appendix A**

## **Certifications**



## Preparer Certification

I, David Keirstead, state that:

- I am an employee of EnviroBusiness Inc. (d/b/a EBI Consulting), which provides RF-EME safety and compliance services to the wireless communications industry.
- I have successfully completed RF-EME safety training, and I am aware of the potential hazards from RF-EME and would be classified “occupational” under the FCC regulations.
- I am fully aware of and familiar with the Rules and Regulations of both the Federal Communications Commissions (FCC) and the Occupational Safety and Health Administration (OSHA) with regard to Human Exposure to Radio Frequency Radiation.
- I have reviewed the data provided by the client and incorporated it into this Site Compliance Report such that the information contained in this report is true and accurate to the best of my knowledge.

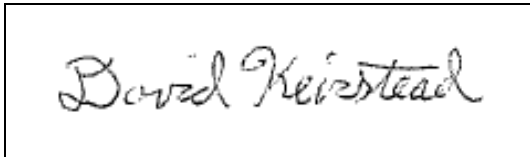

David Keirstead

Reviewed and Approved by:

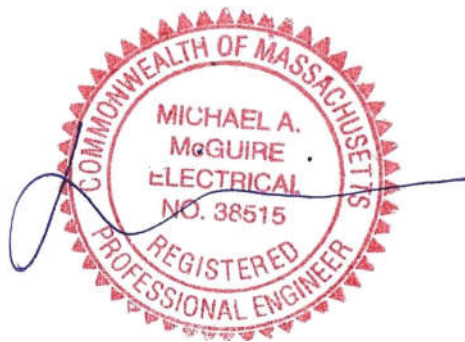

sealed 2may2022 mike@h2dc.com  
H2DC PLLC MA CoA#: 001239603

---

Michael McGuire  
Electrical Engineer  
[mike@h2dc.com](mailto:mike@h2dc.com)

Note that EBI's scope of work is limited to an evaluation of the Radio Frequency – Electromagnetic Energy (RF-EME) field generated by the antennas and broadcast equipment noted in this report. The engineering and design of the building and related structures, as well as the impact of the antennas and broadcast equipment on the structural integrity of the building, are specifically excluded from EBI's scope of work.



**Appendix B**

**Radio Frequency Electromagnetic Energy**

**Safety Information and Signage Plans**

### Nearest Walking Surface (Walking Track Level) Simulation

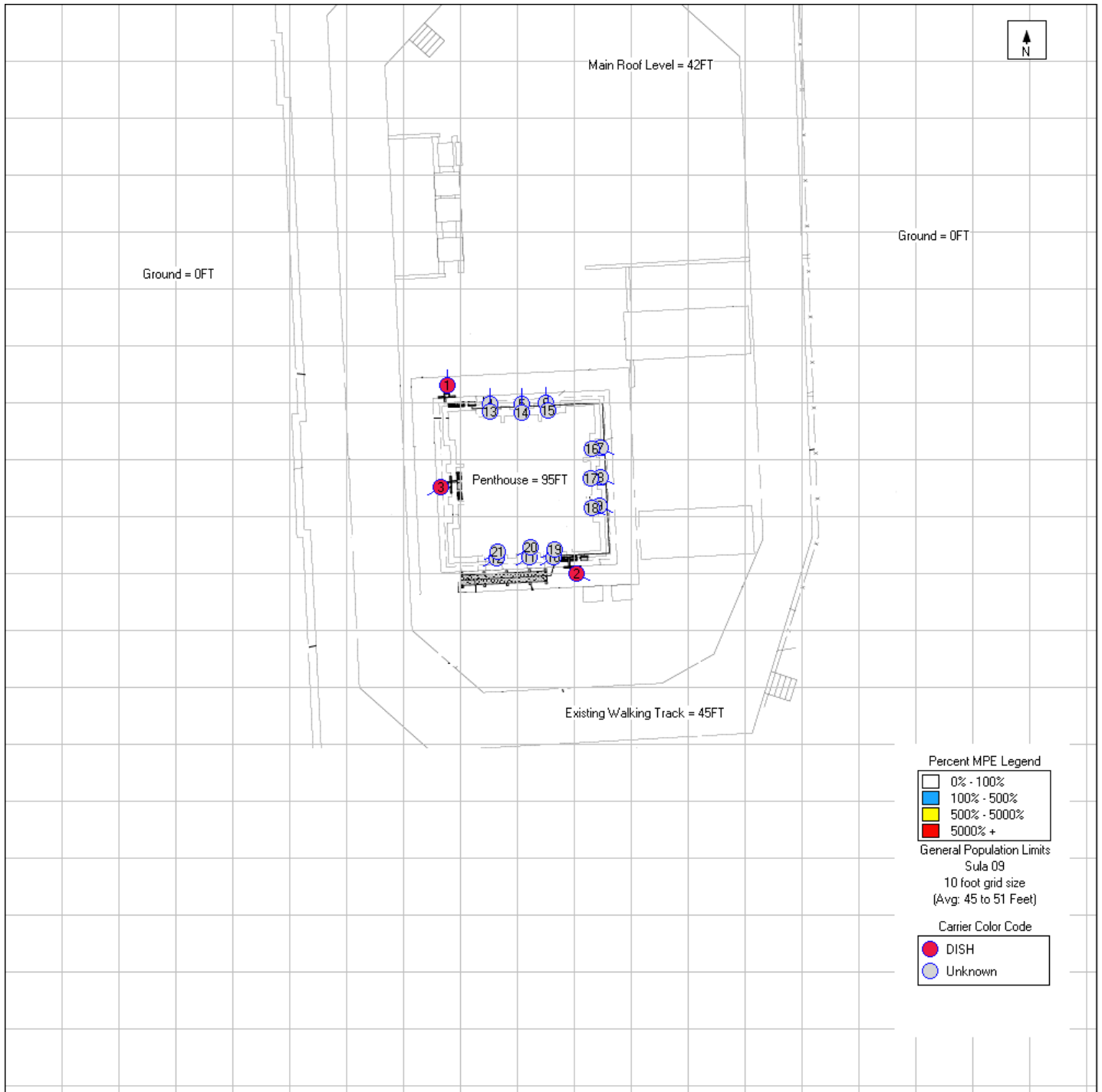



### Main Roof Level Simulation

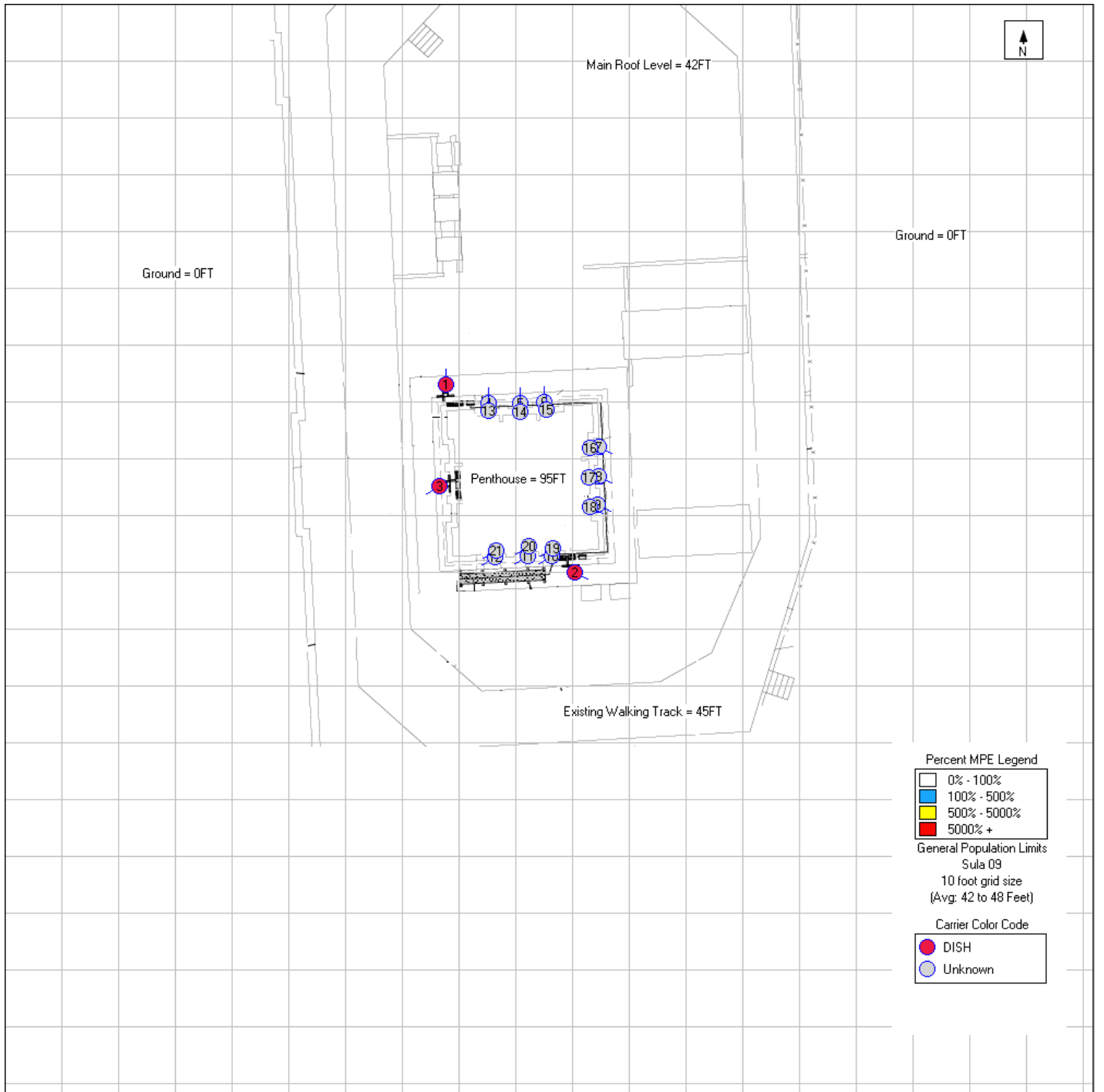

### Ground Level Simulation

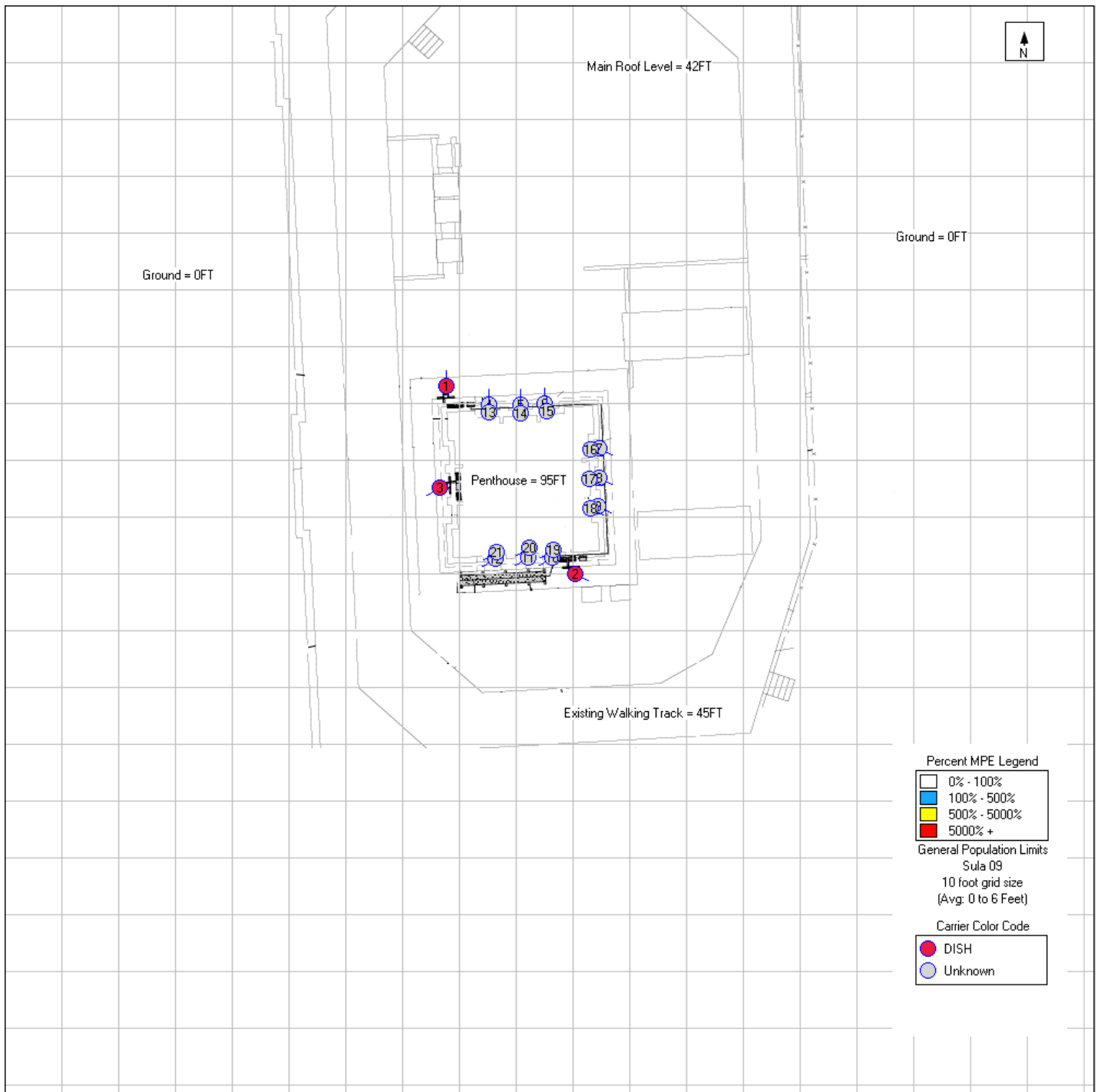



## Dish Wireless Safety (Signage) Plan

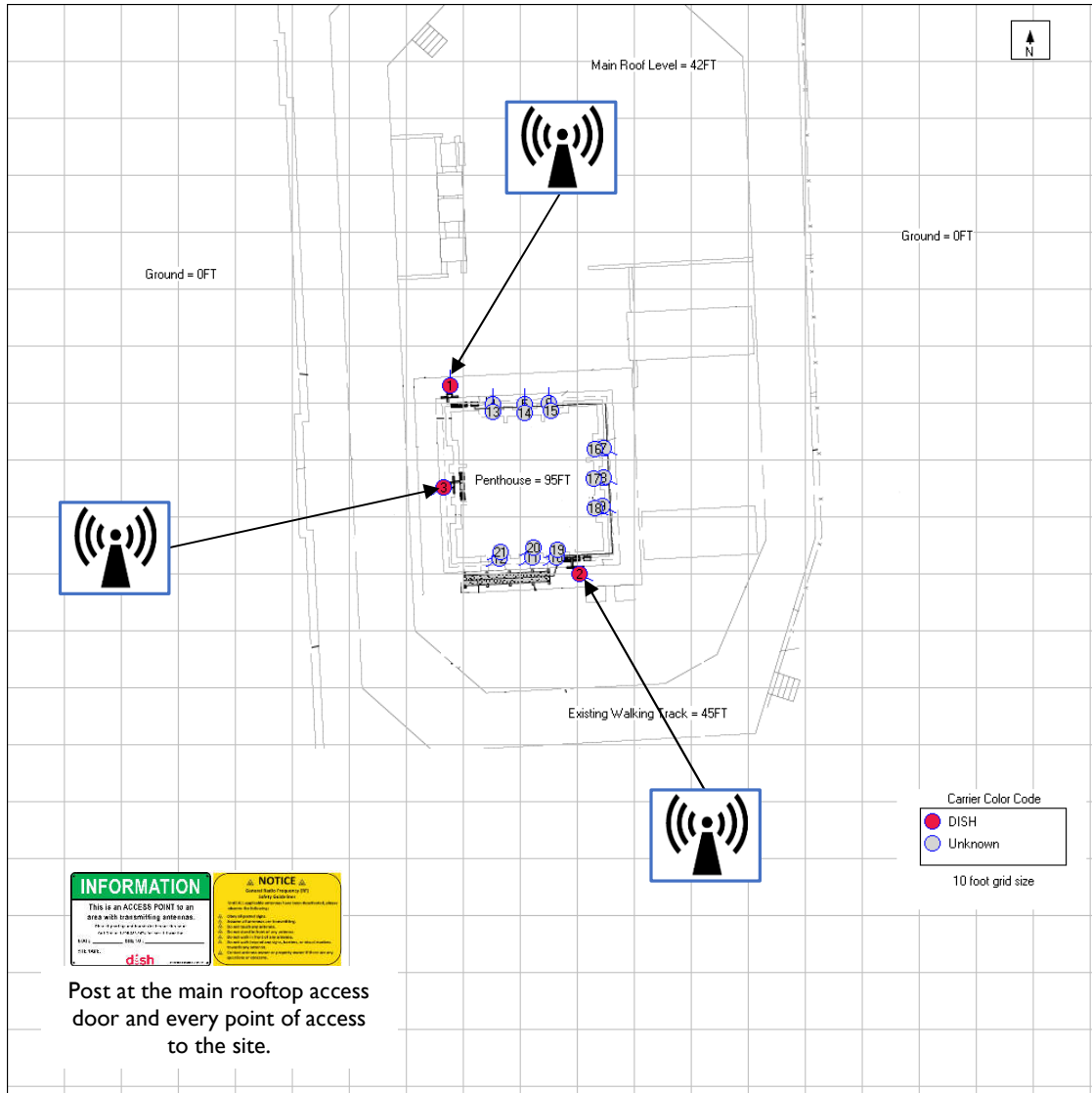

Sign	Posting Instructions	Required Signage / Mitigation
 <b>INFORMATION</b> <small>This is an ACCESS POINT to an area with transmitting antennas.</small> 	<b>NOC Information</b> Information signs are used to provide contact information for any questions or concerns for personnel accessing the site.	Securely post at the main rooftop access door and every point of access to the site in a manner conspicuous to all individuals entering thereon as indicated in the signage plan.
 <b>NOTICE</b> <small>This is an ACCESS POINT to an area with transmitting antennas.</small>	<b>Guidelines</b> Informational sign used to notify workers that there are active antennas installed and provide guidelines for working in RF environments.	Securely post at the main rooftop access door and every point of access to the site in a manner conspicuous to all individuals entering thereon as indicated in the signage plan.
 <b>Warning</b>	<b>Notice</b> Used to notify individuals they are entering an area where the power density emitted from transmitting antennas may exceed the FCC's MPE limit for the general public or occupational exposures.	Securely post on the penthouse wall next to the Dish Wireless Sector A, B, and C antennas.
 <b>Caution</b>	<b>Caution</b> Used to notify individuals that they are entering a hot spot where either the general public or occupational FCC's MPE limit is or could be exceeded.	No Signage Required
 <b>Warning</b>	<b>Warning</b> Used to notify individuals that they are entering a hot zone where the occupational FCC's MPE limit has been exceeded by 10x.	No Signage Required

# **Appendix C**

## **Federal Communications Commission (FCC) Requirements**



The FCC has established Maximum Permissible Exposure (MPE) limits for human exposure to Radiofrequency Electromagnetic (RF-EME) energy fields, based on exposure limits recommended by the National Council on Radiation Protection and Measurements (NCRP) and, over a wide range of frequencies, the exposure limits developed by the Institute of Electrical and Electronics Engineers, Inc. (IEEE) and adopted by the American National Standards Institute (ANSI) to replace the 1982 ANSI guidelines. Limits for localized absorption are based on recommendations of both ANSI/IEEE and NCRP.

The FCC guidelines incorporate two separate tiers of exposure limits that are based upon occupational/controlled exposure limits (for workers) and general public/uncontrolled exposure limits for members of the general public.

**Occupational/controlled exposure limits** apply to situations in which persons are exposed as a consequence of their employment and in which those persons who are exposed have been made fully aware of the potential for exposure and can exercise control over their exposure. Occupational/controlled exposure limits also apply where exposure is of a transient nature as a result of incidental passage through a location where exposure levels may be above general public/uncontrolled limits (see below), as long as the exposed person has been made fully aware of the potential for exposure and can exercise control over his or her exposure by leaving the area or by some other appropriate means.

**General public/uncontrolled exposure limits** apply to situations in which the general public may be exposed or in which persons who are exposed as a consequence of their employment may not be made fully aware of the potential for exposure or cannot exercise control over their exposure. Therefore, members of the general public would always be considered under this category when exposure is not employment-related, for example, in the case of a telecommunications tower that exposes persons in a nearby residential area.

Table I and Figure I (below), which are included within the FCC's OET Bulletin 65, summarize the MPE limits for RF emissions. These limits are designed to provide a substantial margin of safety. They vary by frequency to take into account the different types of equipment that may be in operation at a particular facility and are "time-averaged" limits to reflect different durations resulting from controlled and uncontrolled exposures.

The FCC's MPEs are measured in terms of power (mW) over a unit surface area (cm<sup>2</sup>). Known as the power density, the FCC has established an occupational MPE of 5 milliwatts per square centimeter (mW/cm<sup>2</sup>) and an uncontrolled MPE of 1 mW/cm<sup>2</sup> for equipment operating in the 1900 MHz frequency range. For the Dish Wireless equipment operating at 600 MHz or 850 MHz, the FCC's occupational MPE is 2.83 mW/cm<sup>2</sup> and an uncontrolled MPE of 0.57 mW/cm<sup>2</sup>. For the Dish Wireless equipment operating at 1900 MHz, the FCC's occupational MPE is 5.0 mW/cm<sup>2</sup> and an uncontrolled MPE limit of 1.0 mW/cm<sup>2</sup>. These limits are considered protective of these populations.

Table I: Limits for Maximum Permissible Exposure (MPE)				
(A) Limits for Occupational/Controlled Exposure				
Frequency Range (MHz)	Electric Field Strength (E) (V/m)	Magnetic Field Strength (H) (A/m)	Power Density (S) (mW/cm <sup>2</sup> )	Averaging Time [E] <sup>2</sup> , [H] <sup>2</sup> , or S (minutes)
0.3-3.0	614	1.63	(100)*	6
3.0-30	1842/f	4.89/f	(900/f <sup>2</sup> )*	6
30-300	61.4	0.163	1.0	6
300-1,500	--	--	f/300	6
1,500-100,000	--	--	5	6
(B) Limits for General Public/Uncontrolled Exposure				
Frequency Range (MHz)	Electric Field Strength (E) (V/m)	Magnetic Field Strength (H) (A/m)	Power Density (S) (mW/cm <sup>2</sup> )	Averaging Time [E] <sup>2</sup> , [H] <sup>2</sup> , or S (minutes)
0.3-1.34	614	1.63	(100)*	30
1.34-30	824/f	2.19/f	(180/f <sup>2</sup> )*	30
30-300	27.5	0.073	0.2	30
300-1,500	--	--	f/1,500	30
1,500-100,000	--	--	1.0	30

f = Frequency in (MHz)  
 \* Plane-wave equivalent power density

Figure 1. FCC Limits for Maximum Permissible Exposure (MPE)  
 Plane-wave Equivalent Power Density

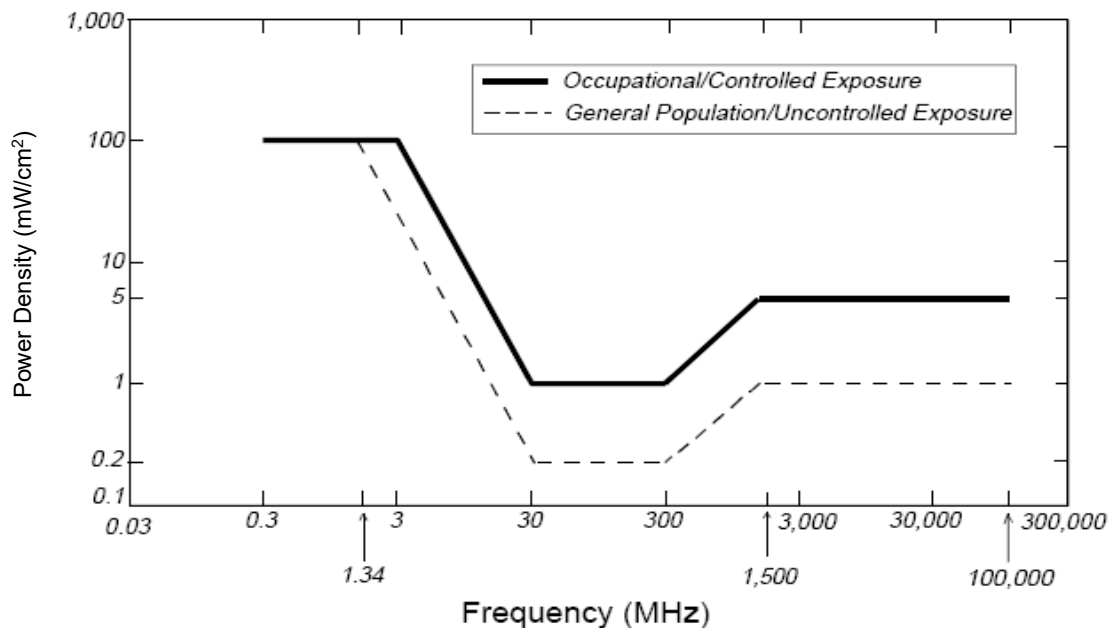

Based on the above, the most restrictive thresholds for exposures of unlimited duration to RF energy for several personal wireless services are summarized below:

Personal Wireless Service	Approximate Frequency	Occupational MPE	Public MPE
Microwave (Point-to-Point)	5,000 - 80,000 MHz	5.00 mW/cm <sup>2</sup>	1.00 mW/cm <sup>2</sup>
Broadband Radio (BRS)	2,600 MHz	5.00 mW/cm <sup>2</sup>	1.00 mW/cm <sup>2</sup>
Wireless Communication (WCS)	2,300 MHz	5.00 mW/cm <sup>2</sup>	1.00 mW/cm <sup>2</sup>
Advanced Wireless (AWS)	2,100 MHz	5.00 mW/cm <sup>2</sup>	1.00 mW/cm <sup>2</sup>
Personal Communication (PCS)	1,950 MHz	5.00 mW/cm <sup>2</sup>	1.00 mW/cm <sup>2</sup>
Cellular Telephone	870 MHz	2.90 mW/cm <sup>2</sup>	0.58 mW/cm <sup>2</sup>
Specialized Mobile Radio (SMR)	855 MHz	2.85 mW/cm <sup>2</sup>	0.57 mW/cm <sup>2</sup>
Long Term Evolution (LTE)	700 MHz	2.33 mW/cm <sup>2</sup>	0.47 mW/cm <sup>2</sup>
Most Restrictive Frequency Range	30-300 MHz	1.00 mW/cm <sup>2</sup>	0.20 mW/cm <sup>2</sup>

MPE limits are designed to provide a substantial margin of safety. These limits apply for continuous exposures and are intended to provide a prudent margin of safety for all persons, regardless of age, gender, size, or health.

Personal Communication (PCS) facilities used by Dish Wireless in this area will potentially operate within a frequency range of 600 to 2100 MHz. Facilities typically consist of: 1) electronic transceivers (the radios or cabinets) connected to wired telephone lines; and 2) antennas that send the wireless signals created by the transceivers to be received by individual subscriber units (PCS telephones). Transceivers are typically connected to antennas by coaxial cables.

Because of the short wavelength of PCS services, the antennas require line-of-site paths for good propagation, and are typically installed above ground level. Antennas are constructed to concentrate energy towards the horizon, with as little energy as possible scattered towards the ground or the sky. This design, combined with the low power of PCS facilities, generally results in no possibility for exposure to approach Maximum Permissible Exposure (MPE) levels, with the exception of areas directly in front of the antennas.

### FCC Compliance Requirement

A site is considered out of compliance with FCC regulations if there are areas that exceed the FCC exposure limits and there are no RF hazard mitigation measures in place. Any carrier which has an installation that contributes more than 5% of the applicable MPE must participate in mitigating these RF hazards.



## **Subpart U—State and Local Government Regulation of the Placement, Construction, and Modification of Personal Wireless Service Facilities**

### **Contents**

#### **§1.6001 Purpose.**

#### **§1.6002 Definitions.**

#### **§1.6003 Reasonable periods of time to act on siting applications.**

#### **§1.6100 Wireless Facility Modifications.**

Source: 83 FR 51884, Oct. 15, 2018, unless otherwise noted.

#### **§1.6001 Purpose.**

This subpart implements 47 U.S.C. 332(c)(7) and 1455.

#### **§1.6002 Definitions.**

Terms not specifically defined in this section or elsewhere in this subpart have the meanings defined in this part and the Communications Act of 1934, 47 U.S.C. 151 et seq. Terms used in this subpart have the following meanings:

(a) *Action* or *to act* on a siting application means a siting authority's grant of a siting application or issuance of a written decision denying a siting application.

(b) *Antenna*, consistent with §1.1320(d), means an apparatus designed for the purpose of emitting radiofrequency (RF) radiation, to be operated or operating from a fixed location pursuant to Commission authorization, for the provision of personal wireless service and any commingled information services. For purposes of this definition, the term antenna does not include an unintentional radiator, mobile station, or device authorized under part 15 of this chapter.

(c) *Antenna equipment*, consistent with §1.1320(d), means equipment, switches, wiring, cabling, power sources, shelters or cabinets associated with an antenna, located at the same fixed location as the antenna, and, when collocated on a structure, is mounted or installed at the same time as such antenna.

(d) *Antenna facility* means an antenna and associated antenna equipment.

(e) *Applicant* means a person or entity that submits a siting application and the agents, employees, and contractors of such person or entity.

(f) *Authorization* means any approval that a siting authority must issue under applicable law prior to the deployment of personal wireless service facilities, including, but not limited to, zoning approval and building permit.

(g) *Collocation*, consistent with §1.1320(d) and the Nationwide Programmatic Agreement (NPA) for the Collocation of Wireless Antennas, appendix B of this part, section I.B, means—

(1) Mounting or installing an antenna facility on a pre-existing structure; and/or

(2) Modifying a structure for the purpose of mounting or installing an antenna facility on that structure.

(3) The definition of “collocation” in §1.6100(b)(2) applies to the term as used in that section.

(h) *Deployment* means placement, construction, or modification of a personal wireless service facility.

(i) *Facility or personal wireless service facility* means an antenna facility or a structure that is used for the provision of personal wireless service, whether such service is provided on a stand-alone basis or commingled with other wireless communications services.

(j) *Siting application or application* means a written submission to a siting authority requesting authorization for the deployment of a personal wireless service facility at a specified location.

(k) *Siting authority* means a State government, local government, or instrumentality of a State government or local government, including any official or organizational unit thereof, whose authorization is necessary prior to the deployment of personal wireless service facilities.

(l) *Small wireless facilities*, consistent with §1.1312(e)(2), are facilities that meet each of the following conditions:

(1) The facilities—

(i) Are mounted on structures 50 feet or less in height including their antennas as defined in §1.1320(d); or

(ii) Are mounted on structures no more than 10 percent taller than other adjacent structures; or

(iii) Do not extend existing structures on which they are located to a height of more than 50 feet or by more than 10 percent, whichever is greater;

- (2) Each antenna associated with the deployment, excluding associated antenna equipment (as defined in the definition of “antenna” in §1.1320(d)), is no more than three cubic feet in volume;
- (3) All other wireless equipment associated with the structure, including the wireless equipment associated with the antenna and any pre-existing associated equipment on the structure, is no more than 28 cubic feet in volume;
- (4) The facilities do not require antenna structure registration under part 17 of this chapter;
- (5) The facilities are not located on Tribal lands, as defined under 36 CFR 800.16(x); and
- (6) The facilities do not result in human exposure to radiofrequency radiation in excess of the applicable safety standards specified in §1.1307(b).

(m) Structure means a pole, tower, base station, or other building, whether or not it has an existing antenna facility, that is used or to be used for the provision of personal wireless service (whether on its own or comingled with other types of services).

### **§1.6003 Reasonable periods of time to act on siting applications.**

(a) *Timely action required.* A siting authority that fails to act on a siting application on or before the shot clock date for the application, as defined in paragraph (e) of this section, is presumed not to have acted within a reasonable period of time.

(b) *Shot clock period.* The shot clock period for a siting application is the sum of—

- (1) The number of days of the presumptively reasonable period of time for the pertinent type of application, pursuant to paragraph (c) of this section; plus
- (2) The number of days of the tolling period, if any, pursuant to paragraph (d) of this section.

(c) *Presumptively reasonable periods of time—*

(1) *Review periods for individual applications.* The following are the presumptively reasonable periods of time for action on applications seeking authorization for deployments in the categories set forth in paragraphs (c)(1)(i) through (iv) of this section:

- (i) Review of an application to collocate a Small Wireless Facility using an existing structure: 60 days.



(ii) Review of an application to collocate a facility other than a Small Wireless Facility using an existing structure: 90 days.

(iii) Review of an application to deploy a Small Wireless Facility using a new structure: 90 days.

(iv) Review of an application to deploy a facility other than a Small Wireless Facility using a new structure: 150 days.

(2) *Batching.*

(i) If a single application seeks authorization for multiple deployments, all of which fall within a category set forth in either paragraph (c)(1)(i) or (iii) of this section, then the presumptively reasonable period of time for the application as a whole is equal to that for a single deployment within that category.

(ii) If a single application seeks authorization for multiple deployments, the components of which are a mix of deployments that fall within paragraph (c)(1)(i) of this section and deployments that fall within paragraph (c)(1)(iii) of this section, then the presumptively reasonable period of time for the application as a whole is 90 days.

(iii) Siting authorities may not refuse to accept applications under paragraphs (c)(2)(i) and (ii) of this section.

(d) *Tolling period.* Unless a written agreement between the applicant and the siting authority provides otherwise, the tolling period for an application (if any) is as set forth in paragraphs (d)(1) through (3) of this section.

(1) For an initial application to deploy Small Wireless Facilities, if the siting authority notifies the applicant on or before the 10th day after submission that the application is materially incomplete, and clearly and specifically identifies the missing documents or information and the specific rule or regulation creating the obligation to submit such documents or information, the shot clock date calculation shall restart at zero on the date on which the applicant submits all the documents and information identified by the siting authority to render the application complete.

(2) For all other initial applications, the tolling period shall be the number of days from—

(i) The day after the date when the siting authority notifies the applicant in writing that the application is materially incomplete and clearly and specifically identifies the missing documents or information that the applicant must submit to render the application complete and the specific rule or regulation creating this obligation; until

(ii) The date when the applicant submits all the documents and information identified by the siting authority to render the application complete;

(iii) But only if the notice pursuant to paragraph (d)(2)(i) of this section is effectuated on or before the 30th day after the date when the application was submitted; or

(3) For resubmitted applications following a notice of deficiency, the tolling period shall be the number of days from—

(i) The day after the date when the siting authority notifies the applicant in writing that the applicant's supplemental submission was not sufficient to render the application complete and clearly and specifically identifies the missing documents or information that need to be submitted based on the siting authority's original request under paragraph (d)(1) or (2) of this section; until

(ii) The date when the applicant submits all the documents and information identified by the siting authority to render the application complete;

(iii) But only if the notice pursuant to paragraph (d)(3)(i) of this section is effectuated on or before the 10th day after the date when the applicant makes a supplemental submission in response to the siting authority's request under paragraph (d)(1) or (2) of this section.

(e) *Shot clock date.* The shot clock date for a siting application is determined by counting forward, beginning on the day after the date when the application was submitted, by the number of calendar days of the shot clock period identified pursuant to paragraph (b) of this section and including any pre-application period asserted by the siting authority; provided, that if the date calculated in this manner is a “holiday” as defined in §1.4(e)(1) or a legal holiday within the relevant State or local jurisdiction, the shot clock date is the next business day after such date. The term “business day” means any day as defined in §1.4(e)(2) and any day that is not a legal holiday as defined by the State or local jurisdiction.

#### **§1.6100 Wireless Facility Modifications.**

(a) [Reserved]

(b) *Definitions.* Terms used in this section have the following meanings.

(1) *Base station.* A structure or equipment at a fixed location that enables Commission-licensed or authorized wireless communications between user equipment and a communications network. The term does not encompass a tower as defined in this subpart or any equipment associated with a tower.

(i) The term includes, but is not limited to, equipment associated with wireless communications services such as private, broadcast, and public safety services, as well as unlicensed wireless services and fixed wireless services such as microwave backhaul.

(ii) The term includes, but is not limited to, radio transceivers, antennas, coaxial or fiber-optic cable, regular and backup power supplies, and comparable equipment, regardless of technological configuration (including Distributed Antenna Systems and small-cell networks).

(iii) The term includes any structure other than a tower that, at the time the relevant application is filed with the State or local government under this section, supports or houses equipment described in paragraphs (b)(1)(i) through (ii) of this section that has been reviewed and approved under the applicable zoning or siting process, or under another State or local regulatory review process, even if the structure was not built for the sole or primary purpose of providing such support.

(iv) The term does not include any structure that, at the time the relevant application is filed with the State or local government under this section, does not support or house equipment described in paragraphs (b)(1)(i)-(ii) of this section.

(2) *Collocation*. The mounting or installation of transmission equipment on an eligible support structure for the purpose of transmitting and/or receiving radio frequency signals for communications purposes.

(3) *Eligible facilities request*. Any request for modification of an existing tower or base station that does not substantially change the physical dimensions of such tower or base station, involving:

(i) Collocation of new transmission equipment;

(ii) Removal of transmission equipment; or

(iii) Replacement of transmission equipment.

(4) *Eligible support structure*. Any tower or base station as defined in this section, provided that it is existing at the time the relevant application is filed with the State or local government under this section.

(5) *Existing*. A constructed tower or base station is existing for purposes of this section if it has been reviewed and approved under the applicable zoning or siting process, or under another State or local regulatory review process, provided that a tower that has not been reviewed and approved because it was not in a zoned area when it was built, but was lawfully constructed, is existing for purposes of this definition.



(6) *Site*. For towers other than towers in the public rights-of-way, the current boundaries of the leased or owned property surrounding the tower and any access or utility easements currently related to the site, and, for other eligible support structures, further restricted to that area in proximity to the structure and to other transmission equipment already deployed on the ground. The current boundaries of a site are the boundaries that existed as of the date that the original support structure or a modification to that structure was last reviewed and approved by a State or local government, if the approval of the modification occurred prior to the Spectrum Act or otherwise outside of the section 6409(a) process.

(7) *Substantial change*. A modification substantially changes the physical dimensions of an eligible support structure if it meets any of the following criteria:

(i) For towers other than towers in the public rights-of-way, it increases the height of the tower by more than 10% or by the height of one additional antenna array with separation from the nearest existing antenna not to exceed twenty feet, whichever is greater; for other eligible support structures, it increases the height of the structure by more than 10% or more than ten feet, whichever is greater;

(A) Changes in height should be measured from the original support structure in cases where deployments are or will be separated horizontally, such as on buildings' rooftops; in other circumstances, changes in height should be measured from the dimensions of the tower or base station, inclusive of originally approved appurtenances and any modifications that were approved prior to the passage of the Spectrum Act.

(ii) For towers other than towers in the public rights-of-way, it involves adding an appurtenance to the body of the tower that would protrude from the edge of the tower more than twenty feet, or more than the width of the tower structure at the level of the appurtenance, whichever is greater; for other eligible support structures, it involves adding an appurtenance to the body of the structure that would protrude from the edge of the structure by more than six feet;

(iii) For any eligible support structure, it involves installation of more than the standard number of new equipment cabinets for the technology involved, but not to exceed four cabinets; or, for towers in the public rights-of-way and base stations, it involves installation of any new equipment cabinets on the ground if there are no pre-existing ground cabinets associated with the structure, or else involves installation of ground cabinets that are more than 10% larger in height or overall volume than any other ground cabinets associated with the structure;

(iv) It entails any excavation or deployment outside of the current site, except that, for towers other than towers in the public rights-of-way, it entails any excavation or deployment of transmission equipment outside of the current site by more than 30 feet in any direction. The site

boundary from which the 30 feet is measured excludes any access or utility easements currently related to the site;

(v) It would defeat the concealment elements of the eligible support structure; or

(vi) It does not comply with conditions associated with the siting approval of the construction or modification of the eligible support structure or base station equipment, provided however that this limitation does not apply to any modification that is non-compliant only in a manner that would not exceed the thresholds identified in §1.40001(b)(7)(i) through (iv).

(8) *Transmission equipment.* Equipment that facilitates transmission for any Commission-licensed or authorized wireless communication service, including, but not limited to, radio transceivers, antennas, coaxial or fiber-optic cable, and regular and backup power supply. The term includes equipment associated with wireless communications services including, but not limited to, private, broadcast, and public safety services, as well as unlicensed wireless services and fixed wireless services such as microwave backhaul.

(9) *Tower.* Any structure built for the sole or primary purpose of supporting any Commission-licensed or authorized antennas and their associated facilities, including structures that are constructed for wireless communications services including, but not limited to, private, broadcast, and public safety services, as well as unlicensed wireless services and fixed wireless services such as microwave backhaul, and the associated site.

(c) *Review of applications.* A State or local government may not deny and shall approve any eligible facilities request for modification of an eligible support structure that does not substantially change the physical dimensions of such structure.

(1) *Documentation requirement for review.* When an applicant asserts in writing that a request for modification is covered by this section, a State or local government may require the applicant to provide documentation or information only to the extent reasonably related to determining whether the request meets the requirements of this section. A State or local government may not require an applicant to submit any other documentation, including but not limited to documentation intended to illustrate the need for such wireless facilities or to justify the business decision to modify such wireless facilities.

(2) *Timeframe for review.* Within 60 days of the date on which an applicant submits a request seeking approval under this section, the State or local government shall approve the application unless it determines that the application is not covered by this section.

(3) *Tolling of the timeframe for review.* The 60-day period begins to run when the application is filed, and may be tolled only by mutual agreement or in cases where the reviewing

State or local government determines that the application is incomplete. The timeframe for review is not tolled by a moratorium on the review of applications.

(i) To toll the timeframe for incompleteness, the reviewing State or local government must provide written notice to the applicant within 30 days of receipt of the application, clearly and specifically delineating all missing documents or information. Such delineated information is limited to documents or information meeting the standard under paragraph (c)(1) of this section.

(ii) The timeframe for review begins running again when the applicant makes a supplemental submission in response to the State or local government's notice of incompleteness.

(iii) Following a supplemental submission, the State or local government will have 10 days to notify the applicant that the supplemental submission did not provide the information identified in the original notice delineating missing information. The timeframe is tolled in the case of second or subsequent notices pursuant to the procedures identified in this paragraph (c)(3). Second or subsequent notices of incompleteness may not specify missing documents or information that were not delineated in the original notice of incompleteness.

(4) *Failure to act.* In the event the reviewing State or local government fails to approve or deny a request seeking approval under this section within the timeframe for review (accounting for any tolling), the request shall be deemed granted. The deemed grant does not become effective until the applicant notifies the applicable reviewing authority in writing after the review period has expired (accounting for any tolling) that the application has been deemed granted.

(5) *Remedies.* Applicants and reviewing authorities may bring claims related to Section 6409(a) to any court of competent jurisdiction.

[80 FR 1269, Jan. 8, 2015. Redesignated and amended at 83 FR 51886, Oct. 15, 2018; 85 FR 78018, Dec. 3, 2020]





# PUBLIC NOTICE

Federal Communications Commission  
445 12<sup>th</sup> St., S.W.  
Washington, D.C. 20554

News Media Information 202 / 418-0500  
Internet: <http://www.fcc.gov>  
TTY: 1-888-835-5322

---

## WIRELESS TELECOMMUNICATIONS BUREAU OFFERS GUIDANCE ON INTERPRETATION OF SECTION 6409(a) OF THE MIDDLE CLASS TAX RELIEF AND JOB CREATION ACT OF 2012

DA 12-2047  
January 25, 2013

On February 22, 2012, the Middle Class Tax Relief and Job Creation Act of 2012 (Tax Act)<sup>1</sup> became law. Section 6409(a) of the Tax Act provides that a state or local government “may not deny, and shall approve” any request for collocation, removal, or replacement of transmission equipment on an existing wireless tower or base station, provided this action does not substantially change the physical dimensions of the tower or base station.<sup>2</sup> The full text of Section 6409(a) is reproduced in the Appendix to this Public Notice.

To date, the Commission has not received any formal petition to interpret or apply the provisions of Section 6409(a). We also are unaware of any judicial precedent interpreting or applying its terms. The Wireless Telecommunications Bureau has, however, received informal inquiries from service providers, facilities owners, and state and local governments seeking guidance as to how Section 6409(a) should be applied. In order to assist interested parties, this Public Notice summarizes the Bureau’s understanding of Section 6409(a) in response to several of the most frequently asked questions.<sup>3</sup>

### What does it mean to “substantially change the physical dimensions” of a tower or base station?

Section 6409(a) does not define what constitutes a “substantial[] change” in the dimensions of a tower or base station. In a similar context, under the *Nationwide Collocation Agreement* with the Advisory Council on Historic Preservation and the National Conference of State Historic Preservation Officers, the Commission has applied a four-prong test to determine whether a collocation will effect a “substantial increase in the size of [a] tower.”<sup>4</sup> A proposed collocation that does not involve a substantial increase in

---

<sup>1</sup> Middle Class Tax Relief and Job Creation Act of 2012, Pub. L. 112-96, H.R. 3630, 126 Stat. 156 (enacted Feb. 22, 2012) (Tax Act).

<sup>2</sup> *Id.*, § 6409(a).

<sup>3</sup> Although we offer this interpretive guidance to assist parties in understanding their obligations under Section 6409(a), *see, e.g., Truckers United for Safety v. Federal Highway Administration*, 139 F.3d 934 (D.C.Cir. 1998), the Commission remains free to exercise its discretion to interpret Section 6409(a) either by exercising its rulemaking authority or through adjudication. With two exceptions not relevant here, the Tax Act expressly grants the Commission authority to “implement and enforce” this and other provisions of Title VI of that Act “as if this title is a part of the Communications Act of 1934 (47 U.S.C. 151 et seq.)” Tax Act § 6003.

<sup>4</sup> 47 C.F.R. Part 1, App. B, *Nationwide Programmatic Agreement for the Collocation of Wireless Antennas*, § I.C. (*Nationwide Collocation Agreement*).

size is ordinarily excluded from the Commission's required historic preservation review under Section 106 of the National Historic Preservation Act (NHPA).<sup>5</sup> The Commission later adopted the same definition in the *2009 Declaratory Ruling* to determine whether an application will be treated as a collocation when applying Section 332(c)(7) of the Communications Act of 1934.<sup>6</sup> The Commission has also applied a similar definition to determine whether a modification of an existing registered tower requires public notice for purposes of environmental review.<sup>7</sup>

Under Section I.C of the *Nationwide Collocation Agreement*, a "substantial increase in the size of the tower" occurs if:

- 1) [t]he mounting of the proposed antenna on the tower would increase the existing height of the tower by more than 10%, or by the height of one additional antenna array with separation from the nearest existing antenna not to exceed twenty feet, whichever is greater, except that the mounting of the proposed antenna may exceed the size limits set forth in this paragraph if necessary to avoid interference with existing antennas; or
- 2) [t]he mounting of the proposed antenna would involve the installation of more than the standard number of new equipment cabinets for the technology involved, not to exceed four, or more than one new equipment shelter; or
- 3) [t]he mounting of the proposed antenna would involve adding an appurtenance to the body of the tower that would protrude from the edge of the tower more than twenty feet, or more than the width of the tower structure at the level of the appurtenance, whichever is greater, except that the mounting of the proposed antenna may exceed the size limits set forth in this paragraph if necessary to shelter the antenna from inclement weather or to connect the antenna to the tower via cable; or
- 4) [t]he mounting of the proposed antenna would involve excavation outside the current tower site, defined as the current boundaries of the leased or owned property surrounding the tower and any access or utility easements currently related to the site.

Although Congress did not adopt the Commission's terminology of "substantial increase in size" in Section 6409(a), we believe that the policy reasons for excluding from Section 6409(a) collocations that substantially change the physical dimensions of a structure are closely analogous to those that animated the Commission in the *Nationwide Collocation Agreement* and subsequent proceedings. In light of the Commission's prior findings, the Bureau believes it is appropriate to look to the existing definition of "substantial increase in size" to determine whether the collocation, removal, or replacement of equipment

---

<sup>5</sup> See 16 U.S.C. § 470f, *see also* 47 C.F.R. § 1.1307(a)(4) (requiring applicants to determine whether proposed facilities may affect properties that are listed, or are eligible for listing, in the National Register of Historic Places).

<sup>6</sup> See Petition for Declaratory Ruling to Clarify Provisions of Section 332(c)(7)(B) to Ensure Timely Siting Review and to Preempt Under Section 253 State and Local Ordinances that Classify All Wireless Siting Proposals as Requiring a Variance, WT Docket No. 08-165, *Declaratory Ruling*, 24 FCC Rcd. 13994, 14012, para. 46 & n.146 (2009) (*2009 Declaratory Ruling*), *recon. denied*, 25 FCC Rcd. 11157 (2010), *pet. for review denied sub nom. City of Arlington, Texas v. FCC*, 668 F.3d 229 (5<sup>th</sup> Cir.), *cert. granted*, 113 S.Ct. 524 (2012); 47 U.S.C. § 332(c)(7).

<sup>7</sup> See 47 C.F.R. § 17.4(c)(1)(B); National Environmental Policy Act Compliance for Proposed Tower Registrations, WT Docket No. 08-61, *Order on Remand*, 26 FCC Rcd. 16700, 16720-21, para. 53 (2011).

on a wireless tower or base station substantially changes the physical dimensions of the underlying structure within the meaning of Section 6409(a).

### **What is a “wireless tower or base station”?**

A “tower” is defined in the *Nationwide Collocation Agreement* as “any structure built for the sole or primary purpose of supporting FCC-licensed antennas and their associated facilities.”<sup>8</sup> The Commission has described a “base station” as consisting of “radio transceivers, antennas, coaxial cable, a regular and backup power supply, and other associated electronics.”<sup>9</sup> Section 6409(a) applies to the collocation, removal, or replacement of equipment on a wireless tower or base station. In this context, we believe it is reasonable to interpret a “base station” to include a structure that currently supports or houses an antenna, transceiver, or other associated equipment that constitutes part of a base station.<sup>10</sup> Moreover, given the absence of any limiting statutory language, we believe a “base station” encompasses such equipment in any technological configuration, including distributed antenna systems and small cells.

Section 6409(a) by its terms applies to any “wireless” tower or base station. By contrast, the scope of Section 332(c)(7) extends only to facilities used for “personal wireless services” as defined in that section.<sup>11</sup> Given Congress’s decision not to use the pre-existing definition from another statutory provision relating to wireless siting, we believe the scope of a “wireless” tower or base station under Section 6409(a) is not intended to be limited to facilities that support “personal wireless services” under Section 332(c)(7).

### **May a state or local government require an application for an action covered under Section 6409(a)?**

Section 6409(a) states that a state or local government “may not deny, and shall approve, any eligible facilities request....” It does not say that a state or local government may not require an application to be filed. The provision that a state or local government must approve and may not deny a request to take a covered action, in the Bureau’s view, implies that the relevant government entity may require the filing of an application for administrative approval.

---

<sup>8</sup> See *Nationwide Collocation Agreement*, § I.B.

<sup>9</sup> See Implementation of Section 6002(b) of the Omnibus Budget Reconciliation Act of 1993, WT Docket No. 10-133, *Annual Report and Analysis of Competitive Market Conditions With Respect to Mobile Wireless, Including Commercial Mobile Services, Fifteenth Report*, 26 FCC Rcd. 9664, 9481, para. 308 (2011).

<sup>10</sup> See also 47 C.F.R. Part 1, App. C, *Nationwide Programmatic Agreement Regarding the Section 106 National Historic Preservation Act Review Process*, § II.A.14 (defining “tower” to include “the on-site fencing, equipment, switches, wiring, cabling, power sources, shelters, or cabinets associated with that Tower but not installed as part of an Antenna as defined herein”).

<sup>11</sup> 47 U.S.C. § 332(c)(7)(A). “Personal wireless services” is in turn defined to mean “commercial mobile services, unlicensed wireless services, and common carrier wireless exchange access services.” *Id.* § 332(c)(7)(C)(1).



**Is there a time limit within which an application must be approved?**

Section 6409(a) does not specify any period of time for approving an application. However, the statute clearly contemplates an administrative process that invariably ends in approval of a covered application. We believe the time period for processing these applications should be commensurate with the nature of the review.

In the *2009 Declaratory Ruling*, the Commission found that 90 days is a presumptively reasonable period of time to process collocation applications.<sup>12</sup> In light of the requirement of Section 6409(a) that the reviewing authority “may not deny, and shall approve” a covered request, we believe that 90 days should be the maximum presumptively reasonable period of time for reviewing such applications, whether for “personal wireless services” or other wireless facilities.

Wireless Telecommunications Bureau contact: Maria Kirby at (202) 418-1476 or by email: [Maria.Kirby@fcc.gov](mailto:Maria.Kirby@fcc.gov).

-FCC-

For more news and information about the Federal Communications Commission please visit: [www.fcc.gov](http://www.fcc.gov)

---

<sup>12</sup> See *2009 Declaratory Ruling*, 24 FCC Rcd. at 14012-13, paras. 46-47.

## **APPENDIX**

### **SEC. 6409. WIRELESS FACILITIES DEPLOYMENT.**

#### **(a) FACILITY MODIFICATIONS.**

(1) **IN GENERAL.** Notwithstanding section 704 of the Telecommunications Act of 1996 (Public Law 104–104) or any other provision of law, a State or local government may not deny, and shall approve, any eligible facilities request for a modification of an existing wireless tower or base station that does not substantially change the physical dimensions of such tower or base station.

(2) **ELIGIBLE FACILITIES REQUEST.** For purposes of this subsection, the term “eligible facilities request” means any request for modification of an existing wireless tower or base station that involves —  
(A) collocation of new transmission equipment;  
(B) removal of transmission equipment; or  
(C) replacement of transmission equipment.

(3) **APPLICABILITY OF ENVIRONMENTAL LAWS.** Nothing in paragraph (1) shall be construed to relieve the Commission from the requirements of the National Historic Preservation Act or the National Environmental Policy Act of 1969.

1815 Mass Ave

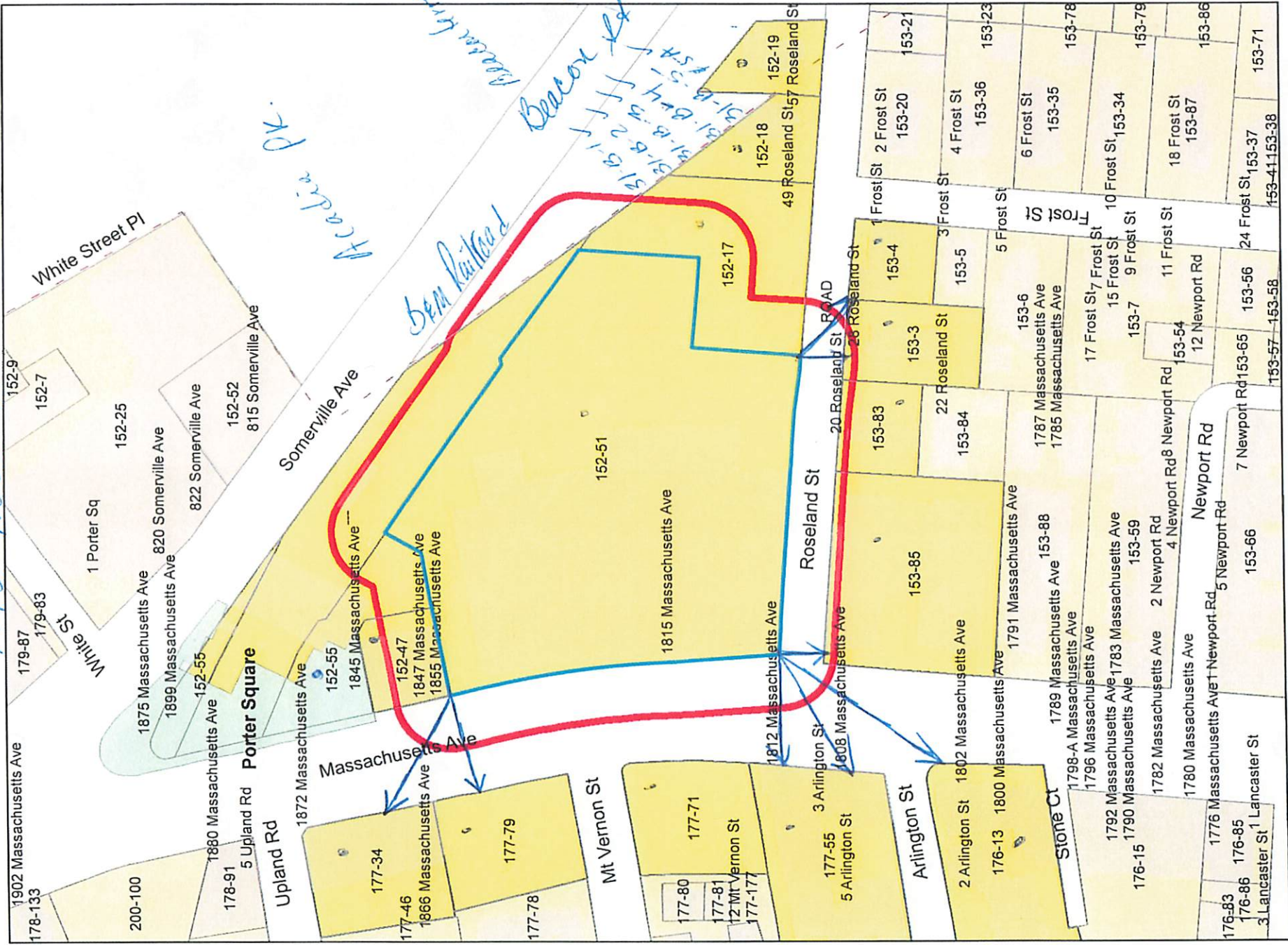



Somerville map

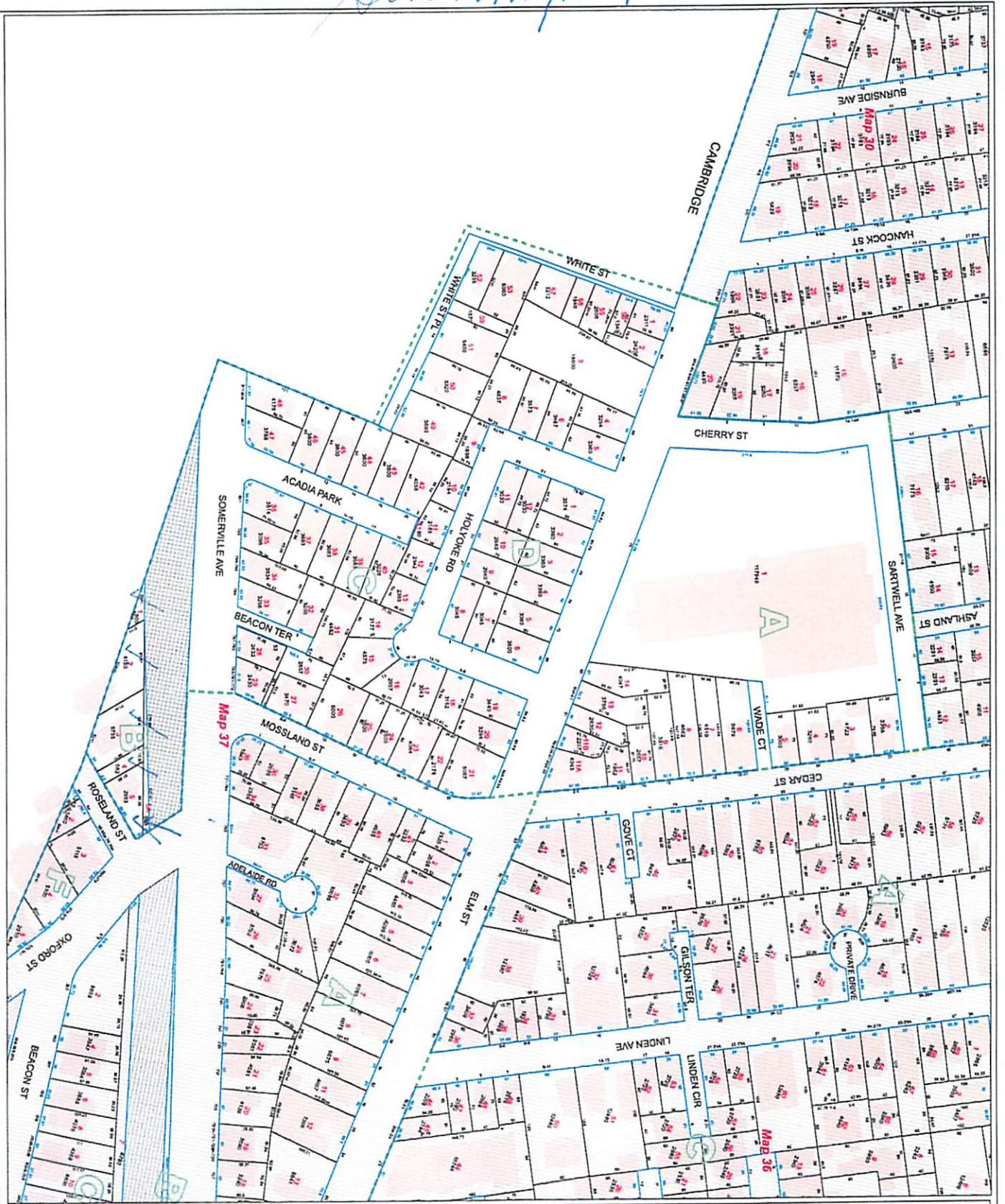

City of  
**Somerville**  
Massachusetts

**Assessors Map**

- Parcel Boundary
- Block/ROW Boundary
- Other ROW Boundary
- Assessor Map Boundary
- Water Body
- Building
- Railroad ROW

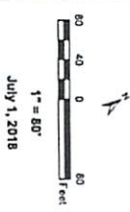
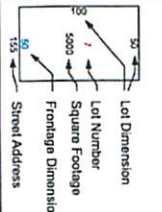

Source: Rights-of-way and building footprints were originally developed from Boston Edison City of Somerville. Parcel data were originally developed from assessor maps by CDOT, based on City of Somerville records.

NOTE: The data represented on these maps includes distances and detailed features of parcels. They are NOT survey data and should not be used as such.

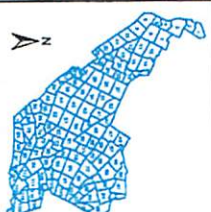

**31**



1815 Mass Ave

147

Petitioner

152-18-51-17  
LESLEY COLLEGE  
29 EVERETT STREET  
CAMBRIDGE, MA 02138

152-19  
RICCI, DOMENICK & JOSEPHINE RICCI  
C/O MAREK JITKA  
57 ROSELAND STREET #3  
SOMERVILLE, MA 02143

BROWN RUDNICK LLP  
C/O MICHAEL R. DOLAN, ESQ.  
ONE FINANCIAL CENTER  
BOSTON, MA 02111

152-55  
MASSACHUSETTS BAY TRANSPORTATION  
AUTHORITY  
10 PARK PLAZA  
BOSTON, MA 02116

152-47  
MAYER, EDWARD A. & LOUISE M. MAYER  
14 TURNER RD  
N. BILLERICA, MA 01862

153-3-4  
FARRINGTON REALTY LLC,  
28 ROSELAND ST., #1  
CAMBRIDGE, MA 02140

176-13  
ROQUERRE, TIESHUN  
1446 CAMBRIDGE ST  
CAMBRIDGE, MA 02139

176-13  
CROWLEY, STEPHEN A.  
11174 WESTPORT DRIVE  
WEST DES MOINES, IA 50266

176-13  
COLLINS, MARGARET R.  
2-6 ARLINGTON ST., #2  
CAMBRIDGE, MA 02140

176-13  
THEALL, STEPHEN J. JR.  
4 ARLINGTON ST., UNIT #2  
CAMBRIDGE, MA 02140

176-13  
LIGRESTI, LEONARDO & SILVA SPRINGOLO  
VIA MILAZZO 7,  
35139 PADOVA, \_ \_

176-13  
WHITE, ROSEMARY D. & MARY H. WHITE  
2 ARLINGTON ST. UNIT#23  
CAMBRIDGE, MA 02140

176-13  
BOARDMAN, RICHARD B. & LYNNE A. STANTON  
2 ARLINGTON ST. UNIT#33  
CAMBRIDGE, MA 02140

176-13  
HOFFMAN, JANICE,  
TR. THE JANICE HOFFMAN 2016LIV TRUST  
28 GLEASON STREET  
WATERTOWN, MA 02472

176-13  
STUART, SEBASTIAN & STEPHEN D. MCCAULEY  
4 ARLINGTON ST #21  
CAMBRIDGE, MA 02140

176-13  
DALTON, KATHY L.  
6 ARLINGTON ST #12  
CAMBRIDGE, MA 02140

176-13  
POPE, WILLARD R. & SYLVIA C. POPE  
6 ARLINGTON ST., #21  
CAMBRIDGE, MA 02140

176-13  
FREIDBERG, SUSANNE  
6 ARLINGTON ST., UNIT #6/31  
CAMBRIDGE, MA 02140

176-13  
TSERLIN, ELINA  
1800 MASS AVE. UNIT#4  
CAMBRIDGE, MA 02140

176-13  
LIN, ALEXANDER & CHUN PI LIN HUANG  
1800 MASSACHUSETTS AVE. - UNIT 800/5  
CAMBRIDGE, MA 02140

176-13  
DANBERG, SEYMOUR A.  
TR. DANBERG CAMBRIDGE REALTY TRUST  
P.O. BOX 425091  
CAMBRIDGE, MA 02140

176-13  
AZABU, LLC  
1-3-15 MINAMI  
AZABU, MINATOKI, \_ \_

176-13  
S.R.A. PARUCHURI  
1060 OAKTREE LN  
BLOOMFIELD HILLS, MI 48304

176-13  
CHAO, HUNG-HSING  
1800 MASSACHUSETTS AVE., #11  
CAMBRIDGE, MA 02140

176-13  
BOWDEN, KRISTEN M.  
C/O ALEX STEINBERGH & R. STANLEY BOWDEN  
17 IVALOO ST., SUITE#100  
SOMERVILLE, MA 02143

176-13  
LIU, HONG & TIEMAE ROQUERRE  
89 CALFLIN ST  
BELMONT, MA 02478

176-13  
SCHILLER, LAUREN E.  
5421 S. CORNELL AVE #9  
CHICAGO, IL 60615

176-13  
NEELY, CLAIRE G.  
2 ARLINGTON ST #11  
CAMBRIDGE, MA 02140

176-13  
RABB, INTISAR  
2 ARLINGTON ST. UNIT#32  
CAMBRIDGE, MA 02140

176-13  
PODBELSKI, JANA J.  
334 PROVIDENCE RD  
SO. GRAFTON, MA 01560

176-13  
BOWDEN, SHAREN K. C/O R C G  
17 IVALOO ST, STE 100  
SOMERVILLE, MA 02143

176-13  
SIMONS, REBECCA L.  
1800 MASS AVE, #3  
CAMBRIDGE, MA 02140

176-13  
LIFSEY, ANGELA  
1800 MASS AVENUE, UNIT 80021  
CAMBRIDGE, MA 02140

176-13  
WFB FUTURAMA RENTALS LLC.  
C/O RESOURCE CAPITAL RENTALS LLC  
17 IVALOO ST. SUITE #100  
SOMERVILLE, MA 02143

176-13  
BERKELEY, JEROME  
12 COUSENS CIRCLE  
NEWTON, MA 02459

176-13  
BROOKS, JAMES E.  
364 SPRING ST  
PORTLAND, ME 04102

176-13  
HU, CHIA-LING & CINDY HU  
6 ARLINGTON ST., #32  
CAMBRIDGE, MA 02140

176-13  
JI, XIAOAN & ZHAODIAN JI  
4 ARLINGTON ST UNIT 11A  
CAMBRIDGE, MA 02140

176-13  
BOWDEN, MILISSA L.  
C/O RCG  
17 IVALOO ST., SUITE #100  
SOMERVILLE, MA 02143

176-13  
SHIUE, REN-JYE & CHIH-WEI CHANG  
1800 MASSACHUSETTS AVE. - #80031  
CAMBRIDGE, MA 02140

176-13  
PERDIKOLOGOS, CONSTANTINA  
FOTINI PERDIKOLOGOS  
1802 MASS AVE #11  
CAMBRIDGE, MA 02139

176-13  
WEISS, JUDITH  
21 ORCHARD ST., #2  
CAMBRIDGE, MA 02140

177-55  
GIANI, LUCA  
5 ARLINGTON ST - UNIT 5-53  
CAMBRIDGE, MA 02140

153-85  
LESLEY UNIVERSITY  
39 EVERETT ST.  
CAMBRIDGE, MA 02138

176-13  
HUANG, CHUN PI LIN  
1800 MASS AVE. UNIT 33  
CAMBRIDGE, MA 02140

176-13  
LIU, HONG,  
TR. 1802 MASS AVENUE REALTY TRUST  
1673 CAMBRIDGE ST.  
CAMBRIDGE, MA 02138

153-83  
FARRINGTON, SARAH M., SAMUEL F. &  
JOHN L. FARRINGTON  
28 ROSELAND ST., #1  
CAMBRIDGE, MA 02140

177-55  
SORRENTINO, MARIE SANDY SORRENTINO  
REAL ESTATE LLC  
252 COLLAMER RD  
HILTON, NY 14468

177-55  
FERNANDEZ, MERCEDES  
3333 NE 34TH ST #1505  
FT. LAUDERDALE, FL 33308

177-55  
PLAYFAIR, SUSAN R.  
10 ROGERS STREET #302  
CAMBRIDGE, MA 02142

177-55  
CARTAGINE, CARLOS  
3 ARLINGTON ST. UNIT#3/4  
CAMBRIDGE, MA 02139

177-55  
JAMES, WILLIAM D. & NANCY B. JAMES  
14 COVE ROAD UNIT 3  
ORLEANS, MA 02653

176-13  
SHEN, KE & HUI LIU TRS HUI LIU 2018  
REVOCABLE TRUST  
4 ARLINGTON ST - UNIT 1  
CAMBRIDGE, MA 02140

177-55  
MARENTES LUIS A. & NEGAR TARADJI,  
TRS THE MARENTES TARADJI FAMILY TR  
31 WILLOW ST  
CONCORD, MA 01742

177-55  
HUGHES, ELISABETH  
3 ARLINGTON ST., UNIT #24  
CAMBRIDGE, MA 02140

177-55  
LAW, MICHAEL  
3 ARLINGTON STREET UNIT #3-27  
CAMBRIDGE, MA 02140

177-55  
JI, XIAOAN & ZHAODIAN JI  
4 ARLINGTON ST 11A  
CAMBRIDGE, MA 02139

177-55  
FRATTINI, WILLIAM  
ABIGAIL H FRATTINI  
3 WHEELER RD  
LEXINGTON, MA 02420

177-55  
GOPINATH, DINESH  
35 LANGDON STREET  
NEWTON, MA 02458

177-55  
MCNULTY, JAMES P.  
210 GARDEN ST  
CAMBRIDGE, MA 02138



177-55  
BENNETT, MONICA M. & MICHAEL F. BENNETT  
TRUSTEE OF M.M.B. LIVING TRUST  
5 ARLINGTON ST. UNIT5/21  
CAMBRIDGE, MA 02140

177-55  
BANG, YOONSHIN  
7 ARLINGTON ST. UNIT#24  
CAMBRIDGE, MA 02138

177-55  
GILES, RICHARD H. & SUZANNE E. LAKE,  
TRS OF ARLINGTON OXFORD REALTY TRUST  
12 DEER PATH APT 3  
MAYNARD, MA 01754

177-55  
ASHLEY, GISELA  
7 ARLINGTON ST #7  
CAMBRIDGE, MA 02140

177-55  
ORFALI, MERCEDES  
3333 NE 34TH ST #1505  
FT. LAUDERDALE, FL 33308

177-55  
MURPHY, KATHLEEN M.,  
TRUSTEE THE MOLLY SOLOMON TRUST  
P.O. BOX 427  
MARBLEHEAD, MA 01945

177-55  
PETERS, ANNE C.,  
TRUSTEE THE ANNE C. PETERS TRUST  
5 ARLINGTON ST., #5/25  
CAMBRIDGE, MA 02140

177-55  
FLANNERY, SUSAN M. & STEPHEN A. COREN  
5 ARLINGTON ST #45  
CAMBRIDGE, MA 02140

177-55  
DUONG, LOC  
7 ARLINGTON ST., UNIT #7/21  
CAMBRIDGE, MA 02140

177-55  
MORSE, PHILIP  
TRUSTEE OF PHILIP MORSE TRUST  
7 ARLINGTON ST UNIT 7/57  
CAMBRIDGE, MA 02140

177-55  
RUBINSKY, MELISSA B.  
5 ARLINGTON ST #44  
CAMBRIDGE, MA 02140

177-55  
KNAPP, MARY M  
9 SHEFFIELD WAY  
WESTBOROUGH, MA 01581

177-34  
1868 MASS AVE LLC  
109 SCHOOL ST  
WATERTOWN, MA 02472

177-55  
TERWILLIGER, CYNTHIA J.  
7 ARLINGTON ST #8  
CAMBRIDGE, MA 02140

177-55  
HOFMANN, ANDREAS G., TRUSTEE OF THE  
ROSEMARIE HOFMANN IRREVOCABLE TRS  
3 ARLINGTON ST., UNIT 3/51  
CAMBRIDGE, MA 02140

177-55  
WALSH, MICHAEL A. &  
MAUREEN P. MANNING TRUSTEES  
3 ARLINGTON ST., #3/57  
CAMBRIDGE, MA 02140

177-55  
BISHKO, ADRIANE  
5 ARLINGTON ST. UNIT#5/26  
CAMBRIDGE, MA 02140

177-55  
LENIHAN, WINIFRED  
5 ARLINGTON ST #55  
CAMBRIDGE, MA 02140

177-55  
BRAND, SUSAN F.  
7 ARLINGTON ST #23  
CAMBRIDGE, MA 02140

177-55  
KNOLL, VANESSA  
3 ARLINGTON ST., #3/3  
CAMBRIDGE, MA 02140

177-55  
FANTASIA, MEREDITH  
5 ARLINGTON ST., #5/51  
CAMBRIDGE, MA 02140

177-55  
CARDELLICHIO, PETER A  
7 ARLINGTON ST #44  
CAMBRIDGE, MA 02140

177-55  
FILENE, JACOB F.  
5726 S.MACON STREET  
ENGLEWOOD, CO 80111

177-55  
LU, CHENCHEN & QIHAN LIU  
3 ARLINGTON ST UNIT 23  
CAMBRIDGE, MA 02140

177-55  
THAYER DOUGLAS G. & DONALD THAYER  
ARLINGTON ST REAL ESTATE TRUST  
C/O THAYER & ASSOCIATES  
1812 MASSACHUSETTS AVE  
CAMBRIDGE, MA 02140

177-55  
YU, KONGJIAN  
5 ARLINGTON ST UNIT 22  
CAMBRIDGE, MA 02140

177-55  
SCORDATO, CHRISTINE A.  
1313 WASHINGTON ST  
BOSTON, MA 02118

177-55  
JOYCE, MARYBETH M.  
5 ARLINGTON ST #B1  
CAMBRIDGE, MA 02140

177-55  
ROBERTS, KAY G.  
7 ARLINGTON ST #42  
CAMBRIDGE, MA 02140

177-55  
WU, FEI  
3 ARLINGTON ST., #3/6  
CAMBRIDGE, MA 02140

1815 Mass Ave

497

177-55  
SHAO, MIN & YING CHEN  
C/O PHILIP TSENG  
63 WHEELLOCK ROAD  
WALTHAM, MA 02453

177-55  
TOBIN, SUSANNAH BARTON  
3 ARLINGTON ST. UNIT# 21  
CAMBRIDGE, MA 02140

177-55  
ROVINELLI, H. PAUL  
3 ARLINGTON ST. UNIT#26  
CAMBRIDGE, MA 02140

177-55  
HUANG, IRENE C. & ANDREW WANG  
166 WOODCLIFF ROAD  
NEWTON, MA 02161

177-55  
BORINS, LAWRENCE A.  
5 ARLINGTON ST #36  
CAMBRIDGE, MA 02140

176-13  
CROWLEY, JR. , STEPHEN ANTHONY &  
ANGELA MARIE BISANTI  
11174 WESTPORT DRIVE  
WEST DES MOINES, IA 50266

177-55  
LICUANAN, ANA  
5 ARLINGTON ST., #5/56  
CAMBRIDGE, MA 02140

177-55  
OLBERT, STANISLAW & NORMA L. OLBERT  
TRUSTEE STANISLAW & NORMA L. OLBERT TR.  
50 FOLLEN ST UNIT 36  
CAMBRIDGE, MA 02140

177-55  
EKSTROM, GORAN A.  
7 ARLINGTON ST #52  
CAMBRIDGE, MA 02140

176-13  
MO NEETA, LLC  
18 WHITEHALL WAY  
BELLINGHAM, MA 02019

177-55  
DURSO, JAMES E & ELIZABETH L. FOSNIGHT  
C/O OXFORD STREET REALTY  
1644 MASS AVE  
CAMBRIDGE, MA 02138

177-55  
DONG, HUI,  
TRUSTEE THE ARLINGTON PORTER TRUST  
PO BOX 456  
WINCHESTER, MA 01890

177-55  
FU, BING & JING WANG  
3 ARLINGTON ST #3/31  
CAMBRIDGE, MA 02140

177-55  
SIMMONS, ALFRED M.  
3 ARLINGTON ST., UNIT #3  
CAMBRIDGE, MA 02140

177-55  
MATTHEWS, DAVID LEE & TERRI HUME OLIVER  
5 ARLINGTON ST. UNIT#42  
CAMBRIDGE, MA 02140

177-55  
1812 MASSACHUSETTS AVENUE LLC,  
C/O W.T. PHELAN INS. AGENCY  
63 TRAPELO ROAD  
BELMONT, MA 02478

177-55  
MILBOUER, LANCE E.  
7 ARLINGTON ST #26  
CAMBRIDGE, MA 02140

177-55  
ROBERTS, KAY GEORGE  
7 ARLINGTON ST #43  
CAMBRIDGE, MA 02140

177-55  
BOLTER, HENRY  
5 ARLINGTON ST - UNIT #1  
CAMBRIDGE, MA 02140

176-13  
CHU, ANDREW C. & MICHELLE I. LAI TRUSTEES  
10849 N. STELLING RD  
CUPERTINO, CA 95014

177-55  
MYERS, ALAN G.  
7 ARLINGTON ST #4  
CAMBRIDGE, MA 02140

177-55  
THORNE, NELL  
3 ARLINGTON ST., UNIT #3/25  
CAMBRIDGE, MA 02140

177-55  
LOI, SALLY  
59 TREMONT ST #1  
CAMBRIDGE, MA 02139

177-55  
MOORES, MARJORIE J.  
5 ARLINGTON ST #31  
CAMBRIDGE, MA 02140

176-13  
SMITH, JULIA  
4 ARLINGTON ST., UNIT #6  
CAMBRIDGE, MA 02139

177-55  
COLLINS, HALSEY B  
3556 77TH ST. APT 32  
JACKSON HEIGHTS , NY 11372

177-55  
KIMBALL, WILLIAM S.  
7 ARLINGTON ST #27  
CAMBRIDGE, MA 02140

177-55  
YANG, CHIANHWA  
1461 26TH AVE NE  
ISSAQUAH , WA 98029

176-13  
PALMER, DOUGLAS J.,  
C/O OXFORD STREET REALTY, INC.  
1644 MASS AVE  
CAMBRIDGE, MA 02138

176-13  
CHANG, CHRISTINE Z. & PATRICK C. MCLEAN  
66 ELIZABETH ROAD  
BELMONT, MA 02478

176-13  
LEE, HYEJIN  
1 EARHART ST #506  
CAMBRIDGE, MA 02141

176-13  
MARGULIS T. N.  
C/O RCG LLC,  
17 IVALOO ST., SUITE#100  
SOMERVILLE, MA 02143

177-55  
ABID, ZEHRA & CITY OF CAMBRIDGE TAX TITLE  
1-7 ARLINGTON ST., UNIT #3/7  
CAMBRIDGE, MA 02140

177-55  
ORFALI, MERCEDES  
3333 NE 34TH ST #1505  
FT. LAUDERDALE, FL 33308

177-55  
PAOLINI, ELENA L.  
3 ARLINGTON ST. UNIT#45  
CAMBRIDGE, MA 02140

177-55  
COLLINS, JOHN A. C/O ANDY ZWICK  
4779 COLLINS AVE APT#4102  
MIAMI BEACH, FL 33140

177-55  
LICUANAN, FRANCISCO & VICTORIA LICUANAN  
5 ARLINGTON ST., UNIT #54  
CAMBRIDGE, MA 02140

177-71-79  
LESLEY COLLEGE  
29 EVERETT STREET  
CAMBRIDGE, MA 02138

177-55  
CHAN, SZE HAM  
C/O REAL PROPERTY MGMT COMMONWEALTH  
245 FIRST ST, 18TH FL  
CAMBRIDGE, MA 02142

177-55  
ARONSTEIN, JUDITH RICE SUSAN  
5 ARLINGTON ST - UNIT 5-52  
CAMBRIDGE, MA 02140

176-13  
LANDERS, DEBORAH D.  
4 ARLINGTON ST., UNIT #22  
CAMBRIDGE, MA 02140

177-55  
JALAL, AYESHA  
92 ORCHARD ST.  
SOMERVILLE, MA 02144

177-55  
SCOTT, LAURIE A.  
5 ARLINGTON ST #3  
CAMBRIDGE, MA 02140

177-55  
RUBIN, NOOREEN T.  
3 ARLINGTON ST., #3/33  
CAMBRIDGE, MA 02140

177-55  
CHANG, NANCY T.  
TRUSTEE OF NANCY T. CHANG REVOCABLE TRST  
REVOCABLE TRUST  
1644 MASS AVE  
CAMBRIDGE, MA 02138

177-55  
BANKLER, BETH A.  
5 ARLINGTON ST #34  
CAMBRIDGE, MA 02140

177-55  
BRAND, SUSAN F.  
7 ARLINGTON ST #22  
CAMBRIDGE, MA 02140

177-55  
VU, LIM DINH & NGA HONG LY  
7 ARLINGTON ST UNIT 45  
CAMBRIDGE, MA 02140

177-55  
OXFORD COURTS REALTY INC. ARLINGTON STREET  
REAL ESTATE TRUST  
C/O THAYER & ASSOCIATES  
1812 MASSACHUSETTS AVE  
CAMBRIDGE, MA 02140

177-55  
SARANDOPOLIS MICHAEL MARY A  
SARANDOPOLIS  
75 GLEZEN LAND  
WAYLAND, MA 01778

176-13  
GRAZIOSI, ANDREA  
VIA ISOLA MADRE 3  
00141  
ROMA, - --

177-55  
ERDOSY, DANIEL P.,  
GABRIELLA ERDOSY MIKLOS ERDOSY  
3 ARLINGTON ST., #3/2  
CAMBRIDGE, MA 02140

177-55  
LOCSIN, JEAN LOUIS.  
5 ARLINGTON ST. UNIT#22  
CAMBRIDGE, MA 02140

177-55  
SUTHERLAND, LUCY R. TR.THE SUTHERLAND  
ARLINGTON STREET REALTY TRUST  
3 ARLINGTON ST., UNIT #43  
CAMBRIDGE, MA 02140

177-55  
WALSH, MICHAEL A. &  
MAUREEN P. MANNING TRUSTEES  
3 ARLINGTON ST., #3/56  
CAMBRIDGE, MA 02140

177-55  
BUFFUM, TIMOTHY A.  
5 ARLINGTON ST. UNIT#41  
CAMBRIDGE, MA 02140

177-55  
MCNULTY JAMES P. & SIRI C. STEINLE  
210 GARDEN ST  
CAMBRIDGE, MA 02138

177-55  
EKSTROM, GORAN A.  
7 ARLINGTON ST #52  
CAMBRIDGE, MA 02140

177-55  
MCDONAGH, JOHN P  
4 BALDWIN LANE  
AMHERST, MA 01002

177-55  
NOVICH, COREY  
3 ARLINGTON ST - UNIT 3-35  
CAMBRIDGE, MA 02140



1815 Mass Ave

697

177-55  
ASCH, REBECCA S.  
5 ARLINGTON ST UNIT 33  
CAMBRIDGE, MA 02140

177-55  
JIANG, YANKANG  
7 ARLINGTON ST UNIT 7/55  
CAMBRIDGE, MA 02140

177-55  
SOLOMON JONATHAN  
5 ARLINGTON ST UNIT 5-46  
CAMBRIDGE, MA 02140

176-13  
SUN VISTA TR  
8716 RIDGE RD  
BETHESDA, MD 20817

176-13  
WILLOW STRONG LLC  
145 PINCKNEY ST - APT #210  
BOSTON, MA 02114

176-13  
VEGGIE FAMILY REALTY LLC  
22 SHEAN RD  
BELMONT, MA 02478

176-13  
SPILKER HAROLD D III KIRSTEN O SPILKER  
937 HUNAKAI ST  
HONOLULU, HI 96816

177-55  
CURRIER, NICOLAS, SUZANNE PARK  
ELLEN S. HENDRIKSEN  
7 ARLINGTON ST UNIT 46  
CAMBRIDGE, MA 02140

177-55  
LEINBACH, KENNETH & MARION P HOGAN  
7 ARLINGTON ST - UNITS 31 32 & 33  
CAMBRIDGE, MA 02140

176-13  
EJS PRIVATE EQUITY LLC  
50 NEWTON ST  
BOSTON, MA 02135

177-55  
TANG, DANNI & JEFFREY A. SHNEIDMAN  
3 ARLINGTON ST #3/34  
CAMBRIDGE, MA 02140

176-13  
HARRIS, RICHARD A., PATRICIA HARRIS ALYSON  
A. POWERS & BRENDON HARRIS  
1800 MASSACHUSETTS AVE UNIT 14  
CAMBRIDGE, MA 02140

176-13  
SRA PARUCHURI  
TR SRA PARUCHURI LIVING TRUST  
1060 OAK TREE LN  
ROCHESTER HILLS, MI 48309

176-13  
PARUCHURI S.R.A TRUSTEE  
1060 OAK TREE LN  
ROCHESTER HILLS, MI 48309

177-55  
SPITZER, FRANKLIN  
7 ARLINGTON ST #7/37  
CAMBRIDGE, MA

176-13  
MINOTTI, TOD ROBERT TOSI,  
LINDA TOSI KEVIN LUKACEK, TRS  
253 NORFOLK ST  
CAMBRIDGE, MA 02139

176-13  
TAZAWA KAYOKO  
22 CASS ST  
EXETER, NH 03833

177-55  
KHOSLA MARK D  
7 ARLINGTON ST - UNIT 35  
CAMBRIDGE, MA 02140

177-55  
LARSON, RICHARD  
40 CHURCHILLS LANE - UNIT 41  
MILTON, MA 02186

177-55  
WILLIAMS, BROOKE S. &  
TERRY TEMPEST WILLIAMS  
HC 64 BOX 3601  
CASTLE VALLEY, UT 84532

176-13  
GONG, ZHENG YUGE XIAO  
76 TUDOR RD  
NEEDHAM, MA 02492

176-13  
URBAN RENEWAL 13 LLC  
C/O RCG LLC  
17 IVALOO ST, UNIT 4-10  
SOMERVILLE, MA 02143

177-55  
STONEWELL CAROLYN  
7 ARLINGTON ST - UNIT 56  
CAMBRIDGE, MA 02140

176-13  
CHUANG KEVIN SHUN-CHIEH & CHIH-SIN YU  
106 SHAW RD  
BELMONT, MA 02478

176-13  
GOSSELIN, JOHN T.  
TR. OF THE CHRISTINE M. CANNAVA REVOC TRT  
4 ARLINGTON ST 31  
CAMBRIDGE, MA 02140

176-13  
BI WENWEN & WENLONG TU  
11 HOLDEN ST - UNIT A  
BROOKLINE, MA 02445

176-13  
BROMBERGER ALLEN & DANIEL BROMBERGER  
30 PHILLIPS RD  
SOUTH PORTLAND, ME 04106

176-13  
ROQUERRE TIEQUIN  
12 SEAGRAVE RD  
CAMBRIDGE, MA 02140

SOMERVILLE ABUTTERS:

31-B-1  
LESLEY COLLEGE  
29 EVERETT STREET  
CAMBRIDGE, MA 02138

31-B-2  
LESLEY REALTY CORP.  
C/O LESLEY COLLEGE  
29 EVERETT STREET  
CAMBRIDGE, MA 02138

31-B-3 & B-4  
MAREK JITKA LIFE ESTATE  
57 ROSELAND STREET TRUST  
57 ROSELAND STREET  
SOMERVILLE, MA 02143

31-B-5-A  
MBTA  
C/O MARK DOYLE R E DIRECTOR  
10 PARK PLAZA – SUITE 5720  
BOSTON, MA 02116

31-B-5-1  
ANTHONY DANGERFIELD  
5 JOHNSON ROAD  
MEDFORD, MA 02155

31-B-5-2  
JEFFREY L. BROWN  
TR. SPRING MOUNTAIN REALTY TRUST  
61 ROSELAND STREET #2  
SOMERVILLE, MA 02143

31-B-5-3  
JEFFREY L. BROWN  
TR. SPRING MOUNTAIN AVE – SUITE 3  
ARLINGTON, MA 02476

31-B-5-4  
JAMES M. IGOE, III  
40 SKEHAN STREET  
SOMERVILLE, MA 02143

31-B-5-5  
EMILY H. BAILEY,  
TRS. EMILY H. BAILEY REVOCABLE TRUST  
105 LEXINGTON AVENUE  
CAMBRIDGE, MA 02138

31-B-5-6  
EMILY H. BAILEY  
TR. EMILY H. BAILEY REVOCABLE TRUST  
61 ROSELAND STREET #6  
SOMERVILLE, MA 02143

31-B-5-7 & 5-8  
THEODORE P. WASIK, MD.  
TRACEY A. DECHERT, MD.  
29 ALBION PLACE  
CHARLESTOWN, MA 02129

31-B-5-9  
ZOE LANGOSY  
TR. OF TN TRUST  
147 SHERMAN STREET #103  
CAMBRIDGE, MA 02140

31-B-5-10  
JOHN & JENNIFER GOTTLIEB  
401 WASHINGTON STREET  
SOMERVILLE, MA 02143

# ROSELAND ST

Location ROSELAND ST

Mblu 31/ B/ 1/ /

Acct# 19611020

Owner LESLEY COLLEGE

Assessment \$176,300

PID 328

Building Count 1

## Current Value

Assessment			
Valuation Year	Improvements	Land	Total
2023	\$1,500	\$174,800	\$176,300

## Owner of Record

Owner LESLEY COLLEGE  
 Co-Owner  
 Address 29 EVERETT ST  
 CAMBRIDGE, MA 02138

Sale Price \$1  
 Certificate  
 Book & Page 25269/ 543  
 Sale Date 04/05/1995  
 Instrument 1F

## Ownership History

Ownership History					
Owner	Sale Price	Certificate	Book & Page	Instrument	Sale Date
LESLEY COLLEGE	\$1		25269/ 543	1F	04/05/1995
LESLEY REALTY CORP	\$10		24763/ 155	1F	08/05/1994
C D I A INC TRUSTEE	\$0				

## Building Information

### Building 1 : Section 1

Year Built:  
 Living Area: 0  
 Replacement Cost: \$0  
 Building Percent Good:  
 Replacement Cost  
 Less Depreciation: \$0

Building Attributes	
Field	Description



# 49 ROSELAND ST

**Location** 49 ROSELAND ST

**Mblu** 31/ B/ 2/ 1

**Acct#** 06259086

**Owner** LESLEY REALTY CORP

**Assessment** \$1,016,500

**PID** 329

**Building Count** 1

## Current Value

Assessment			
Valuation Year	Improvements	Land	Total
2023	\$121,400	\$895,100	\$1,016,500

## Owner of Record

**Owner** LESLEY REALTY CORP  
**Co-Owner** C/O LESLEY COLLEGE  
**Address** 29 EVERETT STREET  
 CAMBRIDGE, MA 02138

**Sale Price** \$0  
**Certificate**  
**Book & Page** 24763/ 155  
**Sale Date** 08/05/1994  
**Instrument** 1F

## Ownership History

Ownership History					
Owner	Sale Price	Certificate	Book & Page	Instrument	Sale Date
LESLEY REALTY CORP	\$0		24763/ 155	1F	08/05/1994
TRUST 1815 REALTY	\$0				

## Building Information

### Building 1 : Section 1

**Year Built:** 1900  
**Living Area:** 4,156  
**Replacement Cost:** \$1,180,297  
**Building Percent Good:** 10  
**Replacement Cost**  
**Less Depreciation:** \$118,000

Building Attributes	
Field	Description
Style	Mansard-Apts

# 57 ROSELAND ST

Location 57 ROSELAND ST

Mblu 31/ B/ 3/ *14 B4*

Acct# 18572090

Owner MAREK JITKA LIFE ESTATE

Assessment \$1,547,100

PID 6085

Building Count 1

## Current Value

Assessment			
Valuation Year	Improvements	Land	Total
2023	\$734,800	\$812,300	\$1,547,100

## Owner of Record

Owner MAREK JITKA LIFE ESTATE  
Co-Owner 57 ROSELAND ST TRUST  
Address 57 ROSELAND ST  
SOMERVILLE, MA 02143

Sale Price \$1  
Certificate  
Book & Page 78029/ 293  
Sale Date 06/16/2021  
Instrument 1F

## Ownership History

Ownership History					
Owner	Sale Price	Certificate	Book & Page	Instrument	Sale Date
MAREK JITKA LIFE ESTATE	\$1		78029/ 293	1F	06/16/2021
MAREK JITKA	\$314,000		21567/ 082	A	11/27/1991
FREDERIC RAPHAEL	\$0				

## Building Information

### Building 1 : Section 1

Year Built: 1860  
Living Area: 3,364  
Replacement Cost: \$1,064,931  
Building Percent Good: 69  
Replacement Cost  
Less Depreciation: \$734,800

Building Attributes	
Field	Description

# 000R BEACON ST

**Location** 000R BEACON ST

**Mblu** 31/ B/ 5/A/

**Acct#** 20131200

**Owner** MBTA

**Assessment** \$175,900

**PID** 110228

**Building Count** 1

## Current Value

Assessment			
Valuation Year	Improvements	Land	Total
2023	\$0	\$175,900	\$175,900

## Owner of Record

<b>Owner</b>	MBTA	<b>Sale Price</b>	\$0
<b>Co-Owner</b>	C/O MARK DOYLE R E DIRECTOR	<b>Certificate</b>	
<b>Address</b>	10 PARK PLAZA SUITE 5720	<b>Book &amp; Page</b>	00000/ 000
	BOSTON, MA 02116	<b>Sale Date</b>	01/01/1970

## Ownership History

Ownership History				
Owner	Sale Price	Certificate	Book & Page	Sale Date
MBTA	\$0		00000/ 000	01/01/1970

## Building Information

### Building 1 : Section 1

**Year Built:**  
**Living Area:** 0  
**Replacement Cost:** \$0  
**Building Percent Good:**  
**Replacement Cost**  
**Less Depreciation:** \$0

Building Attributes	
Field	Description
Style	Vacant Land
Model	



# 61 ROSELAND ST #1

**Location** 61 ROSELAND ST #1

**Mblu** 31/ B/ 5/ 1/

**Acct#** 20131100

**Owner** DANGERFIELD ANTHONY

**Assessment** \$126,500

**PID** 110218

**Building Count** 1

## Current Value

Assessment			
Valuation Year	Improvements	Land	Total
2023	\$126,500	\$0	\$126,500

## Owner of Record

**Owner** DANGERFIELD ANTHONY  
**Co-Owner**  
**Address** 5 JOHNSON RD  
 MEDFORD, MA 02155

**Sale Price** \$99,000  
**Certificate**  
**Book & Page** 56921/ 151  
**Sale Date** 05/31/2011  
**Instrument** 00

## Ownership History

Ownership History					
Owner	Sale Price	Certificate	Book & Page	Instrument	Sale Date
DANGERFIELD ANTHONY	\$99,000		56921/ 151	00	05/31/2011
BEAUDET DOUGLAS S	\$480,000		54931/ 211	1P	07/01/2010

## Building Information

### Building 1 : Section 1

**Year Built:** 2010  
**Living Area:** 207  
**Replacement Cost:** \$139,353  
**Building Percent Good:** 90  
**Replacement Cost**  
**Less Depreciation:** \$125,400

Building Attributes	
Field	Description
STYLE	Retail Condo

# 61 ROSELAND ST #2

**Location** 61 ROSELAND ST #2

**Mblu** 31/ B/ 5/ 2/

**Acct#** 20131110

**Owner** BROWN JEFFREY L TRUSTEE

**Assessment** \$74,700

**PID** 110219

**Building Count** 1

## Current Value

Assessment			
Valuation Year	Improvements	Land	Total
2023	\$74,700	\$0	\$74,700

## Owner of Record

**Owner** BROWN JEFFREY L TRUSTEE  
**Co-Owner** SPRING MOUNTAIN REALTY TRUST  
**Address** 61 ROSELAND ST 2  
 SOMERVILLE, MA 02143

**Sale Price** \$72,500  
**Certificate**  
**Book & Page** 70679/ 238  
**Sale Date** 02/28/2018  
**Instrument** 00

## Ownership History

Ownership History					
Owner	Sale Price	Certificate	Book & Page	Instrument	Sale Date
BROWN JEFFREY L TRUSTEE	\$72,500		70679/ 238	00	02/28/2018
TRINCA LLC	\$40,000		58601/ 250	00	03/02/2012
BEAUDET DOUGLAS S	\$480,000		54931/ 211	1P	07/01/2010
WOMANS MENTAL HEALTH COLLECTIVE INC	\$65,000		13698/ 567	1K	05/25/1979

## Building Information

### Building 1 : Section 1

**Year Built:** 2010  
**Living Area:** 135  
**Replacement Cost:** \$82,980  
**Building Percent Good:** 90  
**Replacement Cost**  
**Less Depreciation:** \$74,700

Building Attributes

# 61 ROSELAND ST #3

Location 61 ROSELAND ST #3

Mblu 31/ B/ 5/ 3/

Acct# 20131120

Owner BROWN JEFFREY L TRUSTEE

Assessment \$84,800

PID 110220

Building Count 1

## Current Value

Assessment			
Valuation Year	Improvements	Land	Total
2023	\$84,800	\$0	\$84,800

## Owner of Record

Owner BROWN JEFFREY L TRUSTEE  
Co-Owner SPRING MOUNTAIN REALTY TRUST  
Address 691 MASSACHUSETTS AVE SUITE #3  
ARLINGTON, MA 02476

Sale Price \$65,000  
Certificate  
Book & Page 57223/ 458  
Sale Date 07/29/2011  
Instrument 00

## Ownership History

Ownership History					
Owner	Sale Price	Certificate	Book & Page	Instrument	Sale Date
BROWN JEFFREY L TRUSTEE	\$65,000		57223/ 458	00	07/29/2011
BEAUDET DOUGLAS S	\$480,000		54931/ 211	1P	07/01/2010

## Building Information

### Building 1 : Section 1

Year Built: 2010  
Living Area: 140  
Replacement Cost: \$94,248  
Building Percent Good: 90  
Replacement Cost  
Less Depreciation: \$84,800

Building Attributes	
Field	Description
STYLE	Retail Condo



# 61 ROSELAND ST #4

**Location** 61 ROSELAND ST #4

**Mblu** 31/ B/ 5/ 4/

**Acct#** 20131130

**Owner** IGOE III JAMES M

**Assessment** \$125,400

**PID** 110221

**Building Count** 1

## Current Value

Assessment			
Valuation Year	Improvements	Land	Total
2023	\$125,400	\$0	\$125,400

## Owner of Record

**Owner** IGOE III JAMES M  
**Co-Owner**  
**Address** 40 SKEHAN ST  
 SOMERVILLE, MA 02143

**Sale Price** \$100,000  
**Certificate**  
**Book & Page** 56675/ 068  
**Sale Date** 03/31/2011  
**Instrument** 00

## Ownership History

Ownership History					
Owner	Sale Price	Certificate	Book & Page	Instrument	Sale Date
IGOE III JAMES M	\$100,000		56675/ 068	00	03/31/2011
BEAUDET DOUGLAS S	\$480,000		54931/ 211	1P	07/01/2010

## Building Information

### Building 1 : Section 1

**Year Built:** 2010  
**Living Area:** 204  
**Replacement Cost:** \$137,333  
**Building Percent Good:** 90  
**Replacement Cost**  
**Less Depreciation:** \$123,600

Building Attributes	
Field	Description
STYLE	Retail Condo

# 61 ROSELAND ST #5

**Location** 61 ROSELAND ST #5

**Mblu** 31/ B/ 5/ 5/

**Acct#** 20131140

**Owner** BAILEY EMILY H TRUSTEE

**Assessment** \$117,500

**PID** 110222

**Building Count** 1

## Current Value

Assessment			
Valuation Year	Improvements	Land	Total
2023	\$117,500	\$0	\$117,500

## Owner of Record

**Owner** BAILEY EMILY H TRUSTEE  
**Co-Owner** EMILY H BAILEY REVOCABLE TRUST  
**Address** 105 LEXINGTON AVE  
 CAMBRIDGE, MA 02138

**Sale Price** \$1  
**Certificate**  
**Book & Page** 73014/ 355  
**Sale Date** 07/30/2019  
**Instrument** 1F

## Ownership History

Ownership History					
Owner	Sale Price	Certificate	Book & Page	Instrument	Sale Date
BAILEY EMILY H TRUSTEE	\$1		73014/ 355	1F	07/30/2019
BAILEY EMILY H	\$215,000		66813/ 351	1G	05/03/2011
BEAUDET DOUGLAS S	\$480,000		54931/ 211	1P	07/01/2010

## Building Information

### Building 1 : Section 1

**Year Built:** 2010  
**Living Area:** 192  
**Replacement Cost:** \$129,255  
**Building Percent Good:** 90  
**Replacement Cost  
 Less Depreciation:** \$116,300

Building Attributes	
Field	Description

# 61 ROSELAND ST #6

**Location** 61 ROSELAND ST #6

**Mblu** 31/ B/ 5/ 6/

**Acct#** 20131150

**Owner** BAILEY EMILY H TRUSTEE

**Assessment** \$102,400

**PID** 110223

**Building Count** 1

## Current Value

Assessment			
Valuation Year	Improvements	Land	Total
2023	\$102,400	\$0	\$102,400

## Owner of Record

**Owner** BAILEY EMILY H TRUSTEE  
**Co-Owner** EMILY H BAILEY REVOCABLE TRUST  
**Address** 61 ROSELAND ST 6  
 SOMERVILLE, MA 02143

**Sale Price** \$1  
**Certificate**  
**Book & Page** 73014/ 355  
**Sale Date** 07/30/2019  
**Instrument** 1F

## Ownership History

Ownership History					
Owner	Sale Price	Certificate	Book & Page	Instrument	Sale Date
BAILEY EMILY H TRUSTEE	\$1		73014/ 355	1F	07/30/2019
BAILEY EMILY H	\$215,000		56813/ 351	1G	05/03/2011
BEAUDET DOUGLAS S	\$480,000		54931/ 211	1P	07/01/2010

## Building Information

### Building 1 : Section 1

**Year Built:** 2010  
**Living Area:** 169  
**Replacement Cost:** \$113,771  
**Building Percent Good:** 90  
**Replacement Cost  
 Less Depreciation:** \$102,400

Building Attributes	
Field	Description



# 61 ROSELAND ST #7

**Location** 61 ROSELAND ST #7

**Mblu** 31/ B/ 5/ 7/

**Acct#** 20131160

**Owner** WASIK MD THEODORE P

**Assessment** \$53,300

**PID** 110224

**Building Count** 1

## Current Value

Assessment			
Valuation Year	Improvements	Land	Total
2023	\$53,300	\$0	\$53,300

## Owner of Record

**Owner** WASIK MD THEODORE P  
**Co-Owner** DECHERT MD TRACEY A  
**Address** 29 ALBION PL  
 CHARLESTOWN, MA 02129

**Sale Price** \$150,000  
**Certificate**  
**Book & Page** 57090/ 481  
**Sale Date** 07/01/2011  
**Instrument** 1V

## Ownership History

Ownership History					
Owner	Sale Price	Certificate	Book & Page	Instrument	Sale Date
WASIK MD THEODORE P	\$150,000		57090/ 481	1V	07/01/2011
BEAUDET DOUGLAS S	\$480,000		54931/ 211	1P	07/01/2010

## Building Information

### Building 1 : Section 1

**Year Built:** 2010  
**Living Area:** 88  
**Replacement Cost:** \$59,242  
**Building Percent Good:** 90  
**Replacement Cost**  
**Less Depreciation:** \$53,300

Building Attributes	
Field	Description
STYLE	Retail Condo

# 61 ROSELAND ST #8

**Location** 61 ROSELAND ST #8

**Mblu** 31/ B/ 5/ 8/

**Acct#** 20131170

**Owner** WASIK MD THEODORE P

**Assessment** \$131,500

**PID** 110225

**Building Count** 1

## Current Value

Assessment			
Valuation Year	Improvements	Land	Total
2023	\$131,500	\$0	\$131,500

## Owner of Record

**Owner** WASIK MD THEODORE P  
**Co-Owner** DECHERT MD TRACEY A  
**Address** 29 ALBION PL  
 CHARLESTOWN, MA 02129

**Sale Price** \$150,000  
**Certificate**  
**Book & Page** 57090/ 481  
**Sale Date** 07/01/2011  
**Instrument** 1V

## Ownership History

Ownership History					
Owner	Sale Price	Certificate	Book & Page	Instrument	Sale Date
WASIK MD THEODORE P	\$150,000		57090/ 481	1V	07/01/2011
BEAUDET DOUGLAS S	\$480,000		54931/ 211	1P	07/01/2010

## Building Information

### Building 1 : Section 1

**Year Built:** 2010  
**Living Area:** 217  
**Replacement Cost:** \$146,085  
**Building Percent Good:** 90  
**Replacement Cost**  
**Less Depreciation:** \$131,500

Building Attributes	
Field	Description
STYLE	Retail Condo

# 61 ROSELAND ST #9

**Location** 61 ROSELAND ST #9

**Mblu** 31/ B/ 5/ 9/

**Acct#** 20131180

**Owner** LANGOSY ZOE TRUSTEE

**Assessment** \$115,200

**PID** 110226

**Building Count** 1

## Current Value

Assessment			
Valuation Year	Improvements	Land	Total
2023	\$115,200	\$0	\$115,200

## Owner of Record

**Owner** LANGOSY ZOE TRUSTEE  
**Co-Owner** TN TRUST  
**Address** 147 SHERMAN ST. APT 103  
 CAMBRIDGE, MA 02140

**Sale Price** \$100,000  
**Certificate**  
**Book & Page** 58147/ 509  
**Sale Date** 12/22/2011  
**Instrument** 00

## Ownership History

Ownership History					
Owner	Sale Price	Certificate	Book & Page	Instrument	Sale Date
LANGOSY ZOE TRUSTEE	\$100,000		58147/ 509	00	12/22/2011
BEAUDET DOUGLAS S	\$480,000		54931/ 211	1P	07/01/2010

## Building Information

### Building 1 : Section 1

**Year Built:** 2010  
**Living Area:** 186  
**Replacement Cost:** \$125,216  
**Building Percent Good:** 92  
**Replacement Cost**  
**Less Depreciation:** \$115,200

Building Attributes	
Field	Description
STYLE	Retail Condo



# 61 ROSELAND ST #10

**Location** 61 ROSELAND ST #10

**Mblu** 31/ B/ 5/ 10/

**Acct#** 20131190

**Owner** GOTTLIEB JENNIFER & JOHN

**Assessment** \$114,400

**PID** 110227

**Building Count** 1

## Current Value

Assessment			
Valuation Year	Improvements	Land	Total
2023	\$114,400	\$0	\$114,400

## Owner of Record

**Owner** GOTTLIEB JENNIFER & JOHN  
**Co-Owner**  
**Address** 401 WASHINGTON ST  
 SOMERVILLE, MA 02143

**Sale Price** \$80,000  
**Certificate**  
**Book & Page** 58525/ 015  
**Sale Date** 02/25/2011  
**Instrument** 00

## Ownership History

Ownership History					
Owner	Sale Price	Certificate	Book & Page	Instrument	Sale Date
GOTTLIEB JENNIFER & JOHN	\$80,000		58525/ 015	00	02/25/2011
BEAUDET DOUGLAS S	\$480,000		54931/ 211	1P	07/01/2010

## Building Information

### Building 1 : Section 1

**Year Built:** 2010  
**Living Area:** 124  
**Replacement Cost:** \$114,352  
**Building Percent Good:** 100  
**Replacement Cost**  
**Less Depreciation:** \$114,400

Building Attributes	
Field	Description
STYLE	Retail Condo



# City of Cambridge

MASSACHUSETTS

## BOARD OF ZONING APPEAL

831 Mass Avenue, Cambridge, MA.  
(617) 349-6100

BZA

### POSTING NOTICE – PICK UP SHEET

*2 Bds*

The undersigned picked up the notice board for the Board of Zoning Appeals Hearing.

Name: Andrew Gorham Date: 10/10/23  
(Print)

Address: 1815 Mass Ave

Case No. BZA-243960

Hearing Date: 10/26/23

Thank you,  
Bza Members



---

**CITY OF CAMBRIDGE**  
Community Development Department

---

**IRAM FAROOQ**  
Assistant City Manager for  
Community Development

**SANDRA CLARKE**  
Deputy Director  
Chief of Administration

To: Planning Board

From: CDD Staff

Date: October 18, 2023

Re: **Cellular Antenna BZA-243960: 1815 Massachusetts Avenue**

The proposal involves an expansion of the existing wireless antenna installation at Lesley University, 1815 Massachusetts Avenue. The additional infrastructure includes:

- Three (3) exterior building-mounted panel antennas (one antenna per sector), two on the lower portion of the tower along the north and south elevations, and one in the upper middle of the west (Massachusetts Avenue facing) façade.
- Six (6) Remote Radio Units and three (3) Over Voltage Protection Devices. The proposal narrative describes these as externally mounted, however the plans and elevations both depict and note them as internally mounted and therefore not visible from the public right of way.
- Equipment to be installed on a platform on the roof of the building, which will not be visible from the public right of way.

Over the last several years, this installation has been before the Planning Board on numerous occasions. It is utilized by multiple carriers and is visually prominent from several vantage points, including Massachusetts Avenue and surrounding neighborhoods. The three proposed antennas add to an already dense clustering of communications infrastructure, and every effort should be made to reduce their individual and collective visual impact.

The following are specific suggestions to help minimize the visibility of the installation:

1. Utilize the smallest mounting brackets available so that the antennas can be mounted as close as possible to the façade surface.
2. The two lower antennas should be vertically adjusted downward so they do not visually interrupt the gray stone cornice of the building when viewed from Massachusetts Avenue.
3. The proposed Alpha Sector Antenna should be moved as far east as possible (similar to the proposed Beta Sector Antenna) to reduce its visibility from Massachusetts Avenue.

---

344 Broadway  
Cambridge, MA 02139  
Voice: 617 349-4600  
Fax: 617 349-4669  
TTY: 617 349-4621  
[www.cambridgema.gov](http://www.cambridgema.gov)

---



4. The vertical location of the single upper antenna should ensure it visually falls completely within the dark red zone to which it is mounted when viewed from Massachusetts Avenue.
5. Paint the antennas, mounting poles, brackets, and all exposed elements to match the color and finish of the existing façade material. Do not attempt to replicate the underlying grout/mortar pattern as this can inadvertently draw unintended visual attention to the antennas.
6. Ensure all exposed cables and wires are tightly fixed to façade.



# City of Cambridge

MASSACHUSETTS

BOARD OF ZONING APPEAL

831 Mass Avenue, Cambridge, MA.  
(617) 349-6100

2023 OCT -6 AM 10:57

OFFICE OF THE CITY CLERK  
CAMBRIDGE, MASSACHUSETTS

## Board of Zoning Appeal Waiver Form

The Board of Zoning Appeal  
831 Mass Avenue  
Cambridge, MA 02139

RE: Case # BZA-243920

Address: 1815 Mass Avenue

Owner,  Petitioner, or  Representative: Michael Selan, Esq.

(Print Name)

hereby waives the required time limits for holding a public hearing as required by Section 9 or Section 15 of the Zoning Act of the Commonwealth of Massachusetts, Massachusetts General Laws, Chapter 40A. The  Owner,  Petitioner, or  Representative further hereby waives the Petitioner's and/or Owner's right to a Decision by the Board of Zoning Appeal on the above referenced case within the time period as required by Section 9 or Section 15 of the Zoning Act of the Commonwealth of Massachusetts, Massachusetts General Laws, Chapter 40A, and/or Section 6409 of the federal Middle Class Tax Relief and Job Creation Act of 2012, codified as 47 U.S.C. §1455(a), or any other relevant state or federal regulation or law.

Date: 10/5/23

Signature



**Federal Communications Commission  
Wireless Telecommunications Bureau**

**RADIO STATION AUTHORIZATION**

LICENSEE: PARKERB.COM WIRELESS L.L.C.

ATTN: JEFFREY BLUM  
PARKERB.COM WIRELESS L.L.C.  
PO BOX 6663  
ENGELWOOD, CO 80155

<b>Call Sign</b> WQZM429	<b>File Number</b>
<b>Radio Service</b> WT - 600 MHz Band	

FCC Registration Number (FRN): 0025268459

<b>Grant Date</b> 06-14-2017	<b>Effective Date</b> 06-14-2017	<b>Expiration Date</b> 06-14-2029	<b>Print Date</b>
<b>Market Number</b> PEA005	<b>Channel Block</b> F	<b>Sub-Market Designator</b> 0	
<b>Market Name</b> Baltimore, MD-Washington, DC			
<b>1st Build-out Date</b> 06-14-2023	<b>2nd Build-out Date</b>	<b>3rd Build-out Date</b>	<b>4th Build-out Date</b>

**Waivers/Conditions:**  
NONE

**Conditions:**  
Pursuant to §309(h) of the Communications Act of 1934, as amended, 47 U.S.C. §309(h), this license is subject to the following conditions: This license shall not vest in the licensee any right to operate the station nor any right in the use of the frequencies designated in the license beyond the term thereof nor in any other manner than authorized herein. Neither the license nor the right granted thereunder shall be assigned or otherwise transferred in violation of the Communications Act of 1934, as amended. See 47 U.S.C. § 310(d). This license is subject in terms to the right of use or control conferred by §706 of the Communications Act of 1934, as amended. See 47 U.S.C. §606.

This license may not authorize operation throughout the entire geographic area or spectrum identified on the hardcopy version. To view the specific geographic area and spectrum authorized by this license, refer to the Spectrum and Market Area information under the Market Tab of the license record in the Universal Licensing System (ULS). To view the license record, go to the ULS homepage at <http://wireless.fcc.gov/uls/index.htm?job=home> and select "License Search". Follow the instructions on how to search for license information.

**Licensee Name:** PARKERB.COM WIRELESS L.L.C.

**Call Sign:** WQZM429

**File Number:**

**Print Date:**

**700 MHz Relicensed Area Information:**

<b>Market</b>	<b>Market Name</b>	<b>Buildout Deadline</b>	<b>Buildout Notification</b>	<b>Status</b>
---------------	--------------------	--------------------------	------------------------------	---------------

Official Copy





**Federal Communications Commission  
Wireless Telecommunications Bureau**

**RADIO STATION AUTHORIZATION**

LICENSEE: PARKERB.COM WIRELESS L.L.C.

ATTN: JEFFREY BLUM  
PARKERB.COM WIRELESS L.L.C.  
PO BOX 6663  
ENGELWOOD, CO 80155

<b>Call Sign</b> WQZM430	<b>File Number</b>
<b>Radio Service</b> WT - 600 MHz Band	

FCC Registration Number (FRN): 0025268459

<b>Grant Date</b> 06-14-2017	<b>Effective Date</b> 06-14-2017	<b>Expiration Date</b> 06-14-2029	<b>Print Date</b>
<b>Market Number</b> PEA005	<b>Channel Block</b> G	<b>Sub-Market Designator</b> 0	
<b>Market Name</b> Baltimore, MD-Washington, DC			
<b>1st Build-out Date</b> 06-14-2023	<b>2nd Build-out Date</b>	<b>3rd Build-out Date</b>	<b>4th Build-out Date</b>

**Waivers/Conditions:**

NONE

**Conditions:**

Pursuant to §309(h) of the Communications Act of 1934, as amended, 47 U.S.C. §309(h), this license is subject to the following conditions: This license shall not vest in the licensee any right to operate the station nor any right in the use of the frequencies designated in the license beyond the term thereof nor in any other manner than authorized herein. Neither the license nor the right granted thereunder shall be assigned or otherwise transferred in violation of the Communications Act of 1934, as amended. See 47 U.S.C. § 310(d). This license is subject in terms to the right of use or control conferred by §706 of the Communications Act of 1934, as amended. See 47 U.S.C. §606.

This license may not authorize operation throughout the entire geographic area or spectrum identified on the hardcopy version. To view the specific geographic area and spectrum authorized by this license, refer to the Spectrum and Market Area information under the Market Tab of the license record in the Universal Licensing System (ULS). To view the license record, go to the ULS homepage at <http://wireless.fcc.gov/uls/index.htm?job=home> and select "License Search". Follow the instructions on how to search for license information.

Licensee Name: PARKERB.COM WIRELESS L.L.C.

Call Sign: WQZM430

File Number:

Print Date:

700 MHz Relicensed Area Information:

Market	Market Name	Buildout Deadline	Buildout Notification	Status
--------	-------------	-------------------	-----------------------	--------

Official Copy