

Eastern Cambridge Design Guidelines: North Point



December 2003

north
point

EASTERN CAMBRIDGE DESIGN GUIDELINES: NORTH POINT

INTRODUCTION

The layout of the new North Point neighborhood is driven in large part by the desire to structure a contiguous internal public realm, which is well integrated into the surrounding neighborhoods. The streets, sidewalks, boulevard, central park, and green fingers are designed to hold together as a single network, while providing formal and functional variety. The tight city block structure sets up an urban streetscape to create a hierarchy of uses, clarity of circulation, human scale and an animated public and pedestrian realm. Short blocks, along with buildings exhibiting a diversity of architectural expression, establish a comfortable pedestrian scale common to all building types, framing streets with minimal setbacks and enlivening the sidewalks with entrances, life, and activity.

Design principles used to create the North Point Master Plan emphasize a variety of scale and form to reflect a diversity of experience throughout the 45-acre site. Each parcel is intended to relate to its immediate surroundings as well as the larger context. The larger context is defined by overall image, legibility, cohesiveness, scale, character, connections, and movement. Local context determinants include orientation, solar exposure, parking, views to the surroundings and the central park, definition of un-built open spaces, public-private hierarchy, strategic location/program/opportunity, integration of multiple uses and interface with transit. This urban design framework builds on the *Eastern Cambridge Design Guidelines* and sets out the basic parameters, which will shape built form.

Attached are the *Eastern Cambridge Design Guidelines: North Point* ("North Point Guidelines"). These guidelines are based on the *Eastern Cambridge Design Guidelines* for the entire Eastern Cambridge area developed by the City of Cambridge and the ECaPS Committee. The *North Point Guidelines* reflect the *Eastern Cambridge Guidelines*, but are specific to the North Point area and provide additional illustration of design components that may be applicable to North Point.

PURPOSE

These *Eastern Cambridge Design Guidelines: North Point* provide a framework for the design of a livable mixed-use community and will be provided to architects as North Point buildings are designed. These guidelines will be provided to architects of each building or other public space as they are chosen to guide them in their design efforts. The guidelines represent a consensus of attitude regarding the development of the North Point site as derived through several years of planning in East Cambridge by the City of Cambridge, the *Eastern Cambridge Design Guidelines* as well as the project specific permitting and community outreach processes for the North Point site. In addition, these guidelines are consistent with the parameters of the Special Permit issued by the Cambridge Planning Board in March 2003.

It is understood that the application of these principles, including numerical guidelines, can vary with the context of specific building proposals in ways that, nevertheless, fully respect the policies' intent. It is intended that proponents of projects and city staff, the Planning Board and the general public, where public review or approval is required, should be open to creative variations from the detailed provisions presented herein as long as the core values expressed are being served.

The attached guidelines consist of four components as described below. Architects and reviewers should refer to additional documents including: the Planning Board Special Permit for North Point and a Memo from Ralph Cox to the Cambridge Planning Board regarding civic uses (both attached on the following pages), and the roadway Network Schematic Plan that will be submitted to the Planning Board for review and approval prior to the issuance of a building permit for the first building at the site.

Part 1: Guidelines Text

The Guidelines Text is based on the *Eastern Cambridge Design Guidelines* developed by the City of Cambridge. It provides the dimensional guidelines that should drive the design of buildings and other public spaces at North Point. The Guidelines Text is the controlling component of this guideline package and where there are discrepancies between the guidelines and Catalog of Images or Specific Block Guidelines, the Guidelines Text will rule.

Part 2: Catalog of Images

The Catalog of Images consists of graphics that illustrate the concepts described in the Guidelines Text. They are referenced throughout the Guidelines Text as Exhibits 1 –19.

Part 3: Specific Block Guidelines

The North Point team has developed examples of how the guidelines are applied to each building block. These will be provided to each building architect and include approximate size, height and use of the buildings on each block, as well as recommended locations for pedestrian and vehicular entries. The Specific Block Guidelines also highlight the unique characteristics particular to each block of which architects should be aware. These may include items such as proximity to the Central Park, integration with the MBTA transit station or requirement for a connection to the Gilmore Bridge.

Part 4: Model Images

The Model Images consists of graphics that illustrate the North Point Model from different viewing perspectives.

SPAULDING & SLYE



Memorandum

To: Tom Anninger, Chair Cambridge Planning Board
From: Ralph Cox
Date: 12/10/03
Re: North Point Design Guidelines

At the Tuesday December 2, 2003 Planning Board Meeting, the North Point Cambridge Land Company (NPCLC) presented the *Eastern Cambridge Design Guidelines: North Point* to the board for review and approval. At the meeting, the North Point team was asked about our commitment to the development of civic amenities at North Point. As I responded at the time, we believe that the inclusion of cultural and civic amenities at North Point will provide a sense of place, contribute to a lively community, and add value at North Point.

Through and following the special permit process, the North Point team has preliminarily investigated a number of opportunities for civic and cultural amenities. Lisa Serafin, a Vice President at Spaulding & Slye Colliers and a member of the North Point team, is a Museum of Science board member and has assembled a committee of Science Museum representatives and project team members to identify ways to strengthen connections between the two. Ideas could include indoor or outdoor exhibit space. Likewise, we have been in touch with a museum of national reputation to discuss their interest in locating a branch museum at North Point. Although at the present time, the economy and its impact on museum attendance does not support this type of expansion, the concept is regarded favorably and is likely to be viable at some point during the growth of North Point. We have also discussed and explored ways to incorporate art into the site through ground floor gallery space or a sculpture park along the community path and through the Central Park.

We recognize that the most appropriate civic amenities will reveal themselves over time and we look forward to continuing to work with the Planning Board, the City of Cambridge and the community to make them a reality.

Eastern Cambridge Design Guidelines: North Point

**EASTERN CAMBRIDGE DESIGN GUIDELINES: NORTH POINT
PART 1: GUIDELINES TEXT**

I. GOALS FOR NORTH POINT

- Create a lively new mixed-use district with strong visual and pedestrian connections to East Cambridge. The new district should be a place to live, work, and enjoy a variety of parks and public spaces.
- Create a new east-west main street through the center of North Point, connecting East Cambridge with the future MDC Park
- Extend First Street into North Point to connect existing and new neighborhoods.
- Create a major new public park easily accessible from the relocated Lechmere T station, First Street, and O'Brien Highway.
- Create a new retail edge at the relocated Lechmere T station and at the intersection of First Street, Cambridge Street, and O'Brien Highway that will complement, not compete with, existing retail on Cambridge Street.

EXHIBIT 1, LAND USE PLAN, provides a diagrammatic representation of the North Point master plan approved by the Planning Board. In addition, the Land Use Plan provides some understanding of the distinction between the block types discussed in later sections. However, the categorization of blocks may change pursuant to the Special Permit granted by the Planning Board.

II. BUILT FORM

A. STREET-LEVEL USES AND DESIGN

Residential Blocks

Residential blocks are blocks that are primarily lined with housing (shown on Exhibit 1 as Blocks A, B, C, D, E, F, I, J, and T). Residential blocks will include a variety of housing types including lofts, townhouses, and apartments. Corner retail is allowed and even encouraged in some residential blocks, where appropriate.

Building Design should be consistent with the following principles:

- Create a consistent residential edge, with small setbacks for stoops, porches, and front gardens. Residential design is encouraged to have multiple entrances to the street.

- Buildings should be designed with individual units and front doors facing the street, including row house units on the lower levels of multi-family buildings. Where residential lobbies face the street, doors should generally be spaced no more than 75 feet apart.
- Blank walls should be avoided along all streets and pedestrian walkways.
- Multiple windows at the ground level are encouraged to allow "eyes on the street"
- Courtyards and open spaces are encouraged to have maximum sun exposure.

EXHIBIT 2, RESIDENTIAL MASSING, shows examples of residential massings that may be appropriate to North Point. Articulated massing for higher rise buildings are shown in photos 4 and 6. Articulated massing for low-rise buildings are shown in photos 1, 2, 3, and 7. Photo 5 provides an example of a loft building design.

EXHIBIT 3, RESIDENTIAL FAÇADE DETAILS shows how residential fenestration details including multiple windows, bay windows, balconies can be used to provide visual interest for external viewers, "eyes on the street" enhancement to public realm security, views and sun exposure for internal residents and the extension of the private realm into public space through the use of balconies and roof terraces.

EXHIBIT 4, RESIDENTIAL ENTRIES AND STOOPS show how well designed residential entries and stoops can provide successful transitions between public and private realms, act as clearly marked and identifiable pedestrian entrances, and provide visual interest through a variety of ground plane projections like canopies, awnings and signage.

Mixed-use Blocks or Commercial Blocks

Mixed-use Blocks or Commercial Blocks are blocks that include housing and/or commercial uses, with a mix of active uses strongly encouraged on the ground floor. (Mixed-use Blocks may include K, L, M, Q, V and S or as otherwise permitted pursuant to the Special Permit. Commercial Blocks are G, H, N, U and R or as otherwise permitted pursuant to the Special Permit.)

New development on mixed-use or commercial blocks should be consistent with the following principles:

- Street-level facades should include active uses such as:
 - Residential entrances
 - Shops, restaurants, and cafes
 - Services for the public or for commercial offices such as fitness centers, cafeterias, daycare centers, etc.
 - Community spaces, such as exhibition or meeting space
 - Art exhibition space/display windows
 - Commercial lobbies and front doors
- Office/ R&D uses are discouraged from occupying extensive ground-floor frontage. Where these uses do occur, they should occupy no more than 200 to 250 feet of continuous frontage along public streets.
- Ground floor frontage should generally be permeable and visually articulated as several smaller masses.
- Major entrances should be located on public streets, and at or near corners wherever possible. Entrances should relate well to crosswalks and pathways that lead to bus stops and transit stations.
- Buildings should have a carefully articulated base of one or two floors with high level of transparency and lightness (30-50 percent transparent) at the ground floors allowing views inward and outward. Numerous entrances along principal pedestrian routes are encouraged both for safety and to enhance the pedestrian environment.
- Blank walls should be avoided along all public streets, courts, and pedestrian walkways.

EXHIBIT 5, OFFICE MASSINGS shows examples of office building massings that may be appropriate to North Point.

EXHIBIT 6, OFFICE FAÇADE DETAILS shows how successful office façade design includes a variety of materials, transparency, lightness, massing, visual interest and functionality.

EXHIBIT 7, OFFICE ENTRIES shows how well-designed office entries provide critical transitional elements between public and private realms. Desirable elements include transparent and lit entrance facades, clearly marked and identifiable pedestrian entrances, and a variety of ground plane projections like canopies, awnings

and signage. Well designed office entries create interest for pedestrians and animates the street facades and corners.

EXHIBIT 8, MIXED USE MASSING provides additional examples of successful massing of mixed-use buildings (those including both commercial and residential components).

Retail Blocks

Retail Blocks are blocks that include either commercial or residential uses on upper floors, with retail strongly encouraged on the ground floor. Retail blocks are intended to have a high volume of pedestrian traffic, and to support public activity throughout the day and evening. (Blocks where retail is strongly encouraged include H, M, N, Q, R and V, and may include others pursuant to the Special Permit.)

Retail block development should be consistent with the following principles:

- At least 75 percent of the street frontage should be occupied by retail uses, including cafes and restaurants.
- The amount and scale of retail uses will serve both the residents and tenants within North Point. The retail entities will be located at the most critical locations within the development.
- Major entrances should be located on public streets, and on corners wherever possible. Entrances should relate to crosswalks and pathways that lead to bus stops and transit stations.
- Retail venues within North Point should be as transparent as possible to maximize visibility of street level uses. Ground floor facades should permit a clear view from the sidewalk to the interior space of the building (at least 50-75% transparent surface).
- Blank walls should be avoided along all public streets, courts, and pedestrian walkways.

EXHIBIT 9, RETAIL STORE FRONTS illustrates that successful retail store fronts include awnings, canopies and other elements to animate the street façade, provide individual identity for retailers and provide articulation at the ground plane.

B. BUILDING HEIGHT AND ORIENTATION

EXHIBIT 10 illustrates the Zoning Heights applicable to North Point.

EXHIBIT 11 illustrates the framework hierarchy of streets that provides the foundation for the Roadway Network Schematic Plan.

Major Public Streets

At North Point major public streets include Msgr. O'Brien Highway; Cambridge Street; and First Street (including the extension into North Point). Development along major public streets should be consistent with the following principles:

- Set back any portion of the building above 65 feet by at least 10 feet from the principal facade.
- Use architectural expression on any portion of the building above 65 feet to prevent continuous massing. Buildings should have a clearly expressed base, middle, and top. This may be achieved through changes in material, fenestration, architectural detailing, or other elements.
- For retail and office uses, build to the lot line or provide small setbacks (5 to 15 feet) from the right-of-way for café seating, benches, or small open spaces. Setbacks may be allowed to accommodate street furniture, street trees, or generous sidewalks. Awnings and canopies are encouraged to provide shelter and enliven the ground floor facade.
- For residential uses, provide small setbacks (5 to 10 feet) for stoops, porches, and front gardens. Front stoops and porches may not be feasible while providing handicap accessibility. In such cases, the provision of small setbacks for front gardens is highly encouraged.
- Driveway turnaround and vehicle drop-off facilities are strongly discouraged along public streets.
- Locate loading docks on side streets or service alleys, and away from residential areas. Corner articulation of buildings is encouraged.

Neighborhood Streets

At North Point, new residential streets will be created and will include North Street and South Street. Development along neighborhood streets should be consistent with the following principles:

- **Set back any portion of the building above 45 feet by at least 10 feet from the principal facade. Where**

appropriate, design these setbacks to include balconies and rooftop terraces.

- Use architectural expression on any portion of the building above 65 feet to prevent continuous massing. Buildings should have a clearly expressed base, middle, and top. This may be achieved through changes in material, fenestration, architectural detailing, or other elements such as balconies and rooftop terraces.
- Buildings should have individual entrances on the first floor directly opening onto the streets and front doors facing the streets **with small setbacks (5 to 10 feet) for stoops, porches, and front gardens.**
- Locate courtyards and open spaces to maximize sun exposure.

Park Edges

At North Point, new streets facing a public park will be created and will include South Park Street and North Park Street. Development along park edges should be consistent with the following principles:

- The Central Park, Green Fingers, and West Boulevard are the unifying elements of the public realm in the North Point neighborhood. Buildings on parcels facing these open spaces are encouraged to maintain consistent massing and scale that is required for the success of these open spaces. (A useful benchmark suggested in the Eastern Cambridge Design Guidelines is that the height of the principal façade of buildings surrounding a park should be no greater than 1/3 the width of the park. For additional height above this limit, buildings should be stepped back by at least ten feet from the principal façade). Greater height without setbacks may, however, be appropriate at corners or in specific locations to create architectural variety. The buildings must conform to overall district height limits in the zoning. Exceptions from the height limits can be sought where appropriate to improve the quality of urban design and the public realm while working within the spirit of the zoning.
- Locate buildings to minimize shadows on the park, especially in the afternoon.
- Surround public parks with uses that create an active environment throughout the day and evening and increase safety for park users, such as:
- Buildings should be designed with individual units and front doors facing the street, including row house units on the lower levels of multi-family buildings. Where residential

lobbies face the street, doors should generally be spaced no more than 75 feet apart.

- Shops, cafés and other public uses that enliven the street.

Other Streets

- To the extent that there is an existing urban context (such as for Building V), North Point buildings should relate to the prevailing height of surrounding buildings, that are 65 feet or less, and establish a cornice line that respects the prevailing height of those surrounding buildings. For additional height above the cornice line, provide a setback from the principal façade or other architectural detailing.
- For retail and office uses, build to the lot line or provide small setbacks (5 to 15 feet) from the right-of-way for café seating, benches, or small open spaces. Setbacks used exclusively for ornamental landscaping are not permitted.
- **For residential uses**, buildings should have individual entrances on the first floor directly opening onto the streets and front doors facing the streets **with small setbacks (5 to 10 feet) for stoops, porches, and front gardens. Front stoops and porches may not be feasible while meeting accessibility requirements. In such cases, the provision of small setbacks for front gardens is highly encouraged.**
- Locate loading docks on side streets or service alleys, and away from residential areas.

C. SCALE AND MASSING

- The layout of the new North Point neighborhood is driven in large part by the desire to structure contiguous internal public realm, which is also well integrated into with the surrounding neighborhoods.
- Orientation of buildings is suggested to take advantage of exposure to sun and views to the green spaces and surrounding attractions.
- Buildings should avoid continuous massing longer than 100 feet facing residential streets and 200 feet facing mixed-use and retail streets. If massing extends beyond this length, it should be made permeable and visually articulated as several smaller masses using different materials or colors, vertical breaks, bays, or other architectural elements.
- In addition to the above limits, buildings should reflect a rhythm and variation appropriate to the urban context. For example, this can be achieved by expressing bay

widths of 16 to 25 feet along residential streets and 25 to 50 feet along mixed-use and retail streets.

- Buildings should have a clearly expressed base, middle, and top. This may be achieved through a variety of materials, fenestration, architectural detailing, massing, or other elements. In order to achieve this, the following principles should be considered:
 - Buildings should have a carefully articulated base of one of two floors with a high level of transparency, lightness, and detail at the ground floors allowing views inward and outward.
 - A line of expression at the second floor is intended to humanize the scale of the buildings and create an intimate pedestrian experience. This should be achieved by means of material articulation or architectural detailing.
 - The mid section of the building is recommended to be up to 3-6 stories to allow for light penetration, continuity and consistency of built mass while allowing for individual architectural detailing.
 - The base and middle should be built to the street line with limited courtyard openings where appropriate.
 - Use variations in height and architectural elements such as parapets, cornices and other details to create interesting and varied rooflines and to clearly express the tops of buildings.
 - Emphasize corners using taller elements such as towers, turrets, and bays
 - Taller buildings should be articulated to avoid a monolithic appearance: This should be achieved by setting back the taller portions from the base and middle façade. Where appropriate the top sections of the buildings should be designed to emphasize variety within the development. This may include the use of, but not limited to, point towers.

EXHIBIT 12, MASSING SETBACKS illustrates a range of setbacks for tall buildings (photos 1, 2, 5, 6, 7, and 8) and shorter buildings (3 and 4).

D. ARCHITECTURAL CHARACTER

Residential

- Create varied architecture and avoid flat facades by using bays, balconies, porches, stoops, and other projecting elements.

- Maximize the number of windows facing public streets to increase safety.

Commercial

- Create varied architecture and avoid flat facades by using recessed or projected entryways, bays, canopies, awnings, and other architectural elements.
- Vary the architecture of individual buildings to create architecturally diverse districts.
- Where buildings are set back at upper stories, lower roofs may be used as balconies, balustrades, and gardens.

E. ENVIRONMENTAL GUIDELINES (LEED PRINCIPLES)

Design buildings to use natural resources and energy resources efficiently in construction, maintenance, and long-term operation of the building. Buildings on a lot should be sited to allow construction on adjacent lots to do the same. Compliance with *Leadership in Energy and Environmental Design* (LEED) certification standards and other evolving environmental efficiency standards is encouraged. Rooftop mechanical equipment should be sited and shielded to protect neighboring uses from noise impacts. Mechanical penthouses and vertical roof projections should be designed as part of each building composition.

F. PARKING

- While underground parking is preferable everywhere, if above ground parking is to be built it should be designed so as not to be visible from public streets or pathways. Above ground structured parking should be lined with active uses (shops, cafes, etc.) along major public streets, or with housing units along residential streets.
- Locate vehicular parking entrances and loading docks on side streets and alleys and provide safe pedestrian access from public streets. Where it is necessary to locate them on the major streets, building design shall try to make them unobtrusive to the pedestrian movement and shall maintain the quality of public realm.
- All parking garages must provide direct pedestrian access to the street.
- The primary pedestrian exit/access to all garages serving non-residential uses should be to the street or a public area.

- Design and locate lighting fixtures in surface parking lots and garages to enhance safety while minimizing light spillover onto adjacent properties.

EXHIBIT 13, RESIDENTIAL/HALF GRADE PARKING illustrates how parking can be integrated into residential buildings without being visible to pedestrians.

EXHIBIT 14, INTEGRATION OF ABOVE GRADE PARKING illustrates how above grade parking along the back of the North Point site (adjacent to the MBTA tracks) can be faced with residential or other active uses to shield it from pedestrian view.

EXHIBIT 15, REAR OF PARKING STRUCTURE ALONG MBTA TRACKS illustrates above grade structure designs that may be applicable to the rear of the parking structures along the MBTA tracks (not visible from within North Point).

G. PUBLIC REALM

Public Open Spaces

- The provision of open space of diverse sizes and use is encouraged to enhance the public environment at North Point.
- The provision of interconnected series of open spaces is encouraged to provide connections to neighborhoods and to encourage pedestrian movement.
- Where major new parks are required by zoning, provide programmed, multi-use open space for both recreational and cultural activities.
- The major new park required by the zoning code should be located convenient to the Lechmere T station in order to link East Cambridge and future neighborhoods at North Point.
- In addition to the required public open space, the creation of a series of smaller open spaces such as courtyards, parks, playgrounds and gardens located along the central main street is encouraged.

EXHIBIT 16, LANDSCAPE CHARACTER IMAGES illustrates the variety of activities that could occur in the public open spaces at North Point. These include passive green spaces for informal play or interaction (photos 1, 2, 3, 5, and 10), hardscape surfaces for seating and viewing activities (photos 8, 9 and 11) and paths for circulation throughout public spaces (photos 4, 6 and 7).

EXHIBIT 17, COMMUNITY, CULTURAL AND OPEN SPACE OPPORTUNITIES shows examples of the types of discrete spaces that could be incorporated into the North Point open spaces including tot lots and other small play spaces.

Semi-Private Open Spaces

- For residential development, create semi-private open spaces (e.g. front and rear yards, porches, stoops, and patios) that create a transition from public sidewalks and courts to private interior spaces.
- Design residential courtyards to be visually accessible from streets to enhance safety and activity along the street.

EXHIBIT 18, COURTYARDS AND FRONT YARDS shows how residential courtyards and front yards can be designed as semi-private space.

Streets and Sidewalks

Refer to the Cambridge Pedestrian Plan and the Cambridge Bicycle Plan for additional guidance on creating a safe and pleasant environment for pedestrians and bicyclists and for guidance on sidewalk width and street trees.

Refer to EXHIBIT 11 and the Roadway Network Schematic Plan (to be approved by the Planning Board prior to the issuance of the Building Permit for the first building) for detail on street, sidewalks, bike lanes, on-street parking and pedestrian crossings.

Character

- Use streetscape elements such as trees, benches, signage, and lighting to support active pedestrian uses and to reinforce the character and identity of each district.
- Design streets to encourage pedestrian and cycle activity, and to control vehicle speed in residential areas.
- Where appropriate, establish, preserve and highlight views from public streets and spaces to important civic landmarks such as the Charles River cable-stayed bridge and the clock tower in Kendall Square.
- In the design of new streets, provide sufficient pavement width to accommodate on-street parking where appropriate in order to provide short-term parking and to serve local retail.

- In the design of new streets, pathways, and parks, provide pedestrian-scale lighting to enhance pedestrian safety.
- Numerous entrances along principal pedestrian routes are encouraged both for safety and to enhance the pedestrian environment.
- Major entrances should be located on public streets, and at or near corners wherever possible. Entrances should relate well to crosswalks and pathways that lead to bus stops and transit stations.

Connections

- Provide safe pedestrian and bicycle connections to future regional pathways (Grand Junction railroad, North Point path).
- Provide strong pedestrian, bicycle and visual connections to the Charles River and public parks through view corridors, signage, and/or art installations.
- Provide safe pedestrian and bicycle connections to existing and new bus stops and to transit stations including Kendall Square, Lechmere, Community College and North Station MBTA stations. In particular, direct access from the residential neighborhood south of Msgr. O'Brien Highway and Cambridge Street to the new T station, if relocated, is desirable.
- Provide continuous pedestrian and bicycle access through the area to the MDC New Charles River Basin Park.
- Provide new pedestrian crossings along Msgr. O'Brien Highway with strong visual connections from existing streets in East Cambridge to new streets at North Point. Ensure that new pedestrian crossings are coordinated with traffic operations on Msgr. O'Brien Highway.
- Provide landscaped pedestrian/cycle connections from North Point to the future regional bicycle path.
- Provide for improved pedestrian and bicycle connections to and from the Orange Line T station.

H. TRANSPORTATION AND PUBLIC TRANSIT NODES

Transit

- Preserve rights of way for future Urban Ring project.
- Integrate retail and other public activities with any new transit stations.

Pedestrian

- Provide pedestrian crossings/phases at all major intersections.

Bicycle/other non-motorized vehicles

- Provide bicycle lanes on major streets.
- Provide sheltered bicycle racks in all new commercial and multi-family residential buildings and in transit stations.
- Provide bicycle racks along the street in retail areas.

EXHIBIT 19, PROTECTED BIKE RACKS AND BIKE STATIONS provides examples of bicycle amenities that could be incorporated into the North Point project.

Gilmore Bridge/Orange Line Locus

As a major vehicular transit-way and as the pedestrian connection to the Orange Line, the Gilmore Bridge affords the opportunities to make direct connection from North Point site to the Orange Line Community College MBTA Station and Charlestown beyond, thus enhancing the quality of pedestrian environment.

Building Design in the parcels that are adjacent to Gilmore Bridge should be consistent with the following principles:

- The building massing should be designed to create a character and scale keeping with the Gilmore Bridge.
- At least one of the buildings shall include a public escalator and elevator to move people from ground level to bridge level. Retail development along this edge will enhance the quality of pedestrian movement.
- The envelope guidelines require extending the public realm through the buildings to make these important connections between the Gilmore Bridge and the site.
- These commercial and retail buildings are encouraged to have a consistent edge along both the public streets at ground level and at the bridge level. Articulated entry

points and a plaza at bridge level will help integrate these buildings into the site development.

- Lightness and transparency at the ground level of the buildings are encouraged especially on the facades facing the principle public streets and green spaces.

Lechmere Square Locus

New Lechmere Square at the intersection of First Street and O'Brien Highway will form the major entry to the site. The future Green Line MBTA tracks and station may be integrated into the envelopes of some of the buildings adjoining it. The overall composition of these mixed-use parcels with the MBTA station is intended to have a "gateway" quality to celebrate this major entrance to the site. Lechmere Square also forms an entrance gateway to the Cambridge Street Retail District and the transition between East Cambridge and the site.

Building design in the parcels adjoining Lechmere Square should be consistent with the following principles:

- The buildings that define the new Lechmere Square should be set back from the street to create gracious sidewalks
- Ground level retail activity should open out onto the sidewalks to further enhance the public realm.
- The building massing should be designed to create and promote the character and scale of the proposed Lechmere Square.
- Major entrances to retail should be located on public streets, and on corners wherever possible. Entrances should relate to crosswalks and pathways that lead to bus stops and the transit station.

MBTA Facilities

Building design in the parcels adjoining the MBTA Facilities to the north of the site should be consistent with the following principles:

- Building design should consider the existing and future MBTA facilities to the north of the site.
- The orientation of buildings on the parcels abutting the MBTA tracks to the north will form a continuous sound barrier to noise generated by transit operations and I-93 beyond.

- Noise and vibration should be abated where necessary, through thoughtful design and relevant acoustical treatments.

Eastern Cambridge Design Guidelines: North Point

North Point

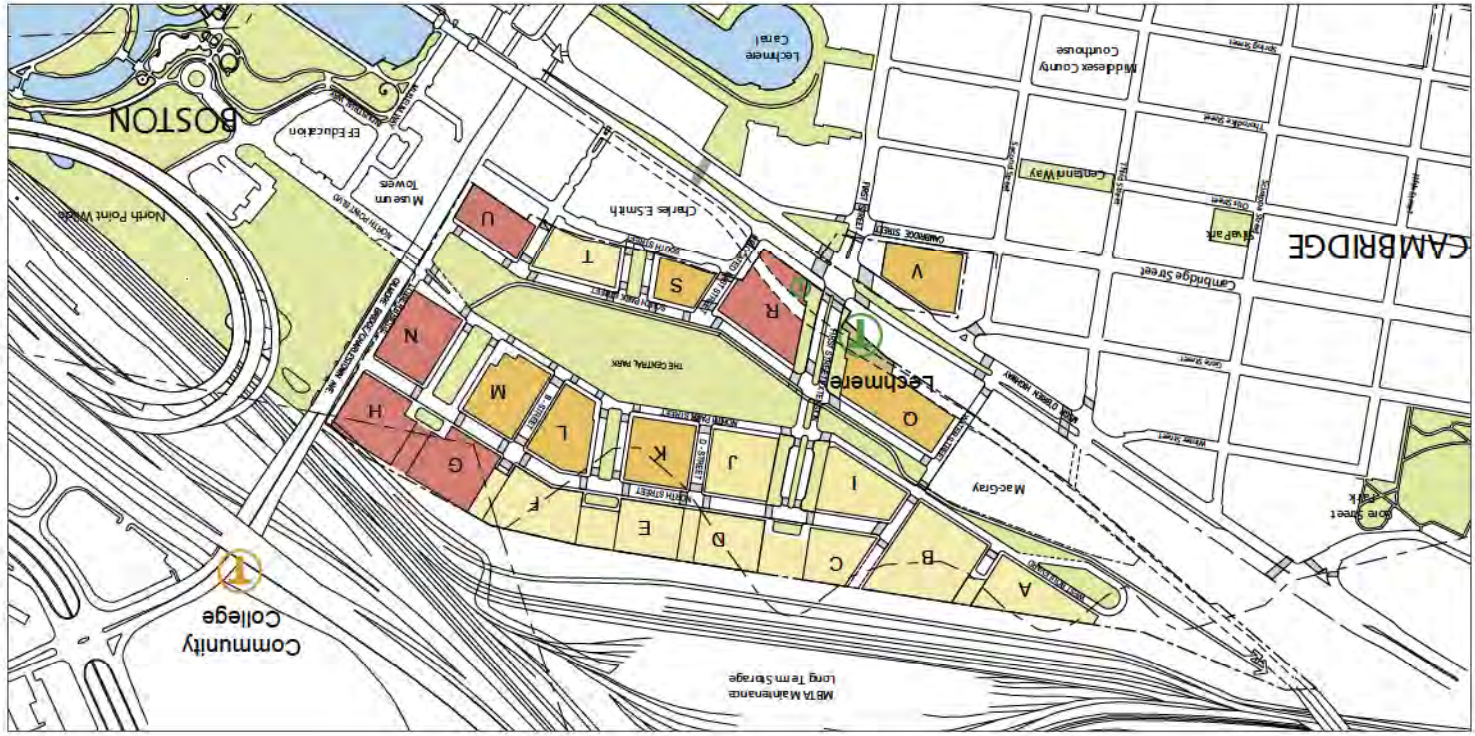

North Point

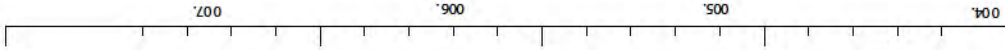
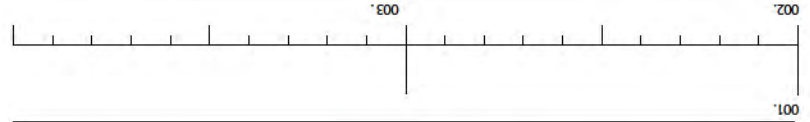
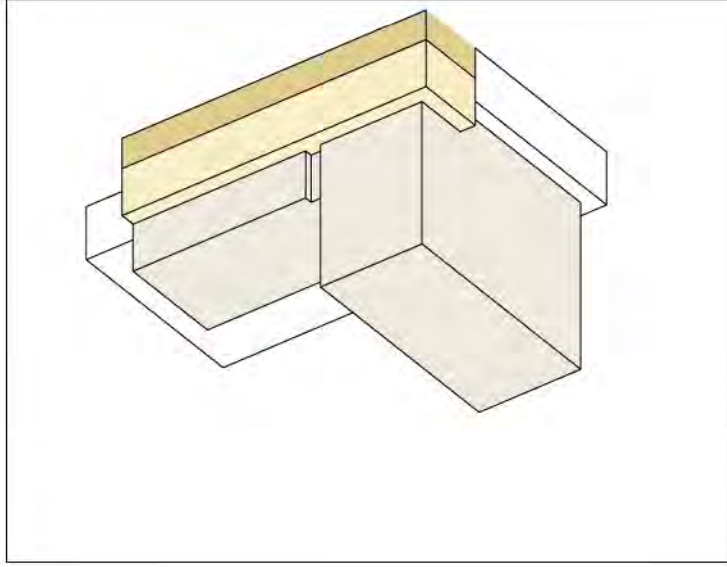

North Point

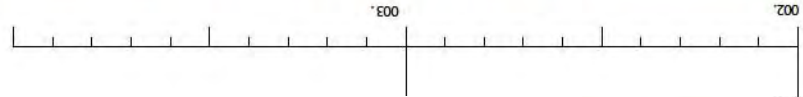
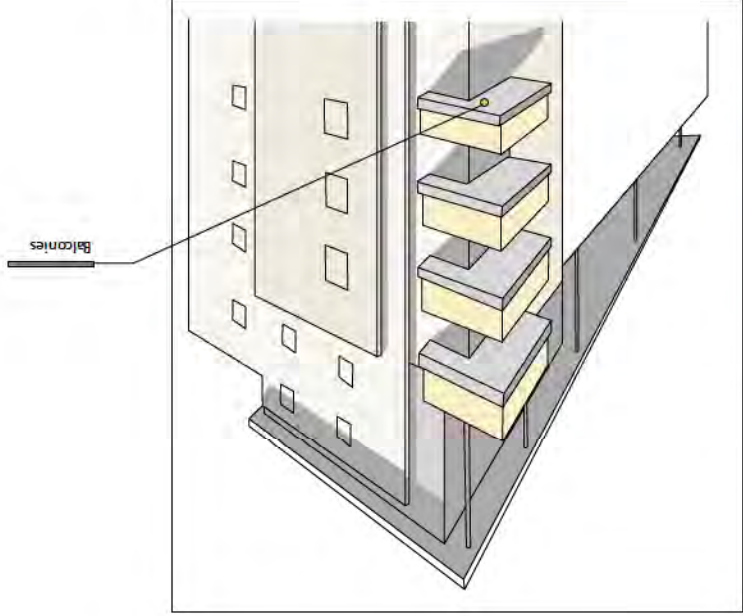

004. 005. 006. 007.

North Point



003.
004.
001.
002.



Entries/Stoops

Entries/Stoops

005.
006.
007.
008.



North Point

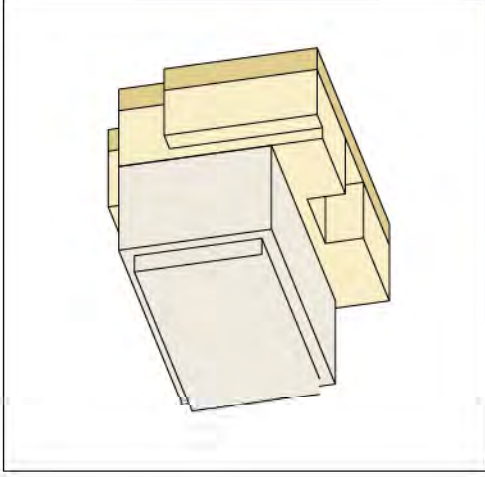

003.

002.

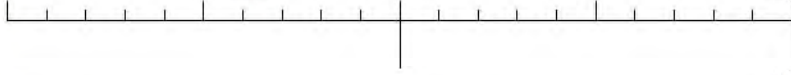

001.



004.

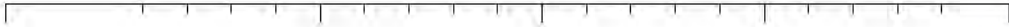

North Point

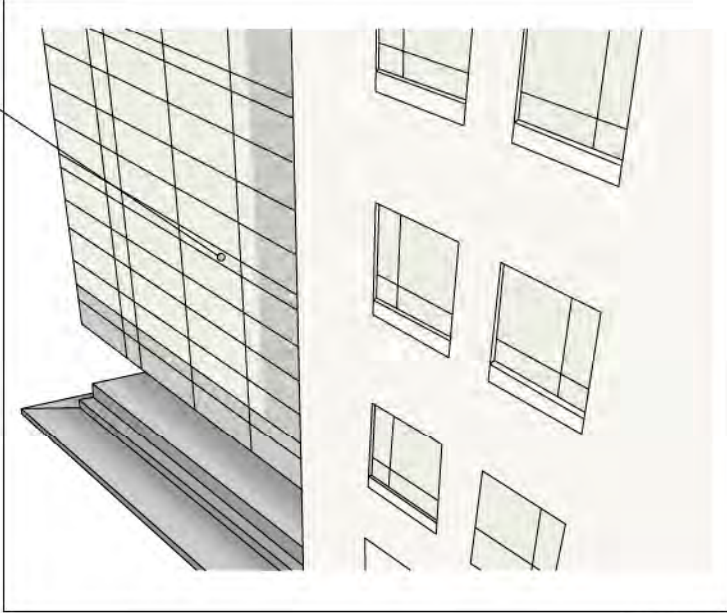

Fenestration

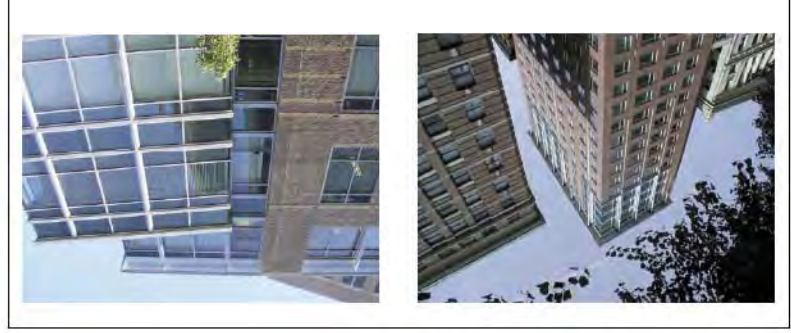

003.

002.

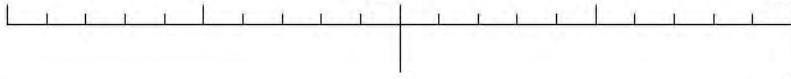

001.



007.

006.

005.

004.



North Point

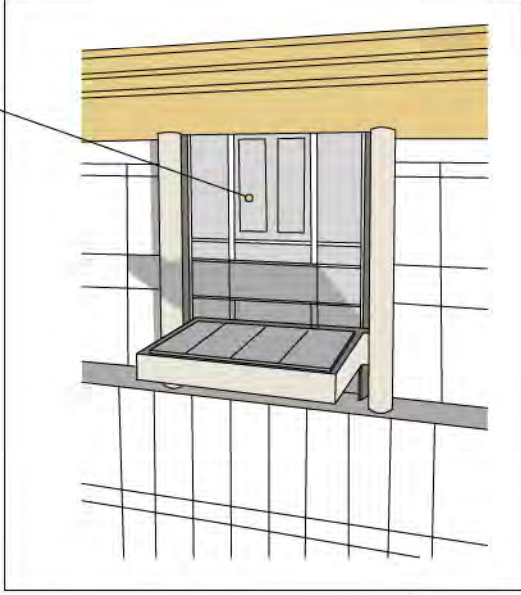

Office Entry

Entries/Stoops



003.
004.
002.
001.



005.
006.
007.
008.



North Point

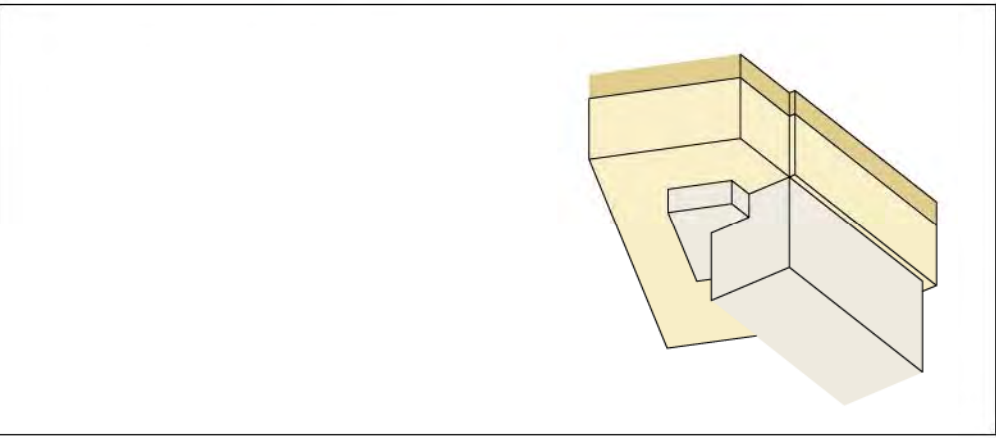

North Point



Retail Store Fronts/
Awnings/ Canopies



002. 003.

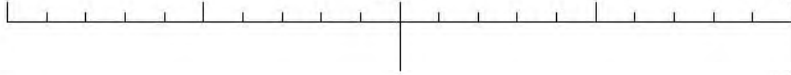

001.

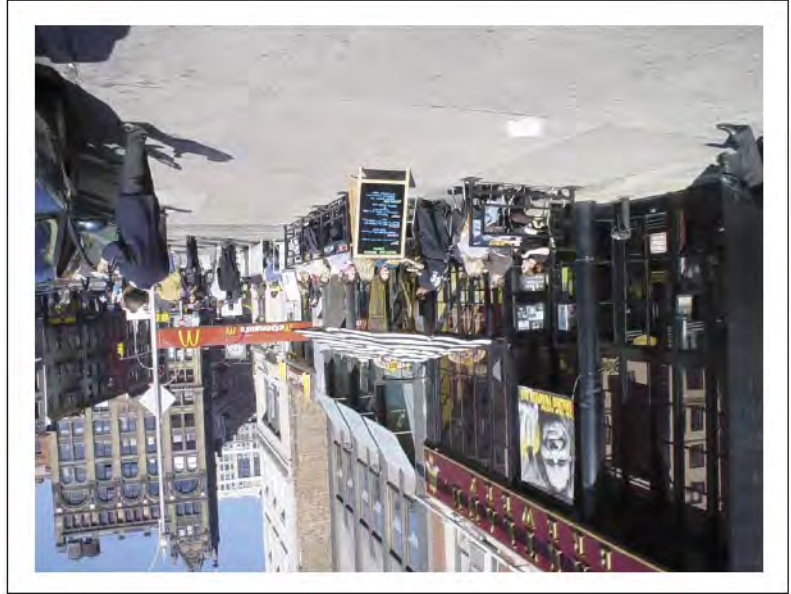

004. 005. 006. 007.



North Point

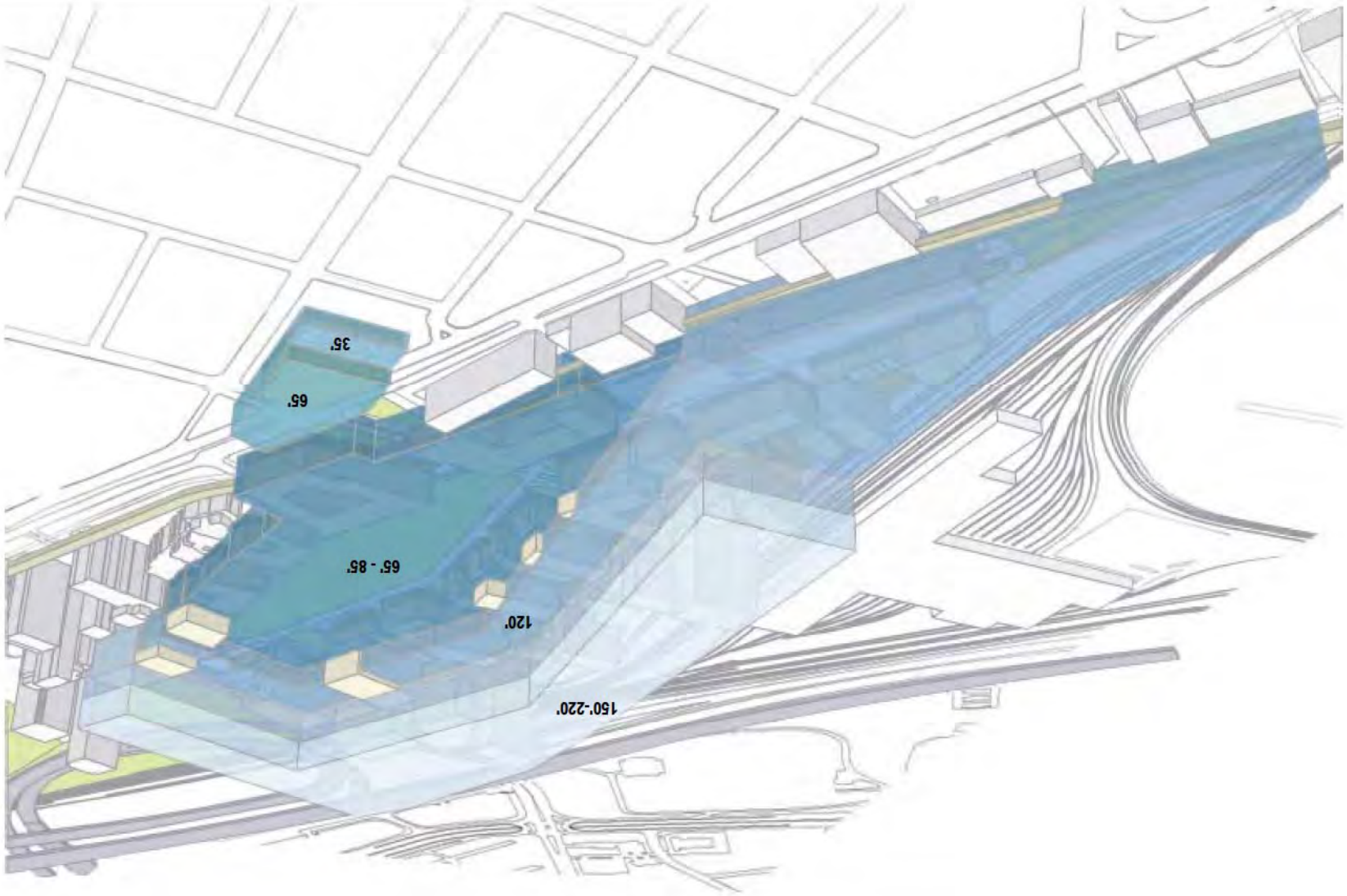

North Point

First Street Extension Cross Section

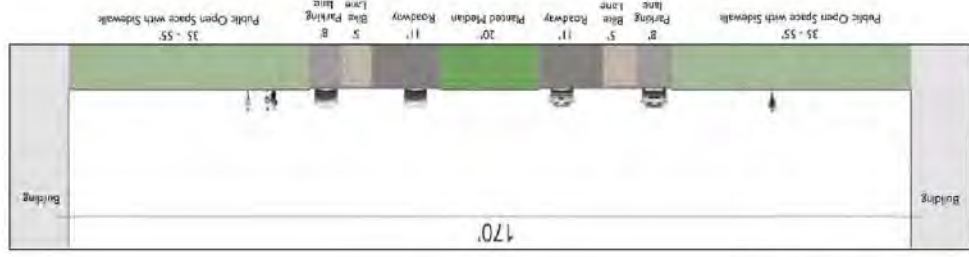

Street Hierarchy



Block Interceptor/Service Street Section



Park Perimeter Street Cross Section

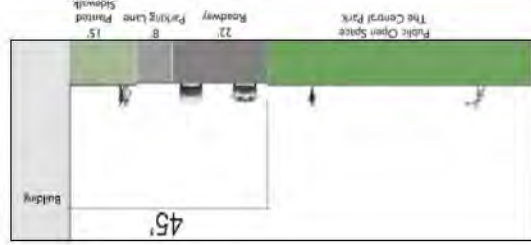

Green Fingers Cross Section

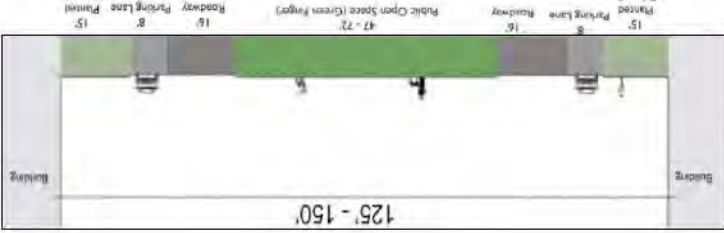

West Boulevard Cross Section

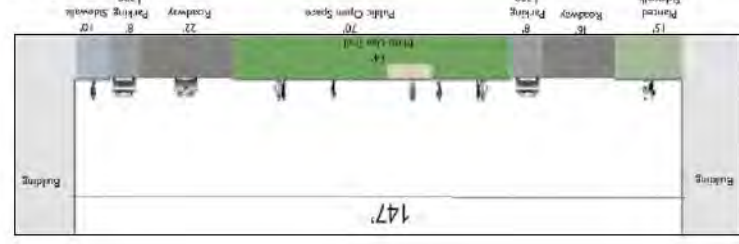

North Point

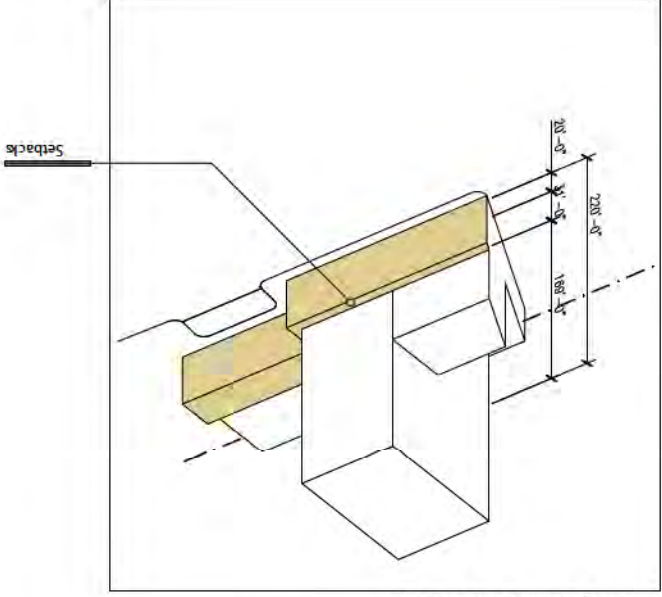

Building Massing and Setbacks



003
004
002
001



005
006
007
008



North Point

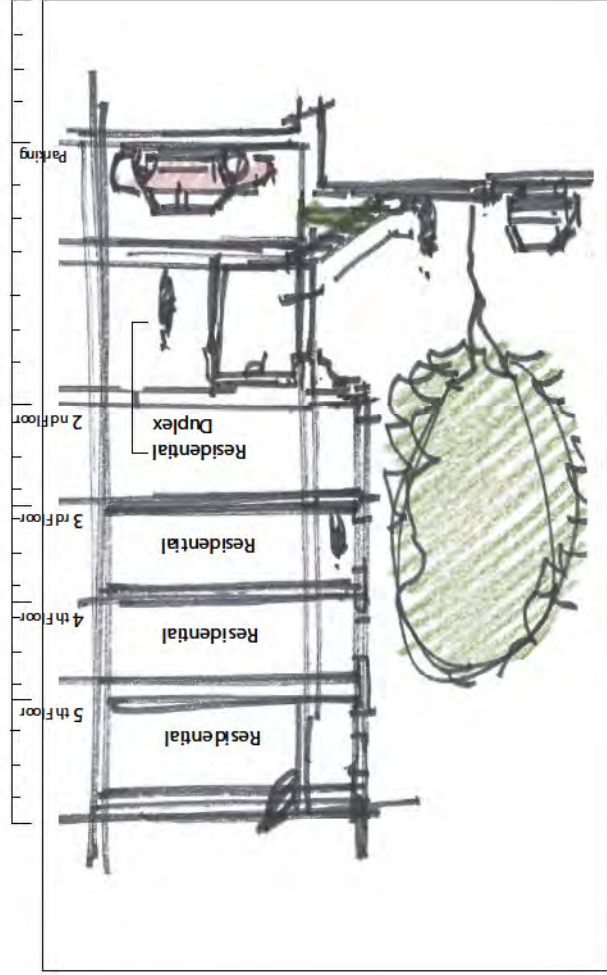
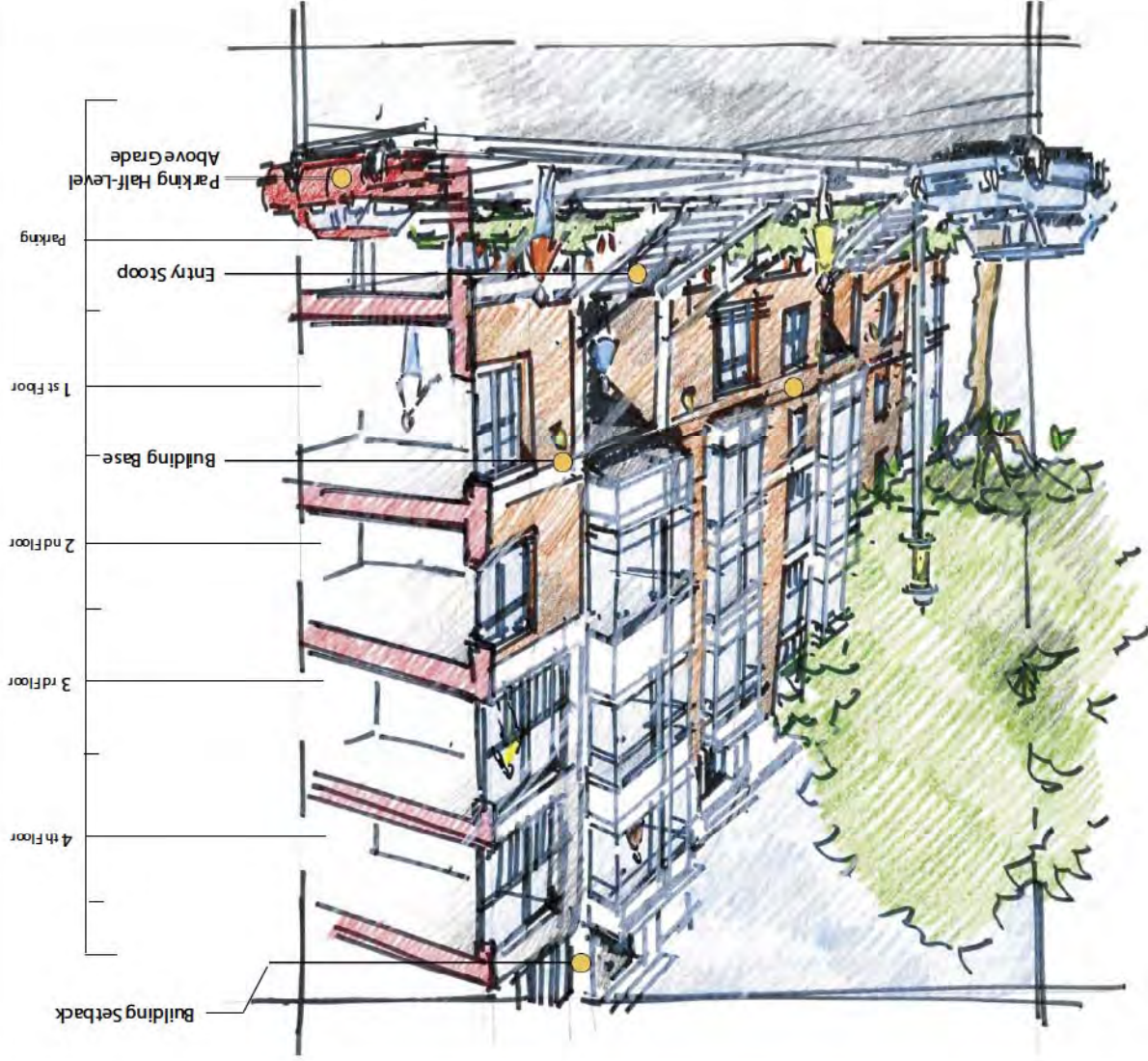

North Point

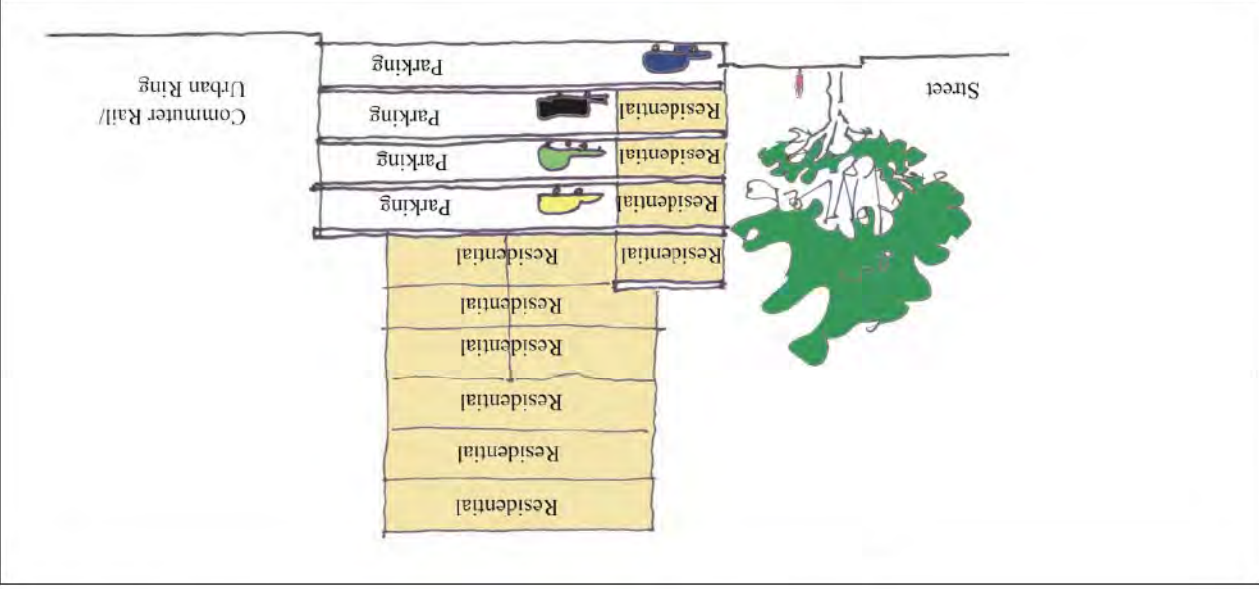

001.



002.



North Point

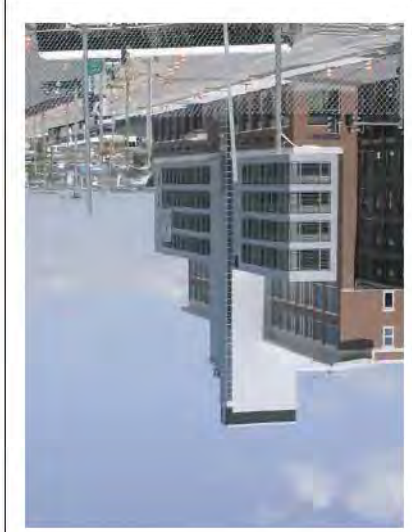
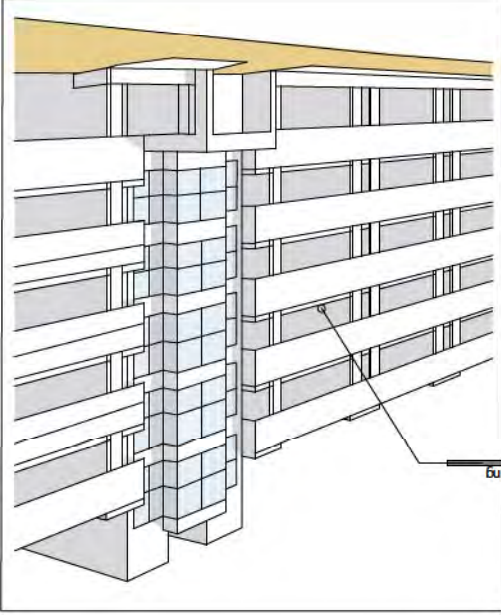

Parking



003.

002.

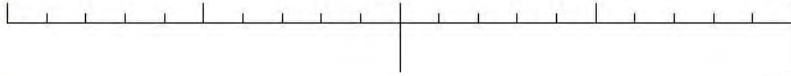

001.



007.

006.

005.

004.

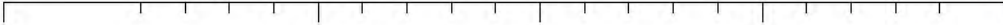

North Point

LANDSCAPE CHARACTER IMAGES
EXHIBIT 16

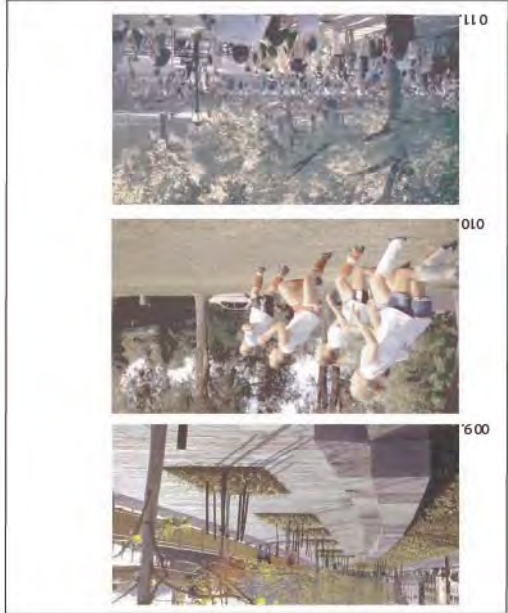
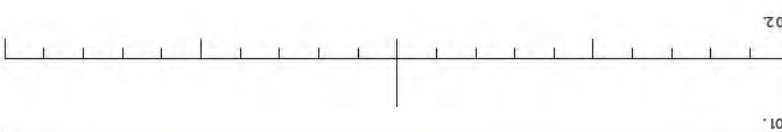

North Point

COMMUNITY, CULTURAL, AND OPEN SPACE OPPORTUNITIES
EXHIBIT 17

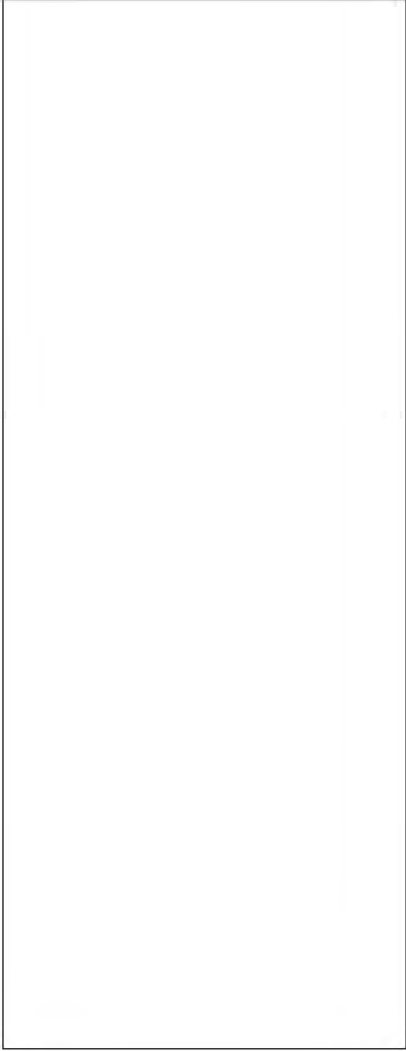

North Point

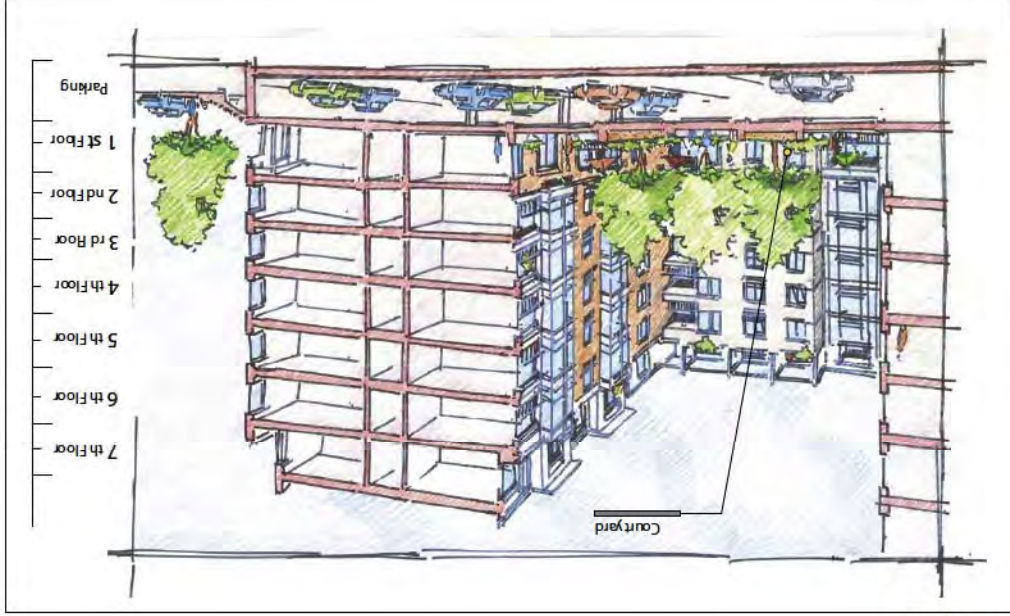

Courtyards

004. 005. 006. 007.



002. 003.

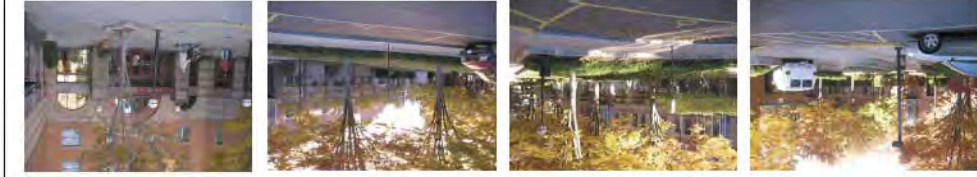

North Point

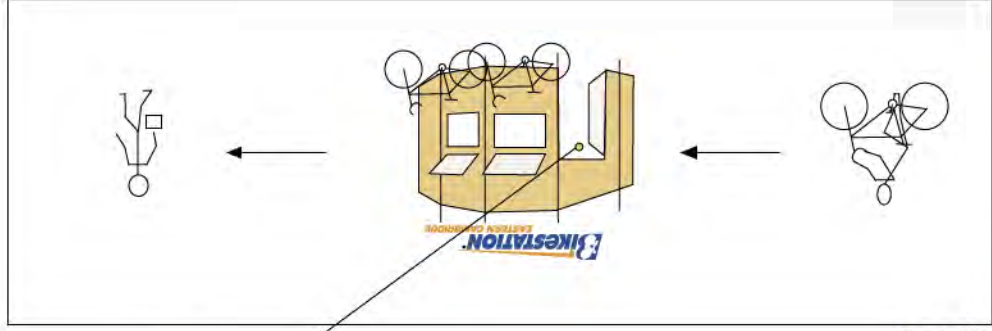

Bike Station

Bike Station



003.

002.

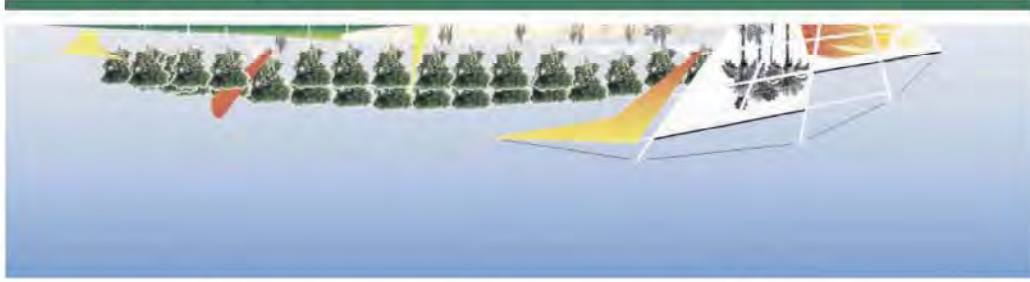

007.

006.

005.

004.



001.

Eastern Cambridge Design Guidelines: North Point

Building A Guidelines

Approximate Dimensions

Parcel Size: 44,500 SF.
 Gross Square Footage: (+/-) 192,000 SF.
 Uses: Residential
 No. of Dwelling Units: (+/-) 165
 Parking Levels: Below grade, Up to three above grade
 Maximum Height of the Building: 120'
 Lot Coverage: 100%
 Primary Pedestrian Access: West Boulevard
 Vehicular Access: West Boulevard

Design Guidelines

The envelope is a 4 - 8 story perimeter building base and middle with a tower of up to approximately 11 stories. A line of expression at the second floor level defines the base and is intended to humanize the scale of the buildings and create an intimate pedestrian experience. This should be achieved by means of material articulation or architectural detailing. Each Base, in its entirety, will be designed to give the appearance of greater height than any single floor in the Middle. The tower portion of the building shall be set back from West Boulevard facade and located along the eastern portion of the building. This will allow for spectacular views to the surrounding areas and the central park from the upper levels. The frontage of the building on the boulevard is encouraged to take advantage of the south exposure by means of balconies, terraces and bow windows. A variety of residential types such as loft style units and apartments are encouraged. Along with the above grade parking to the north of the parcel, the proposed configuration helps mitigate the noise and vibration from the MBTA tracks by reducing the exposure of residential surfaces to the north. Parking structures may be faced with other allowable uses, such as residential or commercial to limit exposure to the West Boulevard.

Building design shall give special attention to the approximately 8 - story building on western corner and its architectural treatment shall acknowledge the gateway to the site from the west. Building design shall also give special consideration to the streetscape and scale of the West Boulevard by successfully integrating the variety of residential types. Building design shall make a special effort to minimize the orientation towards the MBTA railroad yards to the north.

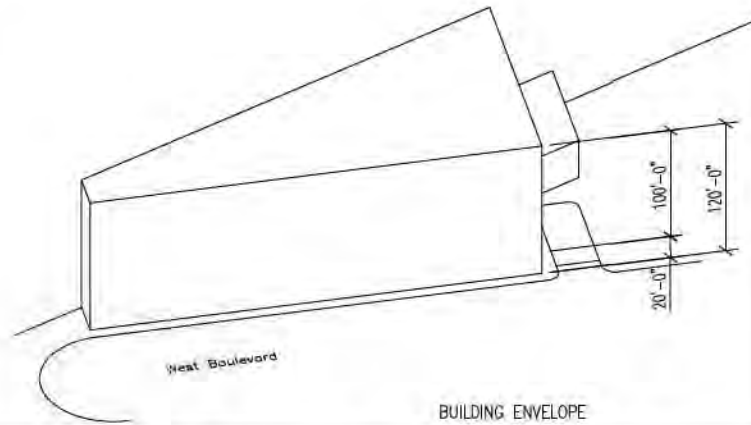
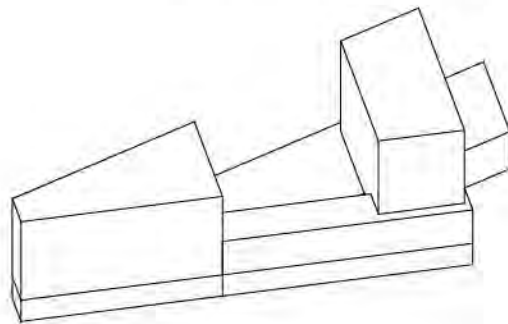
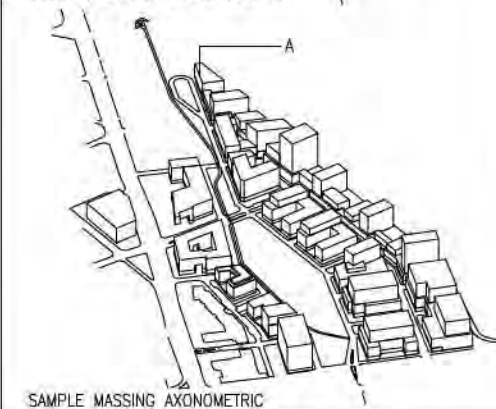
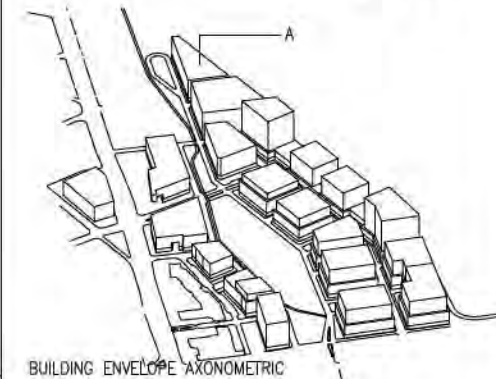
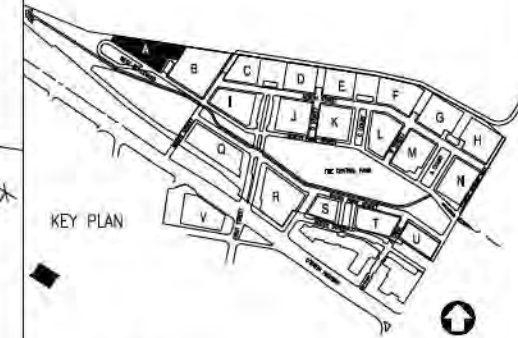
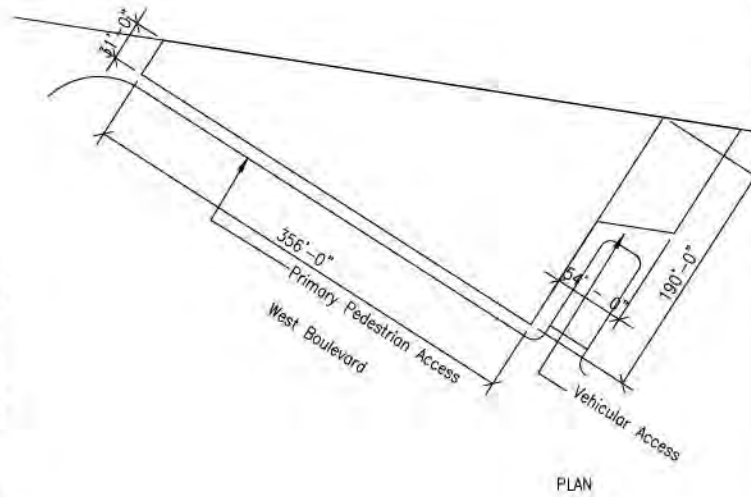

North Point

Building B Guidelines

Approximate Dimensions

Parcel Size: 74,000 SF.
 Gross Square Footage: (+/-) 334,000 SF.
 Uses: Residential
 No. of Dwelling Units: (+/-) 290
 Parking Levels: Below grade, Up to three above grade
 Maximum Height of the Building: 150'
 Lot Coverage: 100%
 Primary Pedestrian Access: West Boulevard, Water Street
 Vehicular Access: Water Street

Design Guidelines

The envelope is a 4 – 7 story perimeter building base and middle with a tower of up to approximately 11 stories. A line of expression at the second floor level defines the base and is intended to humanize the scale of the buildings and create an intimate pedestrian experience. This should be achieved by means of material articulation or architectural detailing. Each Base, in its entirety, will be designed to give the appearance of greater height than any single floor in the Middle. The tower portion of the building shall be set back from West Boulevard facade and located along the eastern portion of the building. This will allow spectacular views to the surrounding areas and the central park from the upper levels. This orientation is intended to minimize shadows on public areas and surrounding buildings. The frontage of the building on the boulevard is encouraged to take advantage of the south exposure by means of balconies, terraces and bow windows. Along with the above grade parking, the proposed configuration helps mitigate the noise and vibration from the MBTA tracks by reducing the exposure of residential surfaces to the north. Parking structures may be faced with other allowable uses, such as residential or commercial to limit exposure to West Boulevard and Water Street.

Building design shall also make special consideration to the streetscape and scale of the West Boulevard by successfully integrating a variety of housing types including loft style units to residential flats. Building designs shall make a special attempt in creating and maintaining the character and scale of the internal courtyard.

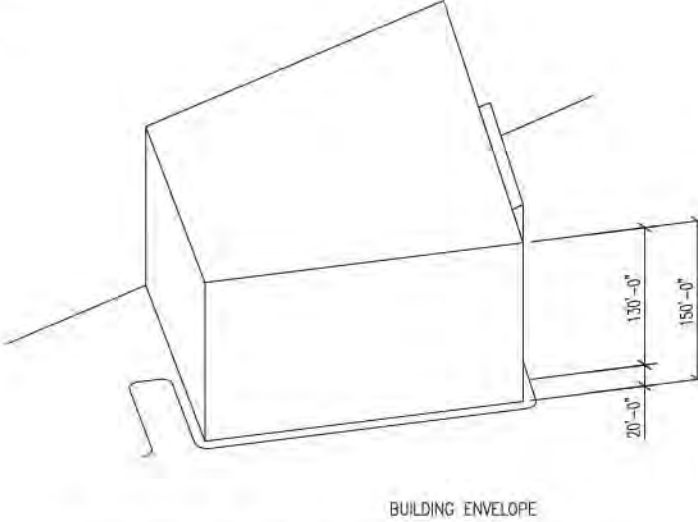
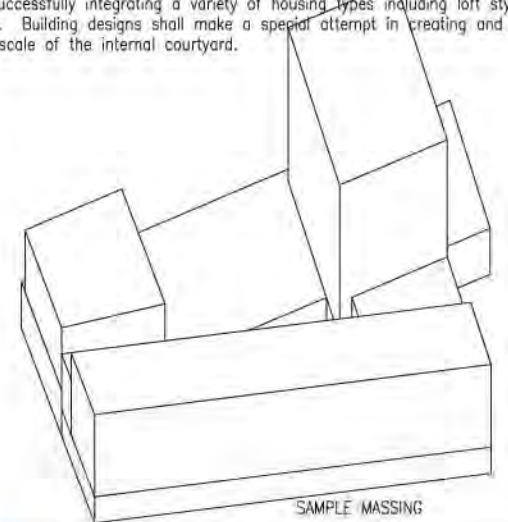
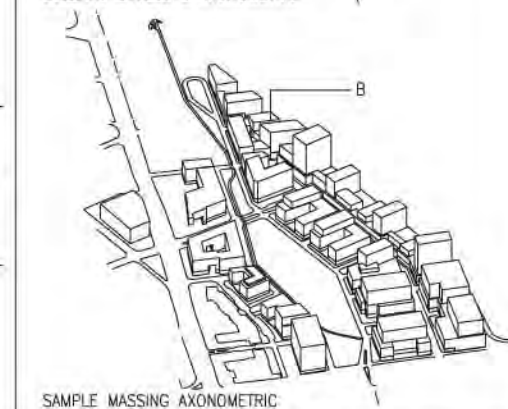
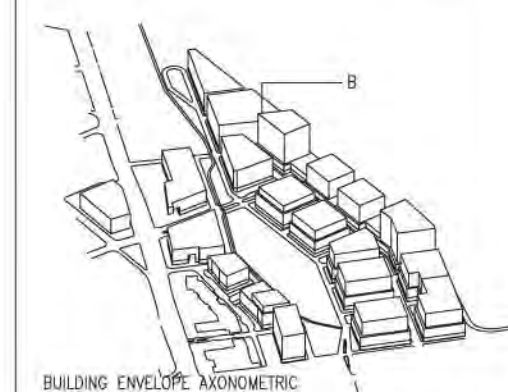
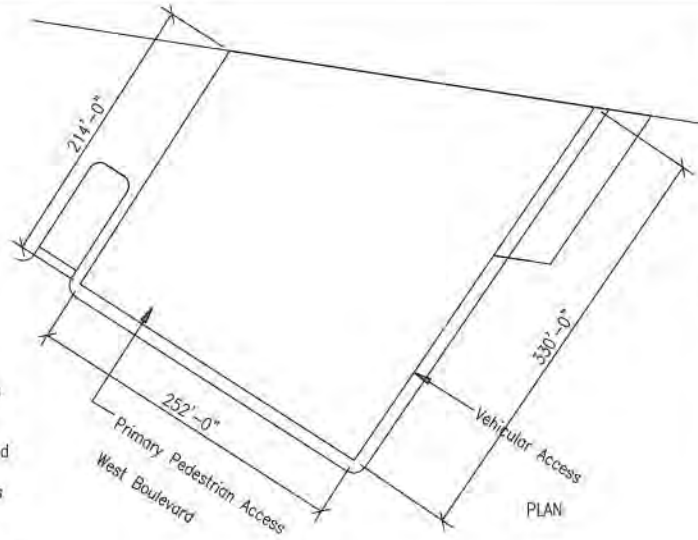

Building C Guidelines

Approximate Dimensions

Parcel Size: 50,000 SF.
 Gross Square Footage: (+/-) 357,000 SF.
 Uses: Residential
 No. of Dwelling Units: (+/-) 310
 Parking Levels: Below grade, Up to three above grade
 Maximum Height of the Building: 220'
 Lot Coverage: 100%
 Primary Pedestrian Access: North Street
 Vehicular Access: Water Street

Design Guidelines

The envelope is a 4 – 6 story perimeter building comprising of Base and Middle with a tower of up to approximately 21 stories which is the Top. A line of expression at the third floor level defines the base and is intended to humanize the scale of the buildings and create an intimate pedestrian experience. This should be achieved by means of material articulation or architectural detailing. Each Base, in its entirety, will be designed to give the appearance of greater height than any single floor in the Middle. The lower portions of the building shall be along the eastern side of the parcel. These portions shall be set back from the North Street facade by at least 10ft. The proposed orientation and location of the tower will allow spectacular views of the surrounding areas and the central park from the upper levels. The configuration shall positively use the orientation and exposure to sun and minimize shadows on public areas and surrounding buildings. Along with the above grade parking, the proposed configuration helps mitigate the noise and vibration from the MBTA tracks by reducing the exposure of residential surfaces to the north. Parking structures may be faced with other allowable uses, such as residential or commercial to limit exposure to North Street.

Building design shall make a special attempt to relate to the streetscape and the scale of the North Street. It shall successfully integrate the above grade parking with the low and mid rise residential buildings. Design should make a special attempt to celebrate the termination of First Street as well as the spirit of green fingers.

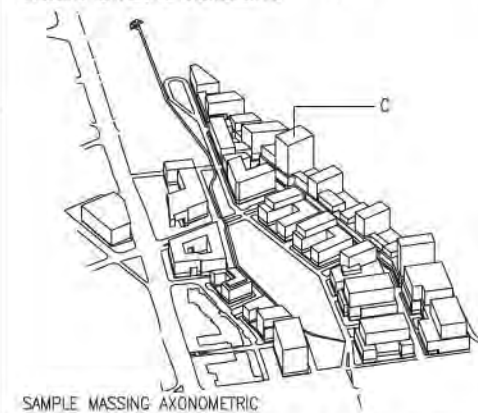
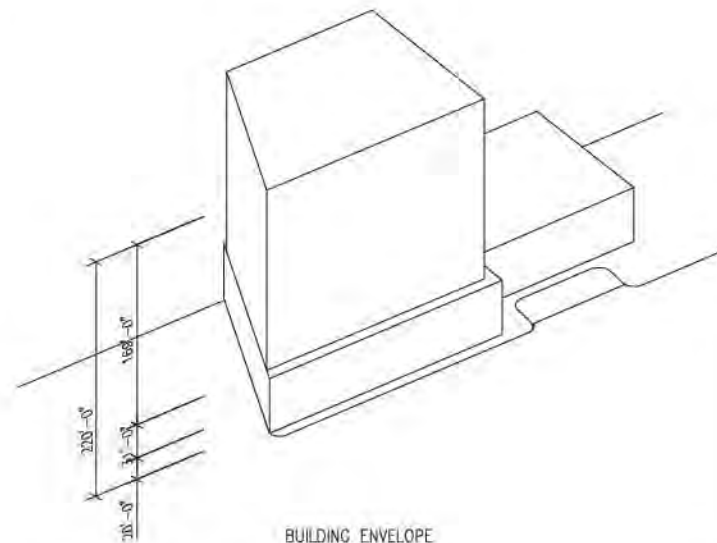
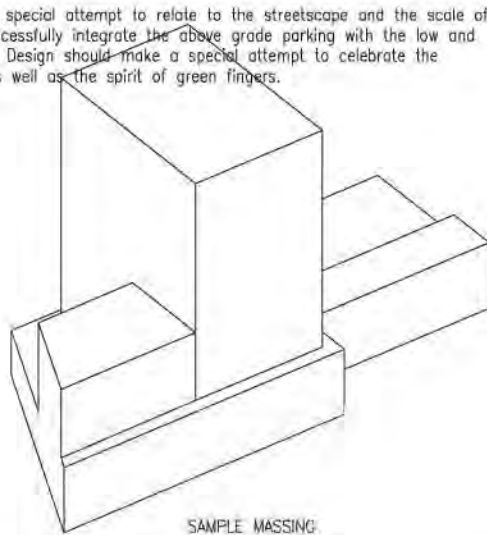
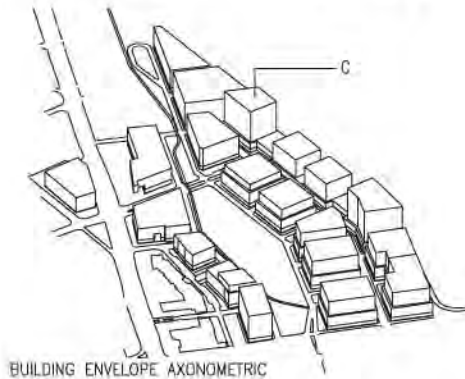
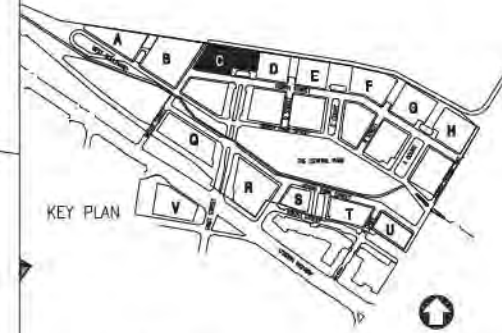
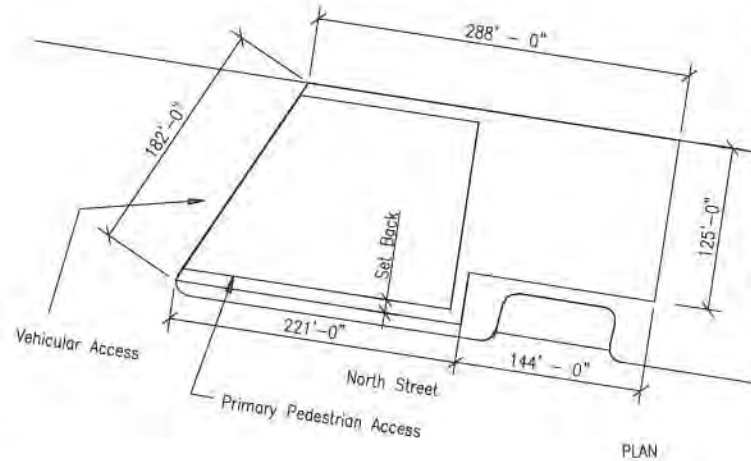

North Point

Greenberg Consultants Ltd.

cbt . . .

childs.barmen.teeckarsinc

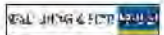

Building D Guidelines

Approximate Dimensions
 Parcel Size: 40,000 SF.
 Gross Square Footage: (+/-) 177,000 SF.
 Uses: Residential
 No. of Dwelling Units: (+/-) 150
 Parking Levels: Below grade, Up to three above grade
 Maximum Height of the Building: 150'
 Lot Coverage: 100%
 Primary Pedestrian Access: North Street
 Vehicular Access: North Street

Design Guidelines
 The envelope is a 4 - 6 story perimeter building base and middle with a tower of up to approximately 14 stories. A line of expression at the second floor level defines the base and is intended to humanize the scale of the buildings and create an intimate pedestrian experience. This should be achieved by means of material articulation or architectural detailing. Each Base, in its entirety, will be designed to give the appearance of greater height than any single floor in the Middle. The taller portions of the building shall be along the eastern side of the parcel. The taller portions shall be set back by at least 10' from the face of the base and middle. This orientation will allow spectacular views of the surrounding areas and the central park from the upper levels. The configuration shall positively use the orientation and exposure to sun. Along with the above grade parking, the proposed configuration helps mitigate the noise and vibration from the MBTA tracks by reducing the exposure of residential surfaces to the north. Parking structures may be faced with other allowable uses, such as residential or commercial, to limit exposure to North Street.

Building design shall make a special attempt to relate to the streetscape and the scale of the North Street. It shall successfully integrate the above grade parking with the low and mid rise residential buildings. Design should make a special attempt to celebrate the termination of the First Street as well as the spirit of the green fingers.

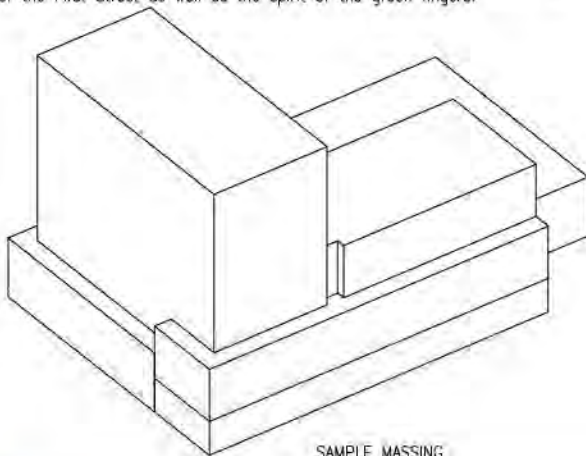

SAMPLE MASSING

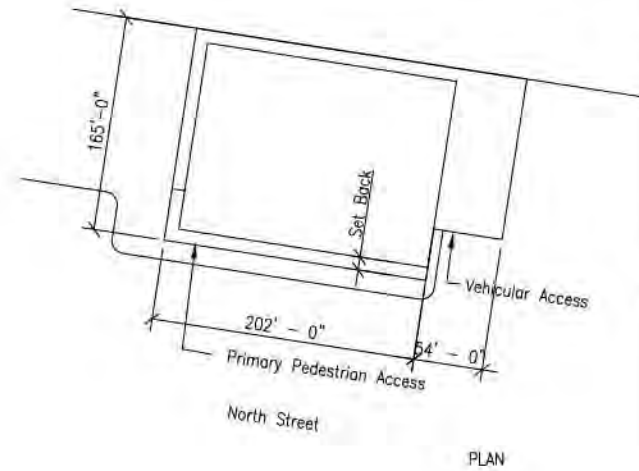

PLAN

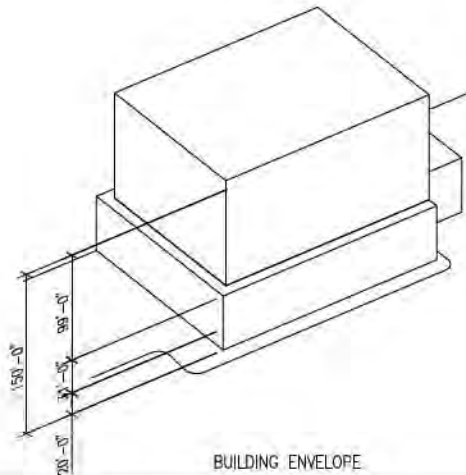

BUILDING ENVELOPE

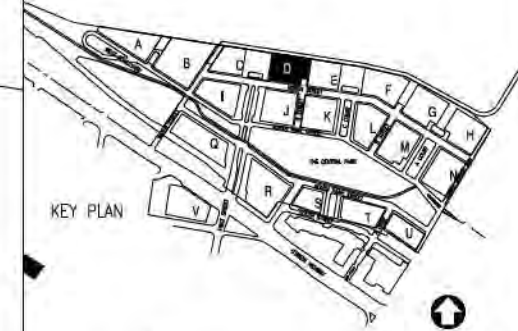

KEY PLAN

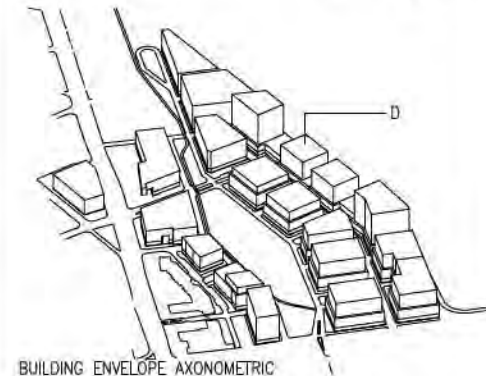

BUILDING ENVELOPE AXONOMETRIC

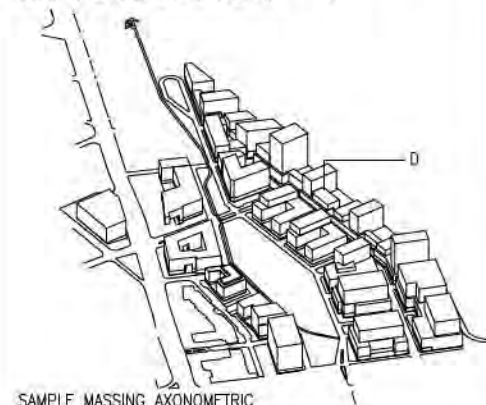

SAMPLE MASSING AXONOMETRIC

North Point

Building E Guidelines

Approximate Dimensions
 Parcel Size: 55,000 SF.
 Gross Square Footage: (+/-) 157,000 SF.
 Uses: Residential
 No. of Dwelling Units: (+/-) 135
 Parking Levels: Below grade, Up to three above grade
 Maximum Height of the Building: 150'
 Lot Coverage: 100%
 Primary Pedestrian Access: North Street
 Vehicular Access: North Street

Design Guidelines

The envelope is a 4 – 6 story perimeter building base and middle with a tower of up to approximately 12 stories. A line of expression at the second floor level defines the base and is intended to humanize the scale of the buildings and create an intimate pedestrian experience. This should be achieved by means of material articulation or architectural detailing. Each Base, in its entirety, will be designed to give the appearance of greater height than any single floor in the Middle. The tower portions of the building shall be along the eastern side of the parcel. The taller portions shall be set back by at least 10' from the face of the base and middle. This orientation will allow spectacular views to the surrounding areas and the central park from the upper levels. The configuration shall positively use the orientation and exposure to sun. Along with the above grade parking, the proposed configuration helps mitigate the noise and vibration from the MBTA tracks by reducing the exposure of residential surfaces to the north. Parking structures may be faced with other allowable uses, such as residential or commercial to limit exposure to North Street

Building design shall make a special attempt to relate to the streetscape and the scale of the North Street. Design should make an attempt to frame and contribute to the scale and character of green finger.

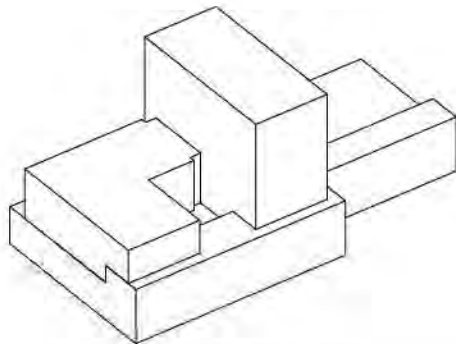

SAMPLE ENVELOPE

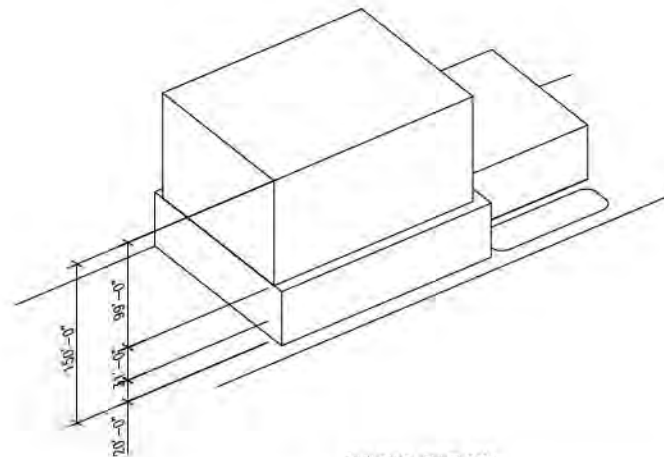

BUILDING ENVELOPE

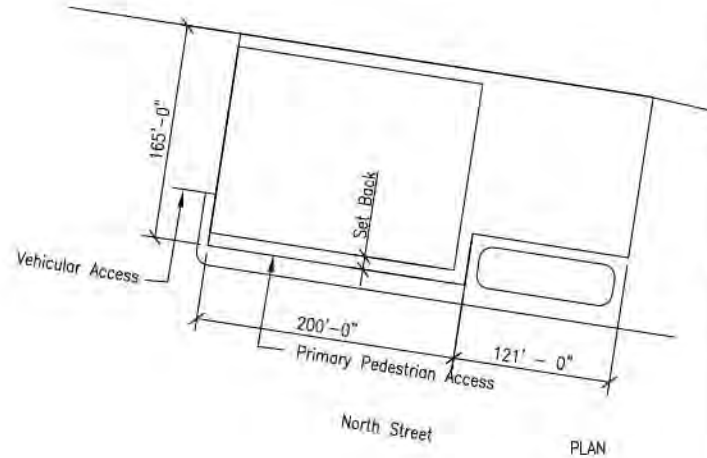

PLAN

KEY PLAN AND AXONOMETRIC

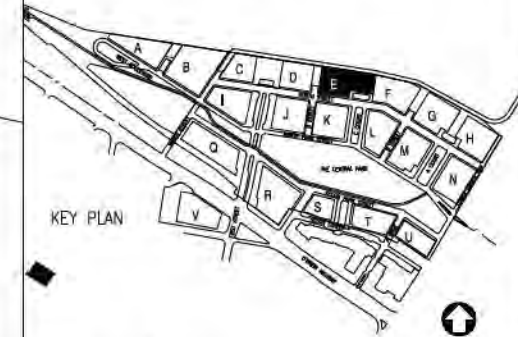

KEY PLAN

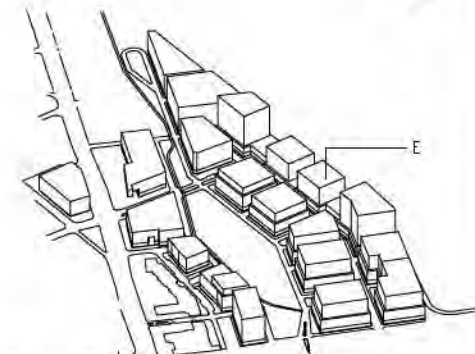

BUILDING ENVELOPE AXONOMETRIC

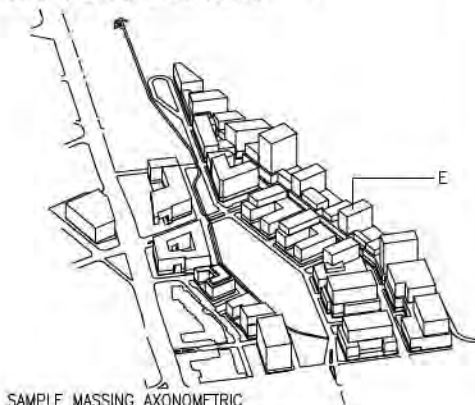

SAMPLE MASSING AXONOMETRIC

Building F Guidelines

Approximate Dimensions

Parcel Size: 44,500 SF.
 Gross Square Footage: (+/-) 342,000 SF.
 Uses: Residential
 No. of Dwelling Units: (+/-) 295
 Parking Levels: Below grade, Up to three above grade
 Maximum Height of the Building: 220'
 Lot Coverage: 100%
 Primary Pedestrian Access: North Street
 Vehicular Access: North Street

Design Guidelines

The envelope is a 4 - 6 story perimeter building base and middle with a tower of up to approximately 21 stories. A line of expression at the third floor level defines the base and is intended to humanize the scale of the buildings and create an intimate pedestrian experience. This should be achieved by means of material articulation or architectural detailing. Each Base, in its entirety, will be designed to give the appearance of greater height than any single floor in the Middle. The tower portions of the building shall be along the eastern side of the parcel and should be set back by at least 10 ft. from the North Street facade. This will allow spectacular views to the surrounding areas and the central park from upper levels. The configuration shall positively use the orientation and exposure to sun. Along with the above grade parking, the proposed configuration helps mitigate the noise and vibration from the MBTA tracks by reducing the exposure of residential surfaces to the north. Parking structures may be faced with other allowable uses, such as residential or commercial to limit exposure to North Street.

Building design shall make a special attempt to relate to the streetscape and the scale of the North Street. Design should make an attempt to frame and contribute to the scale and character of C - Court.

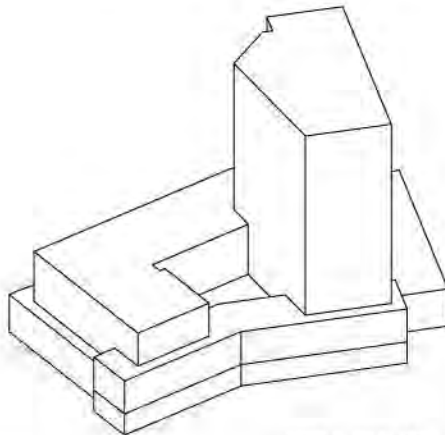
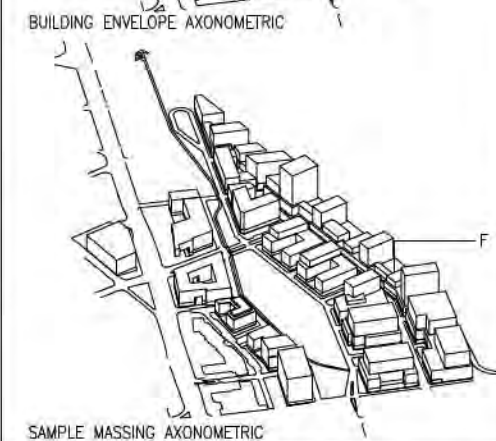
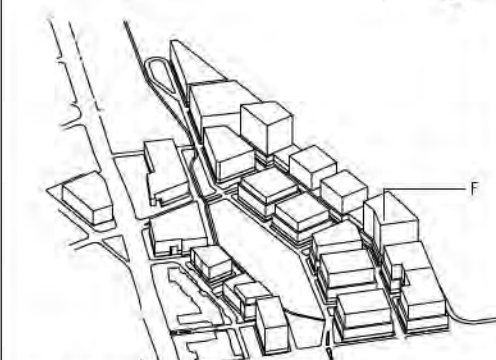
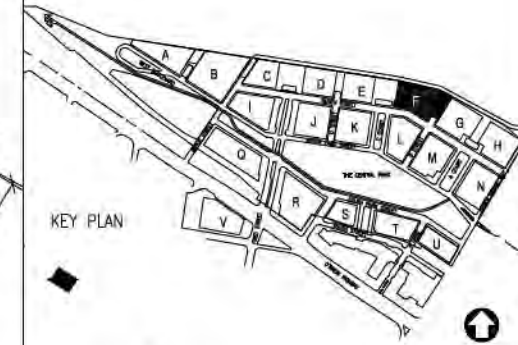
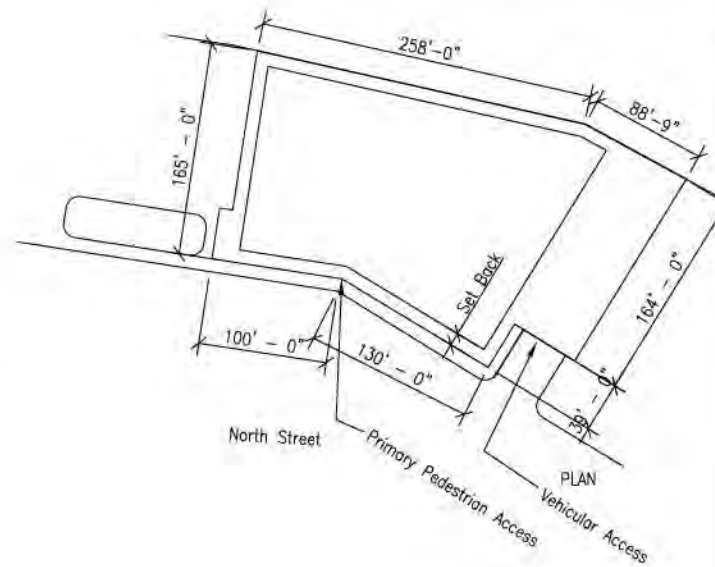

SAMPLE ENVELOPE

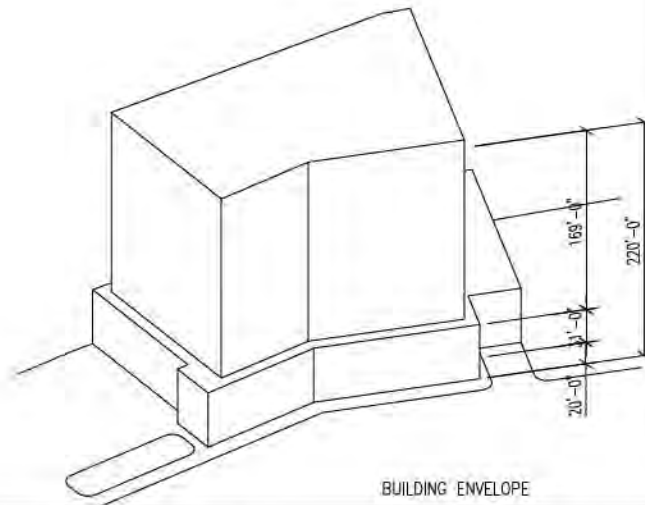

BUILDING ENVELOPE

North Point

Building G Guidelines

Approximate Dimensions
 Parcel Size: 44,000 SF.
 Gross Square Footage: (+/-) 370,000 SF.
 Uses: Commercial
 Parking Levels: Below grade, up to three above grade
 Maximum Height of the Building: 150'
 Lot Coverage: 100%
 Primary Pedestrian Access: North Street
 Vehicular Access: North Street

Design Guidelines
 The ground level would address the primary streets and the court with a high level of transparency and high ceilings. The envelope will be an approximately 5 - story perimeter building base and middle with a tower of up to approximately 11 stories. A line of expression at the third floor level defines the base and is intended to humanize the scale of the buildings and create an intimate pedestrian experience. This should be achieved by means of material articulation or architectural detailing. Each Base, in its entirety, will be designed to give the appearance of greater height than any single floor in the Middle. Any building mass above the base and the middle shall be set back by at least 10 ft from the facade. The tower portions of the building should be concentrated towards the north of the parcel. This orientation will take advantage of the south exposure and views to the central park and allow for courtyard terraces facing south. Along with the above grade parking to the north of the parcel, the proposed configuration helps mitigate the noise and vibration from the MBTA tracks by reducing the exposure of residential surfaces to the north. Parking structures may be faced with other allowable uses, such as residential or commercial to limit exposure to North Street

Building design shall make special consideration to the streetscape of the North Street to conform to the overall legibility of the street. The building may share an atrium or common entry lobby with the building in Parcel H. Building design should contribute to the creation, character and scale of the green finger to encourage informal interaction.

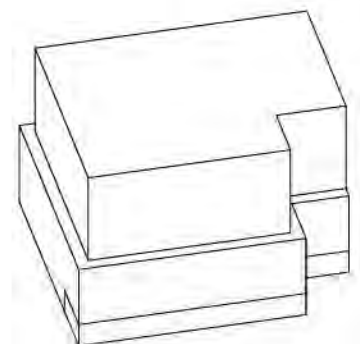
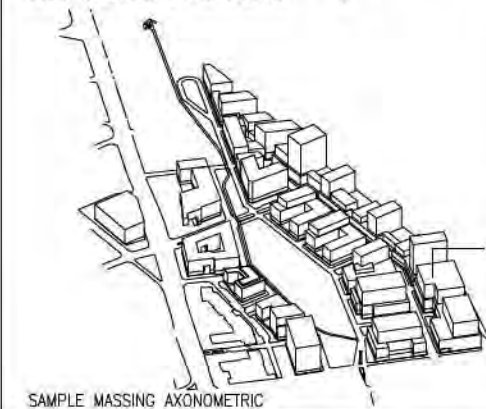
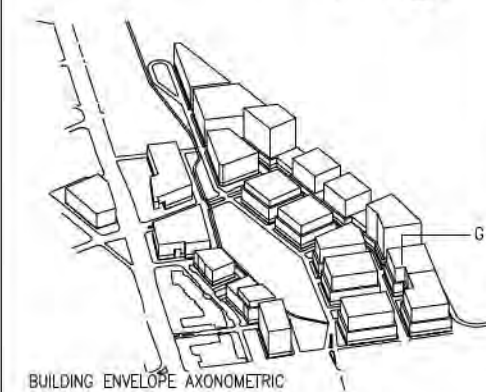
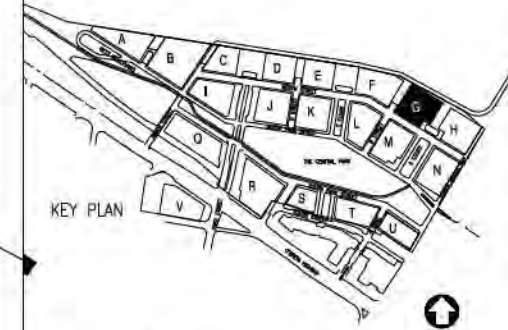
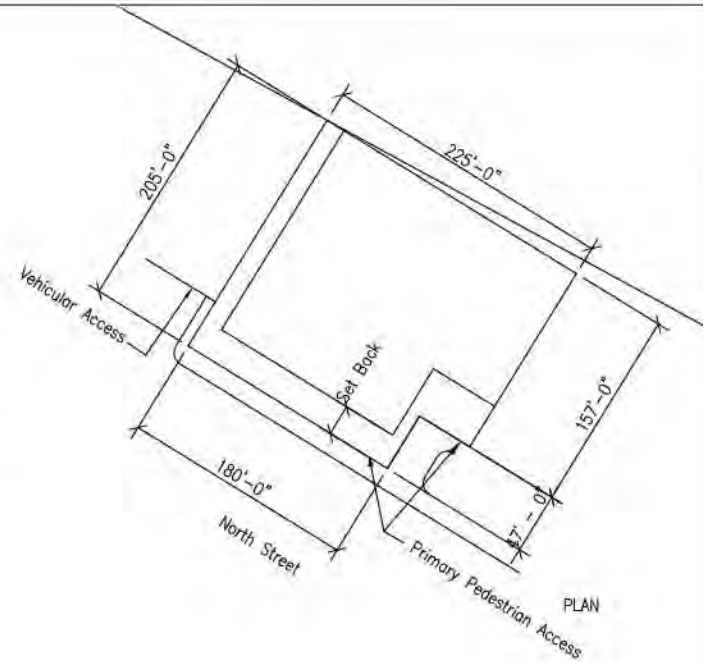

BUILDING ENVELOPE

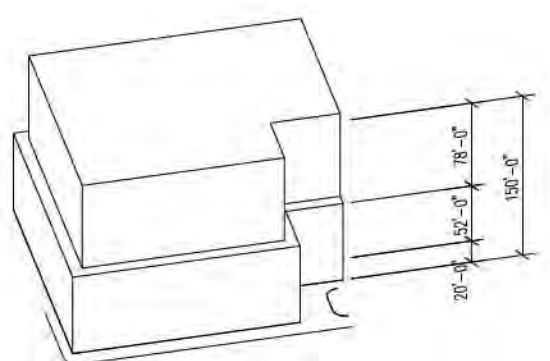

BUILDING ENVELOPE

North Point

Building H Guidelines

Approximate Dimensions

Parcel Size: 53,000 SF.

Gross Square Footage: (+/-) 258,000 SF.

Uses: Commercial

Parking Levels: Below grade, Up to three above grade

Maximum Height of the Building: 150'

Lot Coverage: 100%

Primary Pedestrian Access: North Street

Vehicular Access: Lower Bridge Street

Design Guidelines

The ground level would address the primary streets and the court with a high level of transparency and high ceilings. Entrances from the Gilmore Bridge at a higher level create an opportunity for enhanced public realm and a dynamic office environment. The envelope will be a 5-story perimeter building base and middle with an upper envelope of up to approximately 10 stories. A line of expression at the third floor level defines the base and is intended to humanize the scale of the buildings and create an intimate pedestrian experience. This should be achieved by means of material articulation or architectural detailing. Each Base, in its entirety, will be designed to give the appearance of greater height than any single floor in the Middle. Any building mass above the base and the middle shall be set back by at least 10 ft. from the facade. The upper portions should be concentrated towards the north of the parcel. This orientation will take advantage of the south exposure and views to the central park and allow for courtyard terraces facing south. Along with the above grade parking, the proposed configuration helps mitigate the noise and vibration from the MBTA tracks by reducing the exposure of residential surfaces to the north. Parking structures may be faced with other allowable uses, such as residential or commercial to limit exposure to North Street.

Building design should give a special consideration to create connections from Gilmore Bridge to the site through the building. The sidewalk on the Gilmore Bridge may be extended up to the building. Direct entrances may be created to the building at that level to enhance the quality of pedestrian movement to the Orange Line T stop and Charlestown. The building may share an atrium or common entry space with the building in Parcel G. The design should also contribute to the creation, character and scale of the green finger to encourage informal interaction.

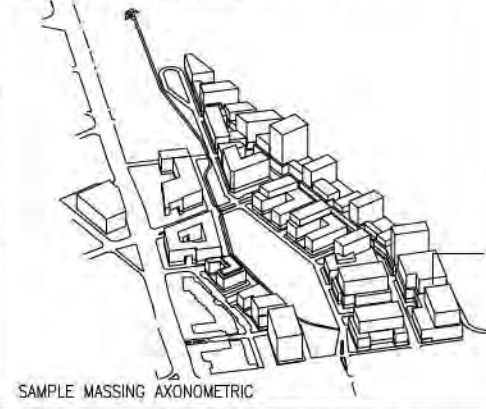
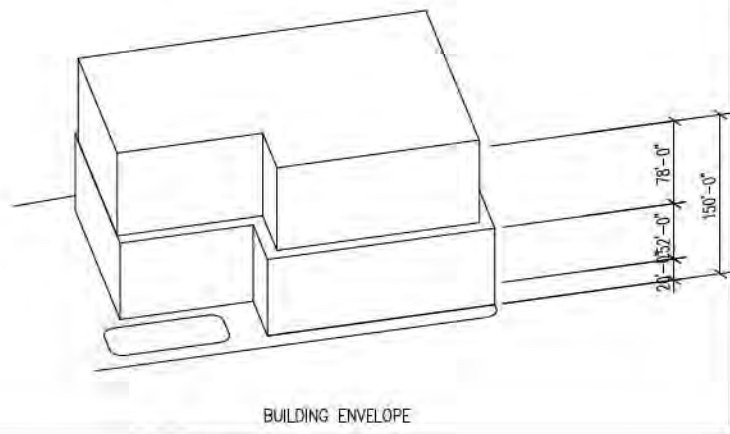
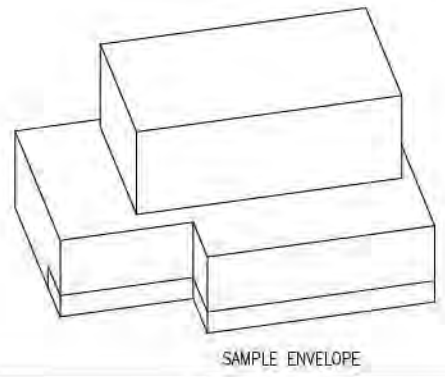
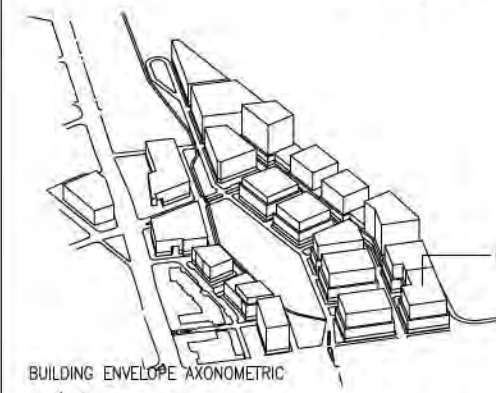
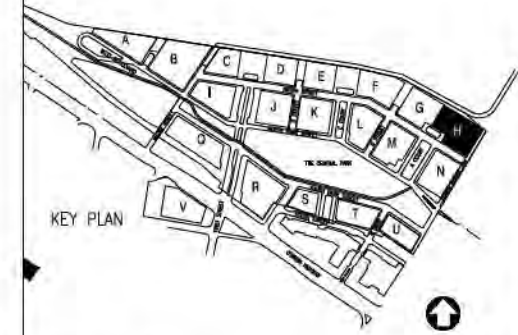
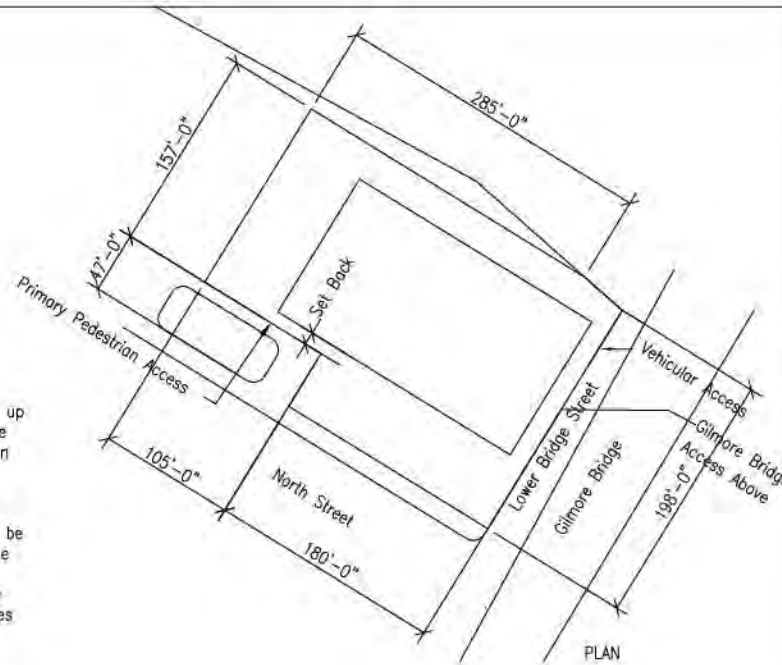

Building I Guidelines

Approximate Dimensions

Parcel Size: 40,000 SF.
 Gross Square Footage: (+/-) 280,000 SF.
 Uses: Residential
 No. of Dwelling Units: (+/-) 240
 Parking Levels: Below grade, one half level above grade
 Maximum Height of the Building: 120'
 Lot Coverage: 100%
 Primary Pedestrian Access: West Boulevard, First Street
 Vehicular Access: Water Street

Design Guidelines

The building envelope is designed to take advantage of its orientation and exposure to sun. The envelope is a 7-11 story perimeter building with a line of expression at the second floor level. The line of expression defines the base and is intended to humanize the scale of the buildings and create an intimate pedestrian experience. This should be achieved by means of material articulation or architectural detailing. Each Base, in its entirety, will be designed to give the appearance of greater height than any single floor in the Middle. Courtyards of any form may be carved out of this mass in the middle of the parcel. The taller portions of the building shall be located along the eastern side of the parcel facing the green on First Street and allowing views to the central park from the upper levels.

Building design shall make special consideration to the streetscape on the North Park Street and First Street to conform to the overall legibility. Projections like bow windows, balconies and terraces are encouraged on all sides, specifically on the south to take advantage of both sun and spectacular views of the park. Building designs shall make a special attempt in creating and maintaining the character and scale of the courtyard.

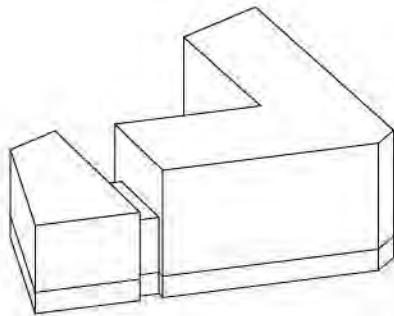
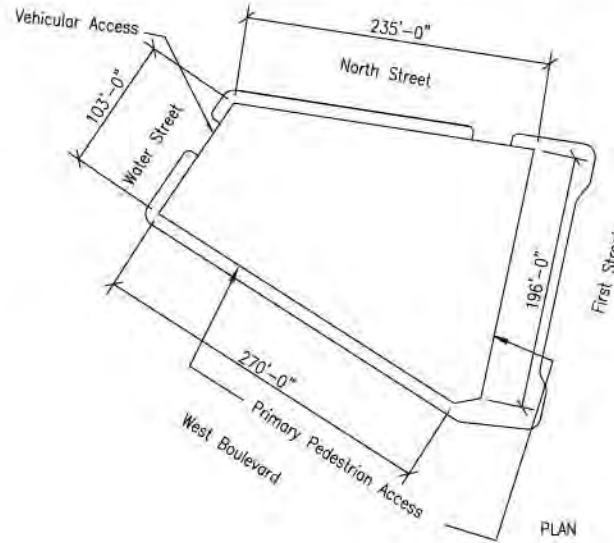

SAMPLE MASSING

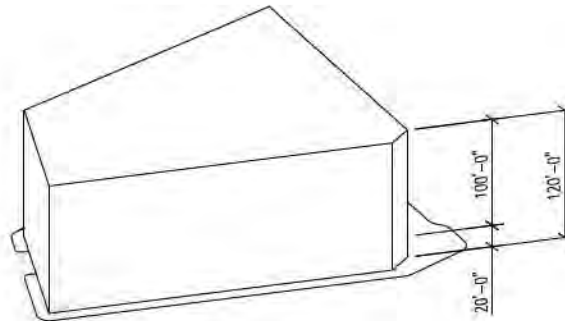

BUILDING ENVELOPE

KEY PLAN AND AXONOMETRIC

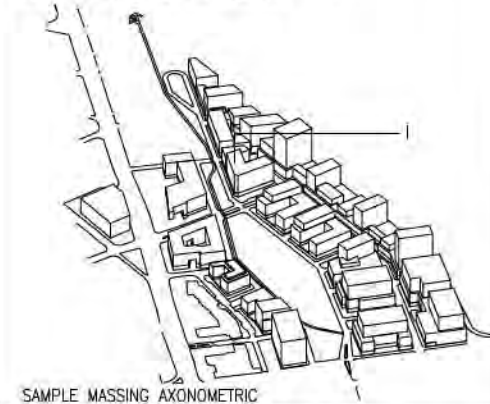
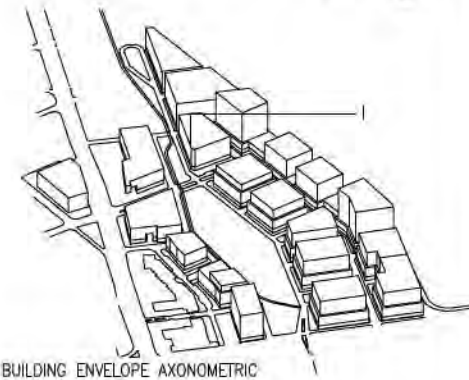
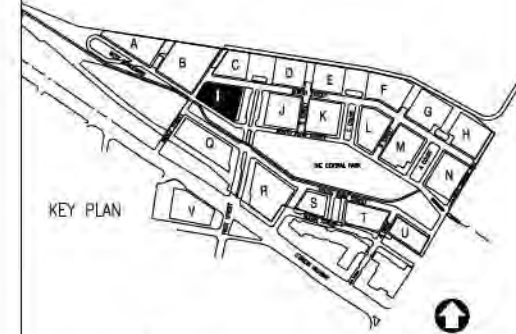

Building J Guidelines

Approximate Dimensions

- Parcel Size: 41,000 SF.
- Gross Square Footage: (+/-) 265,000 SF.
- Uses: Residential
- No. of Dwelling Units: (+/-) 230
- Parking: Below grade, one half level above grade
- Maximum Height of the Building: 120'
- Lot Coverage: 76%
- Primary Pedestrian Access: North Park Street, First Street and North Street
- Vehicular Access: D - Street

Design Guidelines

The building envelope is designed to take advantage of its orientation and exposure to sun. The envelope is a 6 -7 story perimeter building base and middle with a tower of up to approximately 11 stories. A line of expression at the second floor level defines the base and is intended to humanize the scale of the buildings and create an intimate pedestrian experience. This should be achieved by means of material articulation or architectural detailing. Each Base, in its entirety, will be designed to give the appearance of greater height than any single floor in the Middle. Courtyards of any form may be carved out of this mass in the middle of the parcel. The courtyard shall open towards the south to allow for exposure to sun. Any building mass above 6 -7 stories shall be set back at least 10 ft from the face of the base mass. The tower portions of the building shall be located along the western side of the parcel. This orientation will allow spectacular views to the surrounding areas and the central park from the upper levels.

Building design shall make special consideration to the streetscape on the North Park Street and First Street to conform to the overall legibility. Projections like bow windows, balconies and terraces are encouraged on all sides, specifically on the south to take advantage of both sun and spectacular views of the park. Building designs shall make a special attempt in creating and maintaining the character and scale of the courtyard.

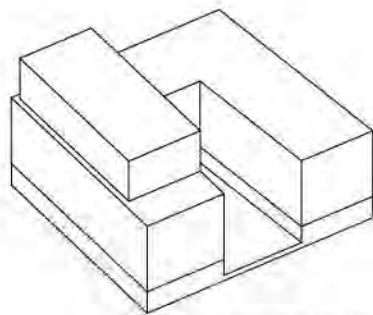
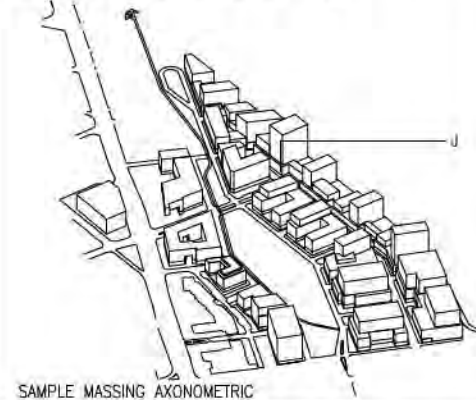
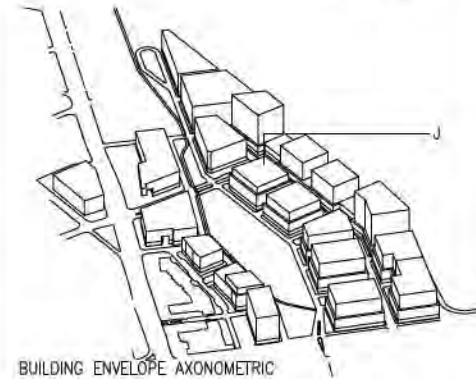
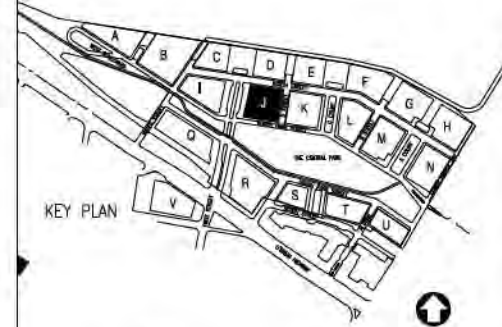
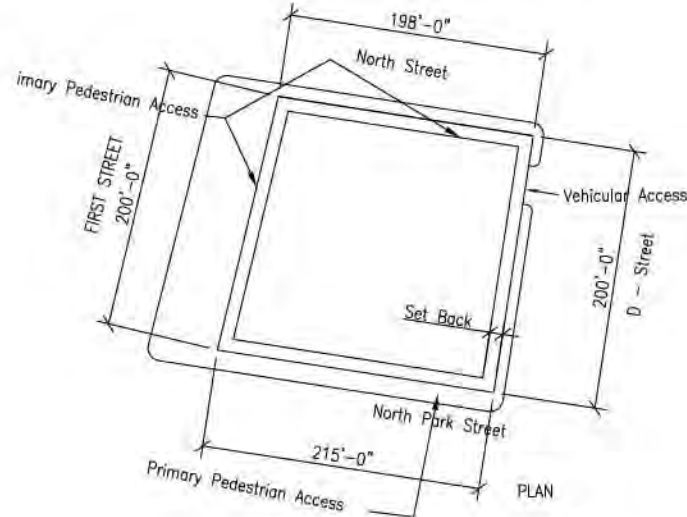

SAMPLE ENVELOPE

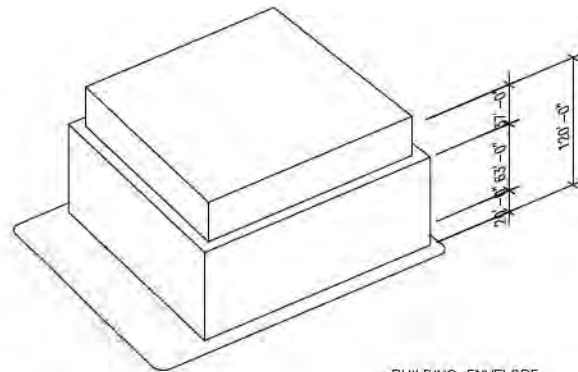

BUILDING ENVELOPE

North Point

Building K Guidelines

Approximate Dimensions

Parcel Size: 40,000 SF.

Gross Square Footage: (+/-) 265,000 SF.

Uses: Mixed Use, Residential or Commercial

No. of Dwelling Units: (+/-) 230

Parking Levels: Below grade, one half level above grade

Maximum Height of the Building: 120'

Lot Coverage: 100%

Primary Pedestrian Access: North Street, North Park Street, C - Court

Vehicular Access: D - Street

Design Guidelines

The ground level would address the primary streets and the green finger. The envelope is a 6-7 story perimeter building base and middle with a line of expression at the second floor level. The line of expression defines the base and is intended to humanize the scale of the buildings and create an intimate pedestrian experience. This should be achieved by means of material articulation or architectural detailing. Each Base, in its entirety, will be designed to give the appearance of greater height than any single floor in the Middle. The building mass beyond 6-7 stories shall be set back at least 10 ft. from the face of the base and middle. The orientation shall take advantage of the exposure to sun and spectacular views to the central park and the surroundings.

Building design shall make special consideration to the streetscape on the North Park Street to conform to the overall legibility of the street. It should contribute to the creation, scale and character of the green finger. Projections like bow windows, balconies and terraces are encouraged all sides, specifically on the south to take advantage of both sun and spectacular views to the central park and the surrounding areas.

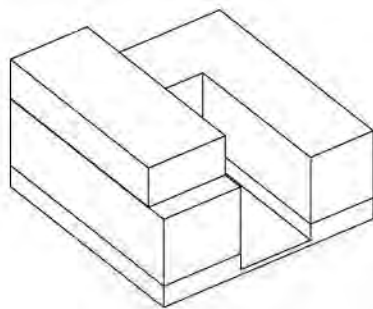
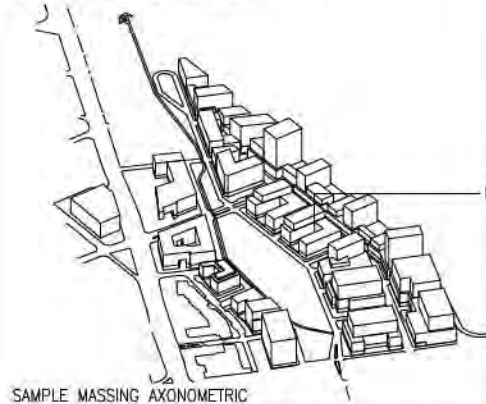
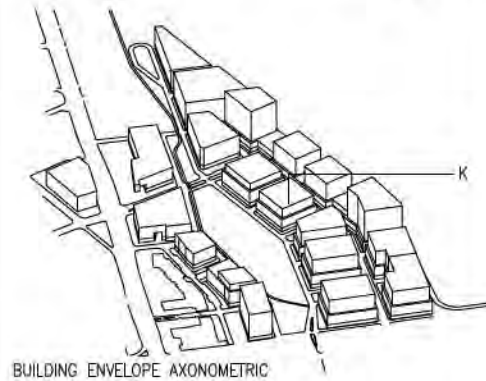
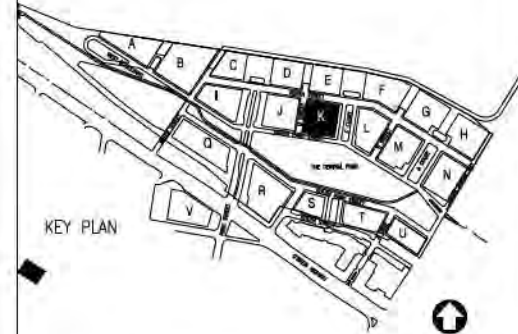
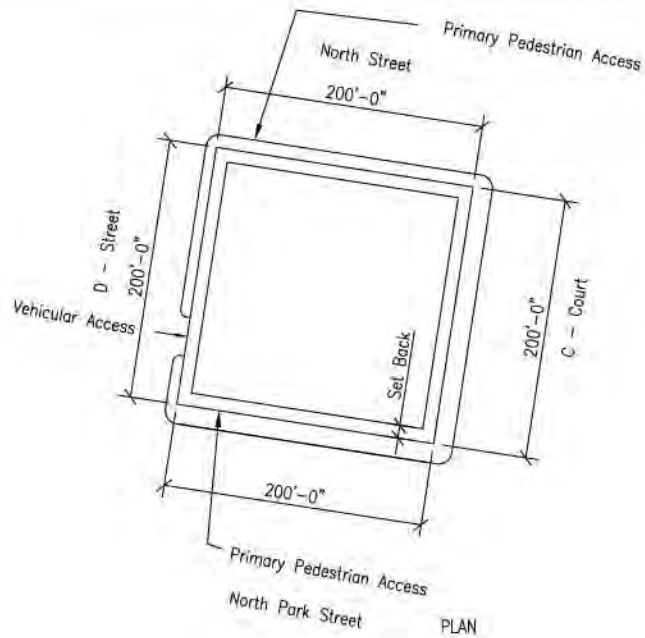

SAMPLE MASSING

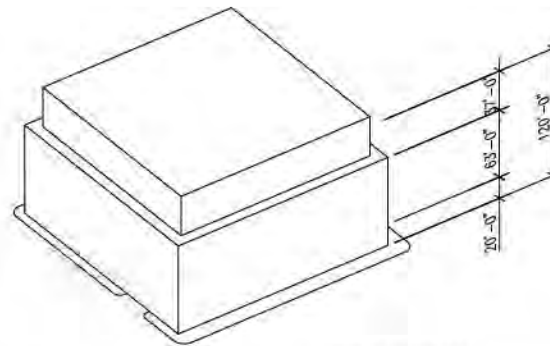

BUILDING ENVELOPE

North Point

Building L Guidelines

Approximate Dimensions:

Parcel Size: 37,000 SF.

Gross Square Footage:

Residential: (+/-) 124,000 SF.

Commercial: (+/-) 140,000 SF.

Uses: Mixed Use, Residential or Commercial

No. of Dwelling Units: 105

Parking: Below grade

Height of the Building: 150'

Lot Coverage: 100%

Primary Pedestrian Access: North Street, North Park Street, C - Court

Vehicular Access: B - Street

Design Guidelines:

The ground level would address the primary streets and the green finger with a high level of transparency. The envelope is a fusion of residential and commercial uses with 5 - 7 story perimeter building base and middle with a line of expression at the second floor level. The line of expression defines the base and is intended to humanize the scale of the buildings and create an intimate pedestrian experience. This should be achieved by means of material articulation or architectural detailing. Each Base, in its entirety, will be designed to give the appearance of greater height than any single floor in the Middle. The building mass beyond 5-7 stories shall be set back at least 10 ft. from the face of the base and the middle.

Building design shall make special consideration to the streetscape on the North Park Street to conform to the overall legibility of the street. It should contribute to the creation, scale and character of the green finger. Building design should also make special consideration to successfully integrating the two uses.

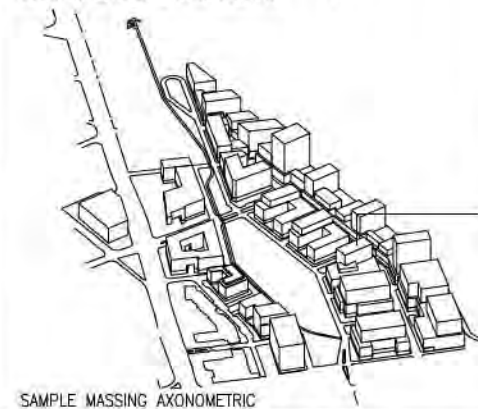
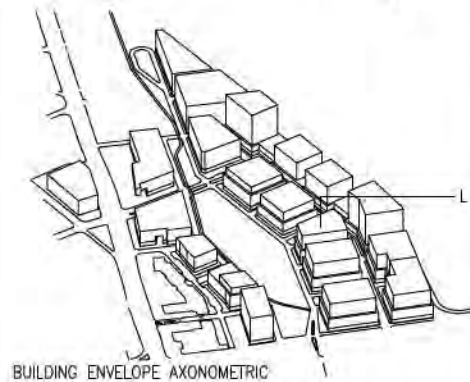
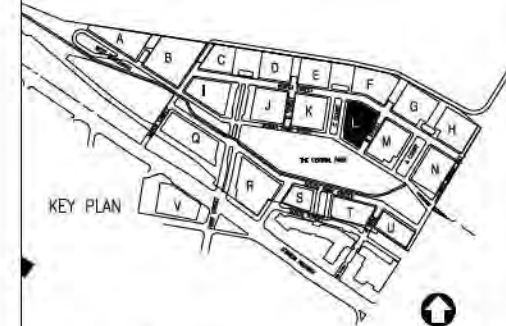
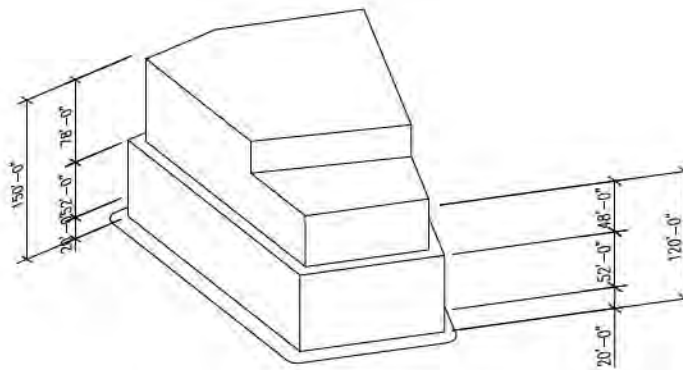
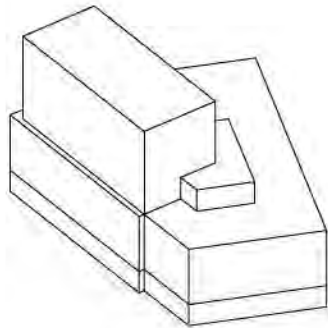
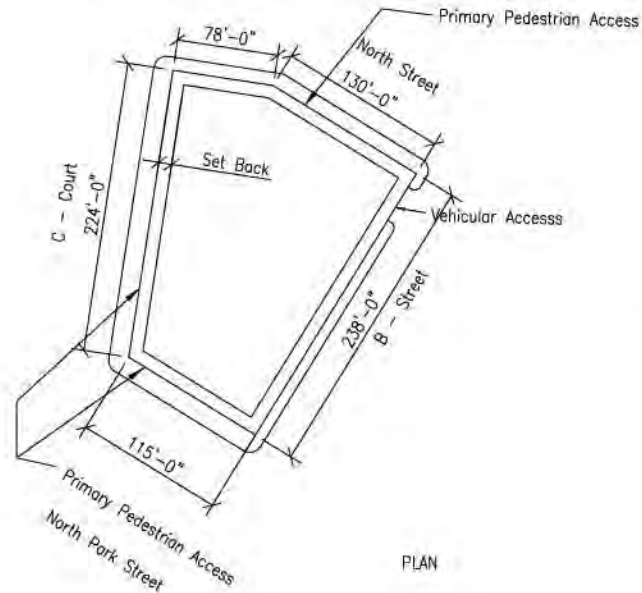

Building M Guidelines

Approximate Dimensions

Parcel Size: 43,000 SF.

Gross Square Footage: (+/-) 315,000 SF.

Uses: Mixed Use or Commercial

Parking Levels: Below grade, one half level above grade

Maximum Height of the Building: 150'

Lot Coverage: 100%

Primary Pedestrian Access: North Street, North Park Street, A-Court

Vehicular Access: B - Street

Design Guidelines

The ground level would address the primary streets and the court with a high level of transparency and high ceilings. The envelope will be a 5-story perimeter building base and middle with a tower of up to approximately 10 stories. A line of expression at the third floor level defines the base and is intended to humanize the scale of the buildings and create an intimate pedestrian experience. This should be achieved by means of material articulation or architectural detailing. Each Base, in its entirety, will be designed to give the appearance of greater height than any single floor in the Middle. Any building mass above this level shall be set back at least 10 ft from the face of the base and the middle. Any office oriented retail shall face the green finger, with a possibility of opening out onto it.

Building design shall make special consideration to the streetscape on the North Park Street to conform to the overall legibility of the street. Design should also contribute to the character and scale of the green finger to encourage informal interaction. Design shall also make a special attempt to create synergy and identity for the office cluster.

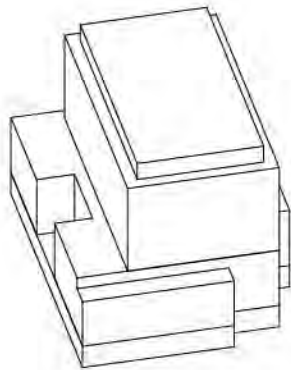
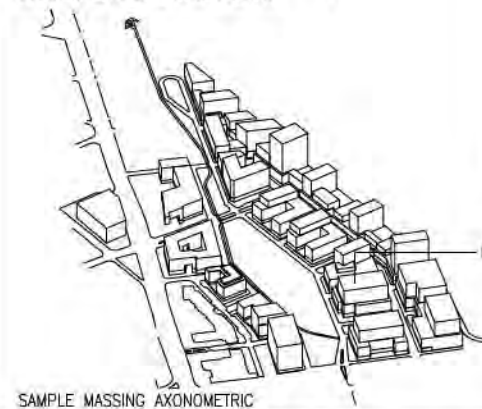
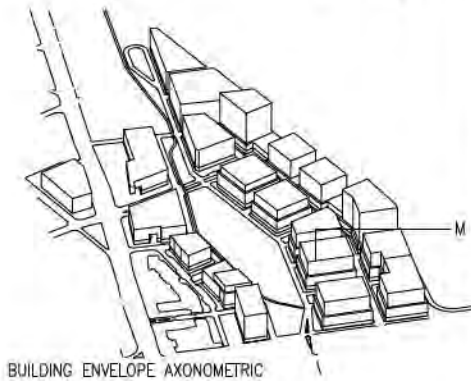
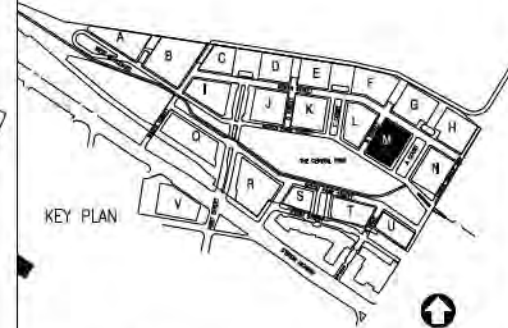
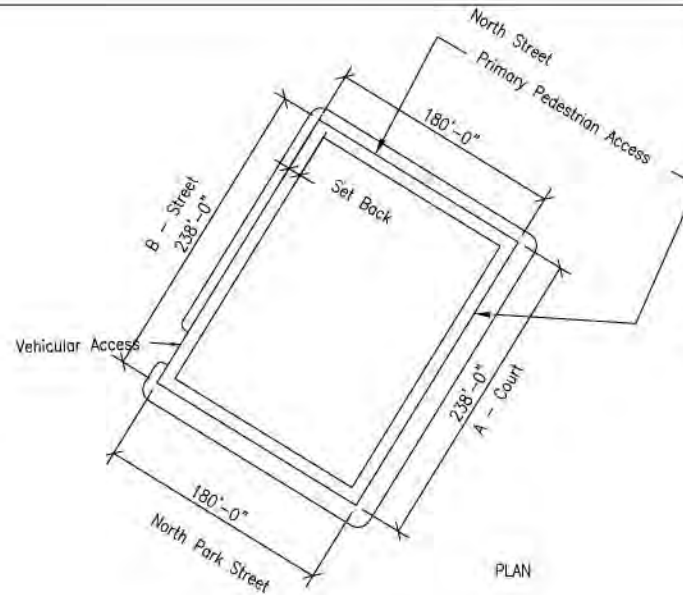

SAMPLE ENVELOPE

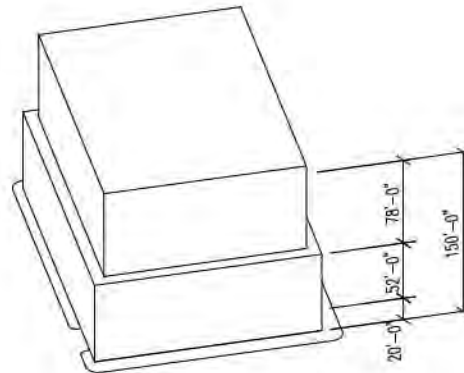

BUILDING ENVELOPE

North Point

Building N Guidelines

Approximate Dimensions

Parcel Size: 43,000 SF.

Gross Square Footage: (+/-) 338,000 SF.

Uses: Commercial

Parking Levels: Below grade, one half level above grade

Maximum Height of the Building: 150'

Lot Coverage: 100%

Primary Pedestrian Access: A-Court, North Park Street, Gilmore Bridge

Vehicular Access: Lower Bridge Street

Design Guidelines

The ground level would address the primary streets and the court with a high level of transparency and high ceilings. Entrances from the Gilmore Bridge at a higher level create an opportunity for enhanced public realm. The envelope will be a 5-story perimeter building base and middle. A line of expression at the third floor level defines the base and is intended to humanize the scale of the buildings and create an intimate pedestrian experience. This should be achieved by means of material articulation or architectural detailing. Each Base, in its entirety, will be designed to give the appearance of greater height than any single floor in the Middle. Any building mass above this level shall be set back at least 10 ft from the face of the base and the middle. Office oriented retail will mostly face the green finger, with a possibility of opening out onto it.

Building design should give a special consideration to connections from Gilmore Bridge to the site through the building. The sidewalk on the Gilmore Bridge may be extended and retail entrances may be created. The building design should make provisions to incorporate a public connection between the bridge and the site, by means of public atrium space, elevators and escalators. These efforts should also aim at the creation, character and scale of the green finger.

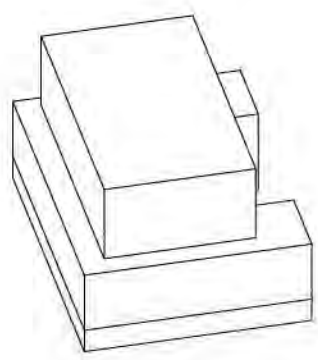
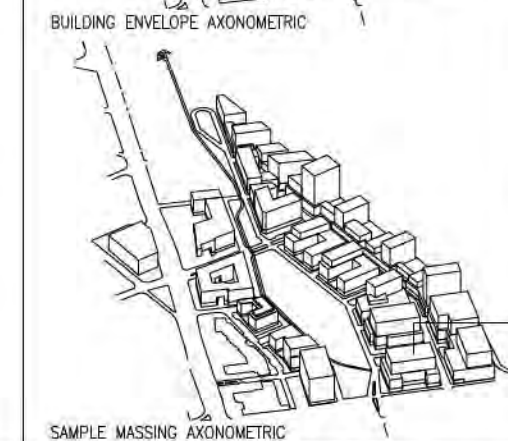
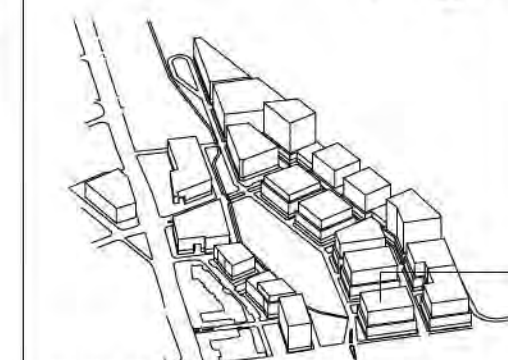
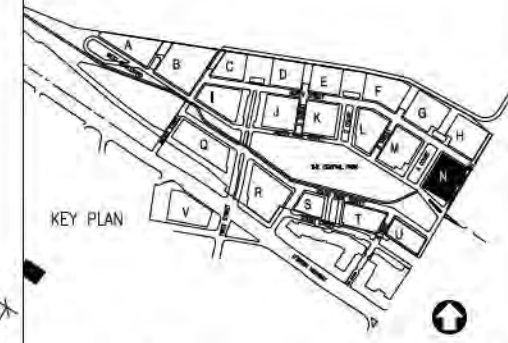
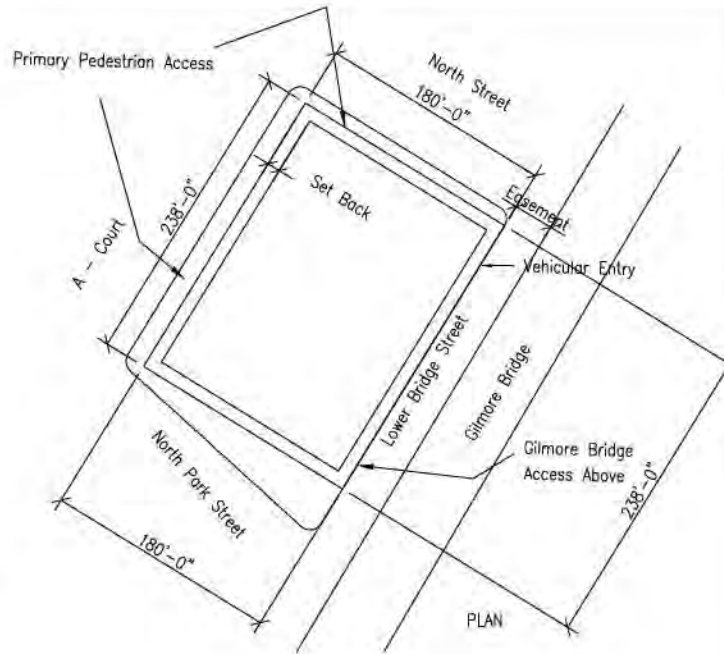

SAMPLE MASSING

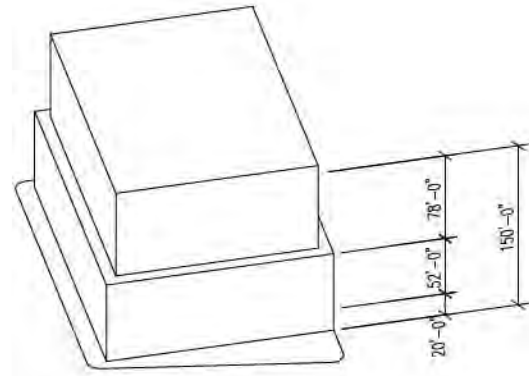

BUILDING ENVELOPE

North Point

Building Q Guidelines

Approximate Dimensions

Parcel Size: 50,000 SF.

Gross Square Footage

Residential: (+/-) 140,000 SF.

Commercial: (+/-) 150,000 SF.

Uses: Mixed Use or Commercial

No. of Dwelling Units: (+/-) 120

Parking Levels: Below grade, one half level above grade

Maximum Height of the Building: 85'

Lot Coverage: 100%

Primary Pedestrian Access: First Street, West Boulevard

Vehicular Access: Water Street

Design Guidelines

The ground floor would address primary streets with high level of transparency, and could include stores, restaurants, cafes and entrances to commercial and other public uses. The envelope will have a 6 story commercial building on the First Street and 6 - 7 story residential on the West Boulevard. A line of expression at the second/third floor level defines the base and is intended to humanize the scale of the buildings and create an intimate pedestrian experience. This should be achieved by means of material articulation or architectural detailing. Each Base, in its entirety, will be designed to give the appearance of greater height than any single floor in the Middle. The building mass on the First Street will be significantly set back from the street to allow for gracious setbacks. This will allow the retail, cafes and restaurants to open out onto these sidewalks.

Building design shall make special efforts to integrate multiple uses. It shall accommodate the new T Station to positively define the public realm. It should contribute to the activities, character and the scale of the proposed Lechmere Square. First Street is designed as a major transit transfer and retail hub with a focus on pedestrian movement. Building design shall make necessary considerations to accommodate these activities. It shall give special attention to interface with the T line to reduce noise and vibration by thoughtful building design and relevant acoustical treatments.

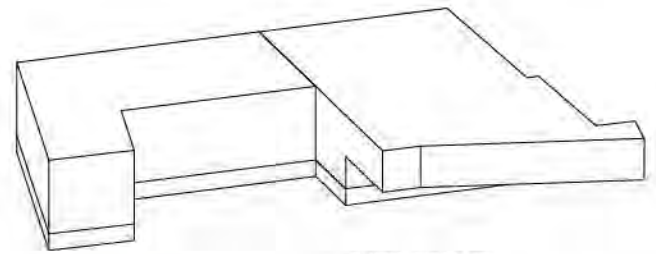
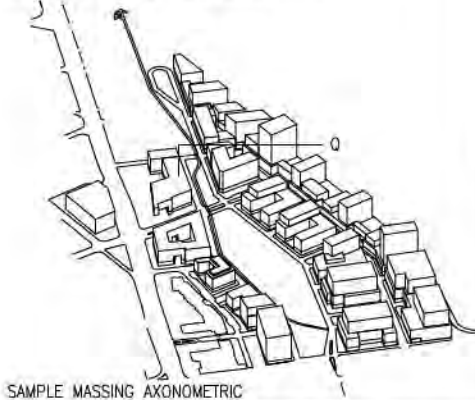
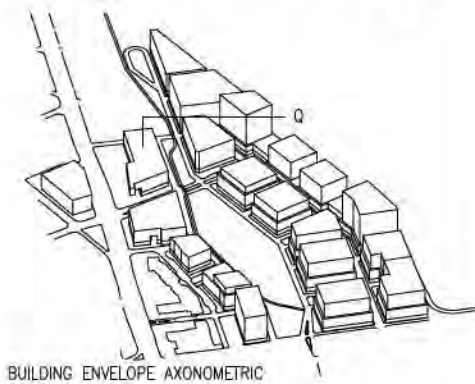
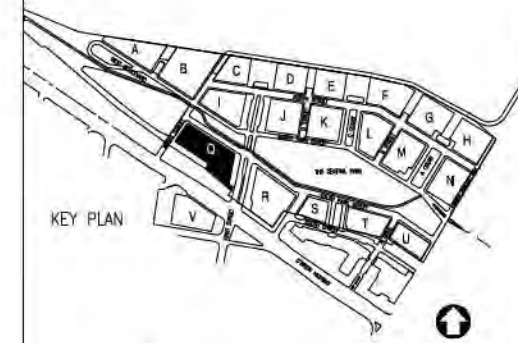
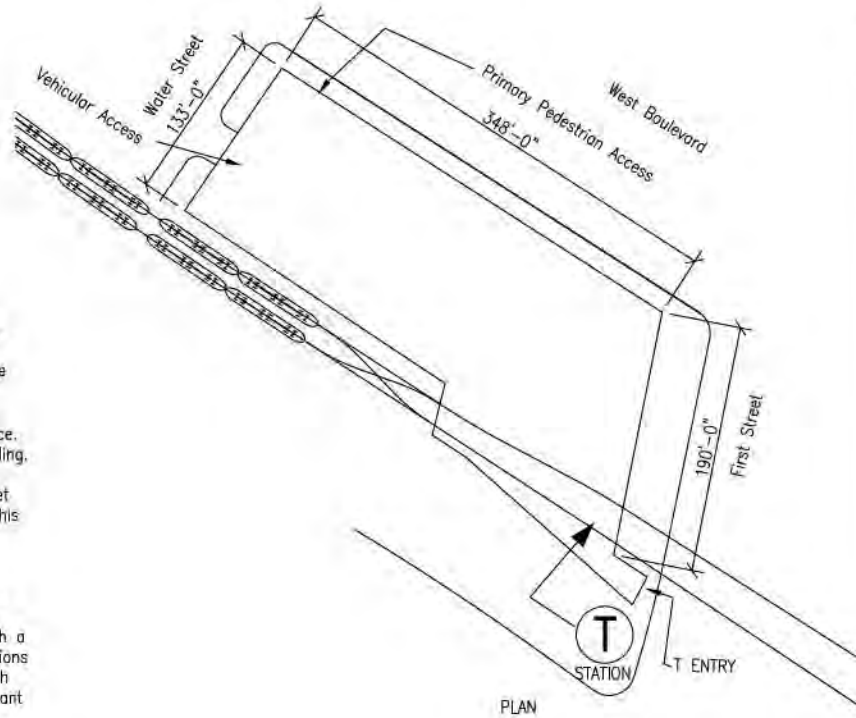

SAMPLE ENVELOPE

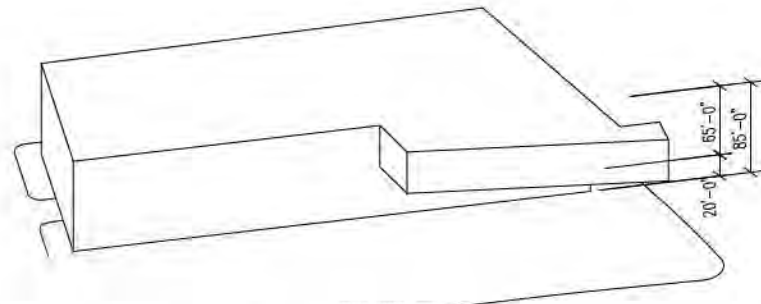

BUILDING ENVELOPE

North Point

Building R Guidelines

Approximate Dimensions

Parcel Size: 57,000 SF.

Gross Square Footage: (+/-) 271,000 SF.

Uses: Commercial

Parking Levels: Below grade, one half level above grade

Maximum Height of the Building: 85'

Lot Coverage: 100%

Primary Pedestrian Access: First Street, South Park Street, O'Brien

Vehicular Access: Relocated East Street

Design Guidelines

The ground floor would address primary streets with a high level of transparency, and could include stores, restaurants, cafes and entrances to the commercial and other public uses. The envelope will have a perimeter building of 6 stories. A line of expression at the third floor level defines the base and is intended to humanize the scale of the buildings and create an intimate pedestrian experience. This should be achieved by means of material articulation or architectural detailing. Each Base, in its entirety, will be designed to give the appearance of greater height than any single floor in the Middle. This will be set back significantly from First Street to allow for gracious sidewalks to allow the retail, cafes and restaurants to open out onto the street. Any building mass above the base and middle shall be set back at least 10 ft from the face of it. The tallest portion of the building will be along the O'Brien Highway and First Street to enhance the scale of new Lechmere Square.

Building design shall make special efforts to the creation and defining of the new Lechmere Square. It shall positively contribute to the activities, character and scale of the square. First Street is designed as a major transit transfer and retail hub with a focus on pedestrian movement. Building design shall make necessary consideration to accommodate these activities. It shall give special attention to interface with the T line to reduce noise and vibration by thoughtful building design and relevant acoustical treatments. Design shall make a special effort to respond to and integrate the adjoining Charles E. Smith development. It shall accommodate the location of Relocated East Street.

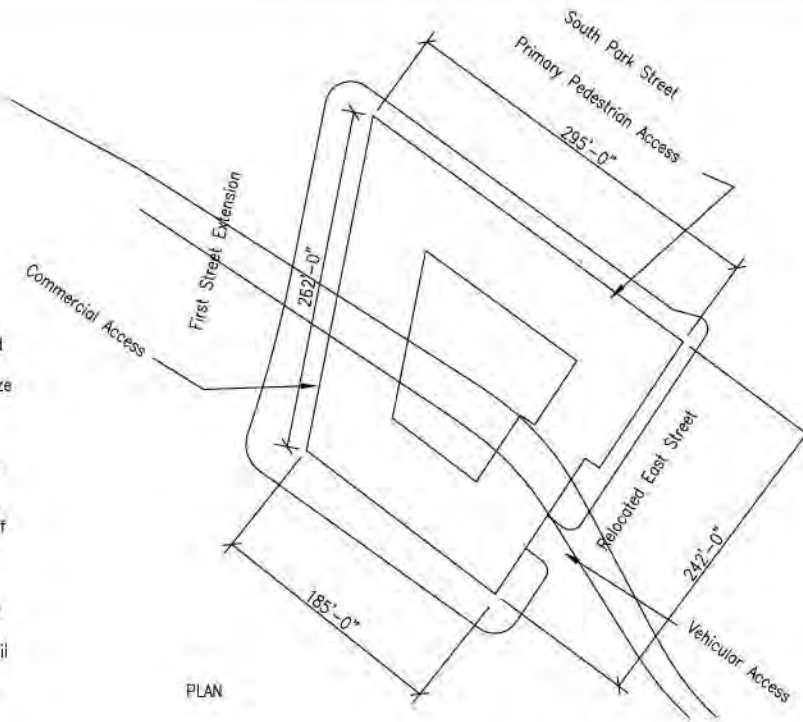

PLAN

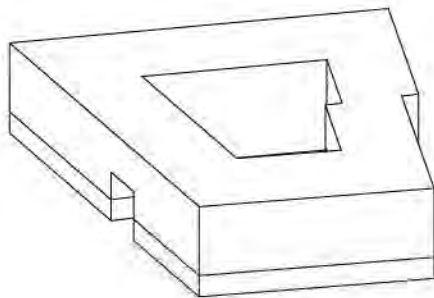

SAMPLE ENVELOPE

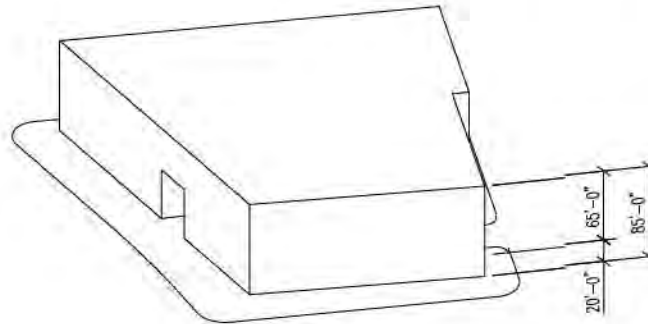

BUILDING ENVELOPE

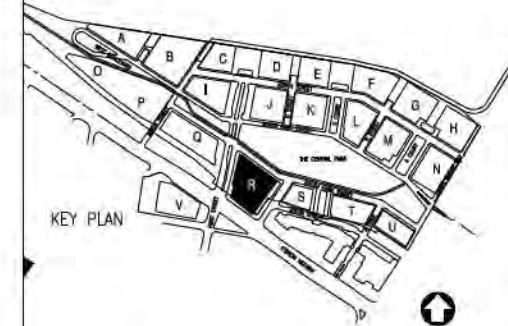

KEY PLAN

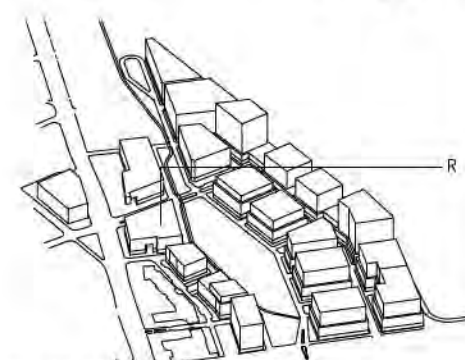

BUILDING ENVELOPE AXONOMETRIC

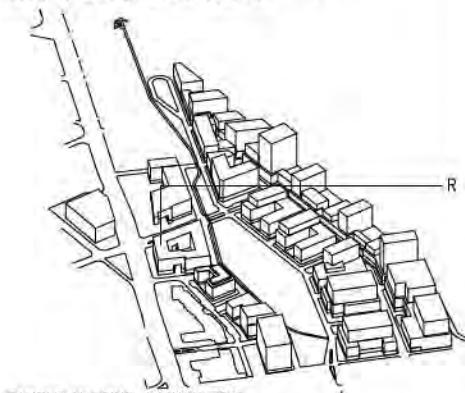

SAMPLE MASSING AXONOMETRIC

Building S Guidelines

Approximate Dimensions

Parcel Size: 19,500 SF.

Gross Square Footage: (+/-) 112,000 SF.

Uses: Mixed Use, Residential or Commercial

No. of Dwelling Units: (+/-) 95

Parking Levels: Below grade, one half level above grade

Maximum Height of the Building: 85'

Lot Coverage: 100%

Primary Pedestrian Access: South Park Street, C - Court

Vehicular Access: Relocated East Street

Design Guidelines

The envelope of the building is 6 - 7 story perimeter building with a line of expression at the second floor level. The line of expression defines the base and is intended to humanize the scale of the buildings and create an intimate pedestrian experience. This should be achieved by means of material articulation or architectural detailing. Each Base, in its entirety, will be designed to give the appearance of greater height than any single floor in the Middle. The first floor may be elevated on one-half level above grade parking.

Building design shall also give special consideration to the streetscape and scale of the South Park Street and conform to the overall legibility of the street. Projections like bow windows, balconies and terraces are encouraged on all sides to take advantage of both sun and spectacular views of the park. It should also contribute to the character and scale of the green finger. Building design shall make a special effort to respond to and integrate the adjoining Charles E. Smith development.

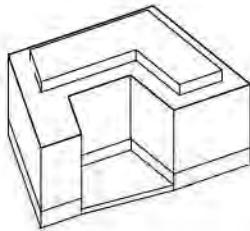
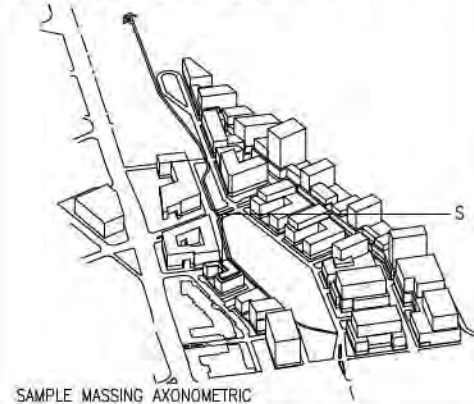
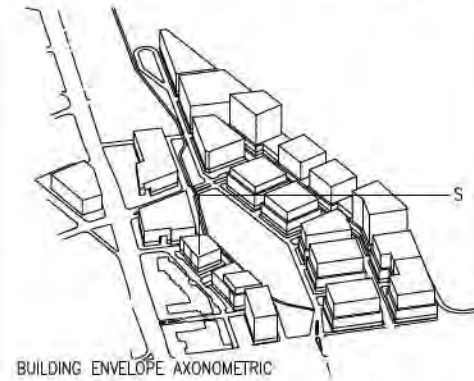
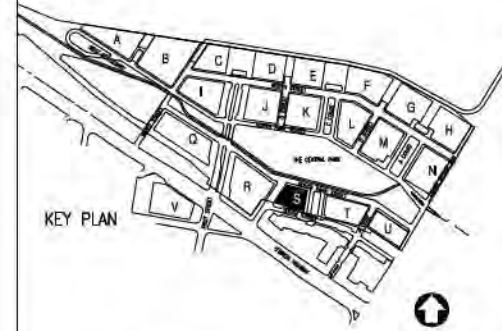
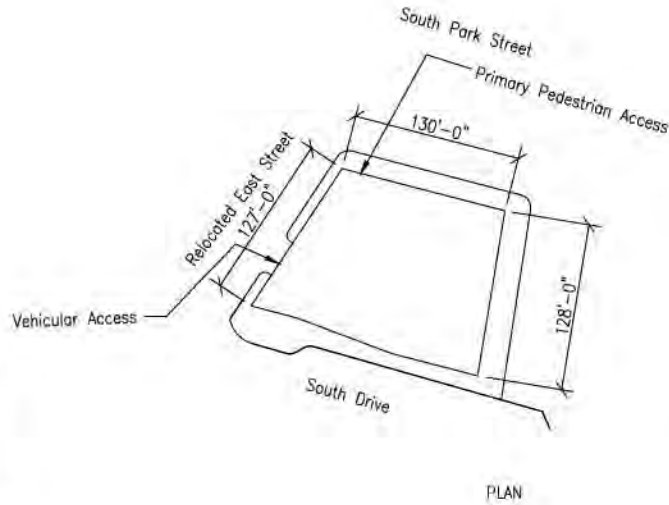

SAMPLE ENVELOPE

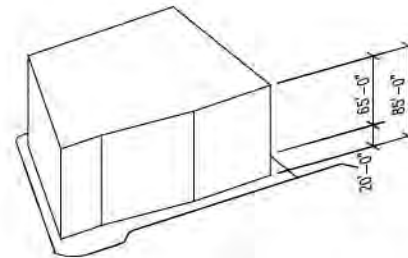

BUILDING ENVELOPE

North Point

Building T Guidelines

Approximate Dimensions

Parcel Size: 32,000 SF.
 Gross Square Footage: (+/-) 245,000 SF.
 Uses: Residential
 No. of Dwelling Units: (+/-) 210
 Parking Levels: Below grade, one half level above grade
 Maximum Height of the Building: 120'
 Lot Coverage: 100%
 Primary Pedestrian Access: South Park Street, C - Court
 Vehicular Access: A - Drive

Design Guidelines

The envelope of the building is 7 - 11 story perimeter building with a line of expression at the second floor level. The line of expression defines the base and is intended to humanize the scale of the buildings and create an intimate pedestrian experience. This should be achieved by means of material articulation or architectural detailing. Each Base, in its entirety, will be designed to give the appearance of greater height than any single floor in the Middle. The taller mass shall be concentrated towards the eastern side of the parcel and shall be set back by at least 10 ft. from the facade. The first floor may be elevated on one-half level above grade parking.

Building design shall also give special consideration to the streetscape and scale of the South Park Street and conform to the overall legibility of the street. Projections like bow windows, balconies and terraces are encouraged on all sides to take advantage of both sun and spectacular views of the park. It should also contribute to the character and scale of the the green finger. Building design shall make a special effort to respond to and integrate the adjoining Charles E. Smith Development.

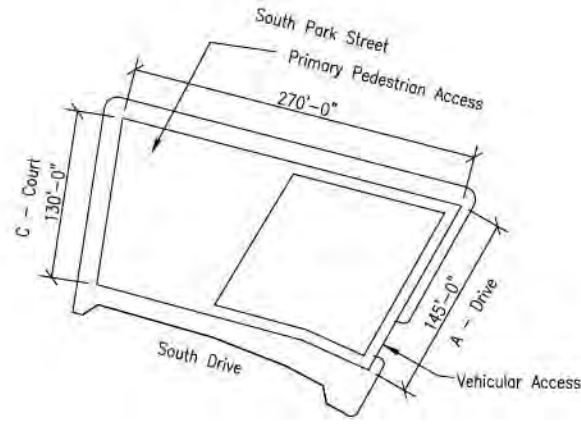

PLAN

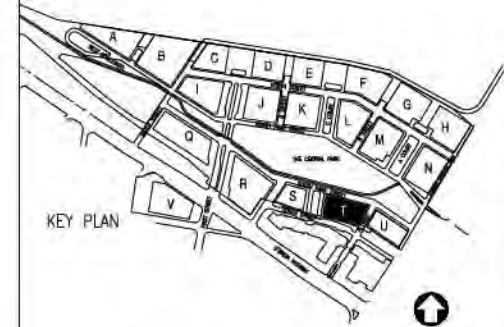

KEY PLAN

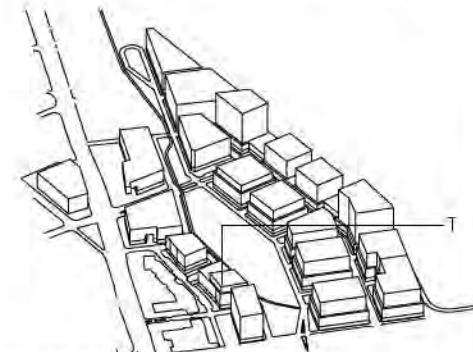

BUILDING ENVELOPE AXONOMETRIC



SAMPLE MASSING AXONOMETRIC

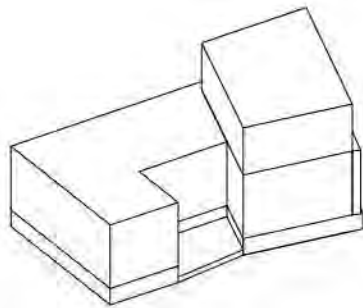

SAMPLE ENVELOPE

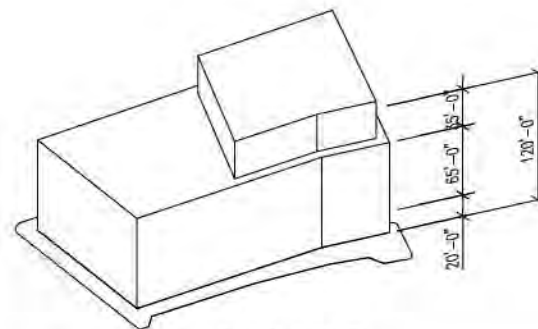

BUILDING ENVELOPE

North Point

Building U Guidelines

Approximate Dimensions

Parcel Size: 28,000 SF.
 Gross Square Footage: (+/-) 270,000 SF.
 Uses: Commercial
 Parking Levels: Below grade, above grade
 Maximum Height of the Building: 150'
 Lot Coverage: 100%
 Primary Pedestrian Access: South Park Street
 Vehicular Access: A - Drive

Design Guidelines

The ground level would address the primary streets with a high level of transparency and high ceilings. Entrances from the Gilmore Bridge at a higher level create an opportunity for enhanced public realm. The envelope will be a perimeter building of approximately 11 stories forming a strong base with a line of expression at the second floor level. A line of expression at the third floor level defines the base and is intended to humanize the scale of the buildings and create an intimate pedestrian experience. This should be achieved by means of material articulation or architectural detailing. Each Base, in its entirety, will be designed to give the appearance of greater height than any single floor in the Middle. Buildings shall set back 20 ft. (easement) from the Gilmore Bridge.

Building design should positively contribute to the streetscape on the South Park Street and take advantage of the views to the central park and surrounding areas. Building design shall make a special effort to respond to and integrate the adjoining Charles E. Smith Development.

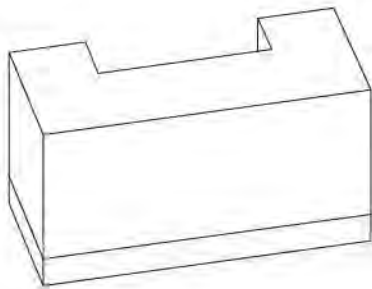

SAMPLE ENVELOPE

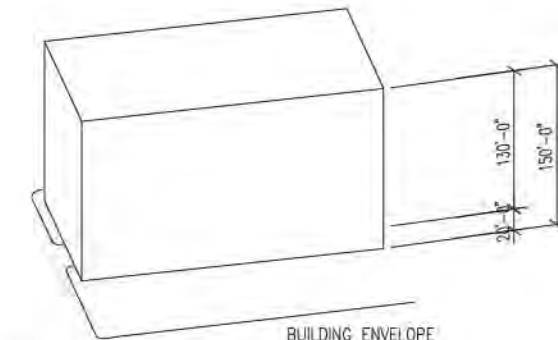

BUILDING ENVELOPE

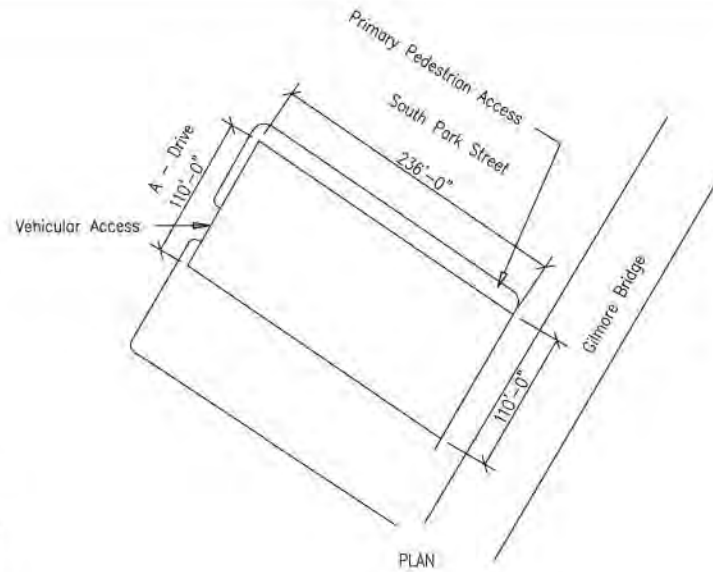

PLAN

KEY PLAN AND AXONOMETRIC

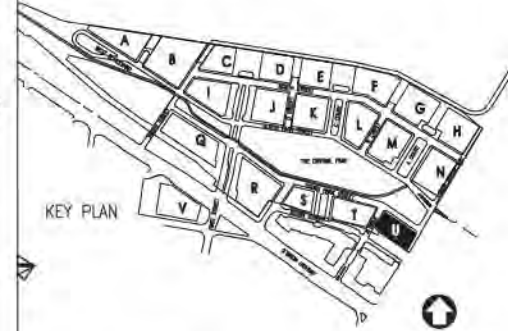

KEY PLAN

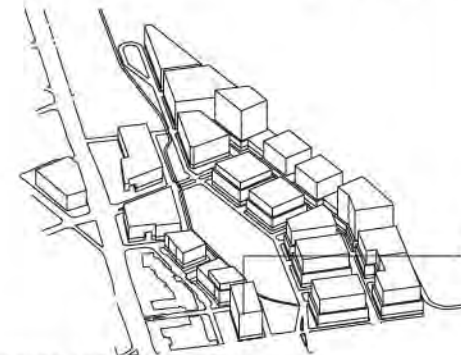

BUILDING ENVELOPE AXONOMETRIC



SAMPLE MASSING AXONOMETRIC

North Point

Greenberg Consultants Ltd.

cbt . . .

chilbertman.isackares.jrc



Building V Guidelines

Approximate Dimensions

Parcel Size: 72,500 SF.
 Gross Square Footage: (+/-) 180,000 SF.
 Uses: Mixed Use, Residential or Commercial
 No. of Dwelling Units: (+/-) 155
 Parking Levels: Below grade
 Maximum Height of the Building: 65'
 Lot Coverage: 100%
 Primary Pedestrian Access: First Street and Cambridge Street
 Vehicular Access: Cambridge Street

Design Guidelines

The ground floor would address primary streets with high level of transparency, and could include retail stores, restaurants and cafes. The envelope is a 3 - 6 story perimeter building. A line of expression at the third floor level defines the base and is intended to humanize the scale of the buildings and create an intimate pedestrian experience. This should be achieved by means of material articulation or architectural detailing. Each Base, in its entirety, will be designed to give the appearance of greater height than any single floor in the Middle. The building mass on First Street will be significantly set back from the street to allow for gracious sidewalks.

The frontage of the building on Lechmere Square provides an opportunity for unique building design. Building design shall give special consideration to the streetscape and scale of Lechmere Square and Cambridge Street. First Street is designed as a major transit transfer and retail hub with a focus on pedestrian movement. Building design shall make necessary considerations to accommodate these activities. The building design shall facilitate and enhance the important transition from the East Cambridge neighborhood to North Point, especially the pedestrian movement across O'Brien Highway to the new Lechmere T Station. Building design shall make a special effort to respond to and integrate with the nearby proposed residential project at One First Street.

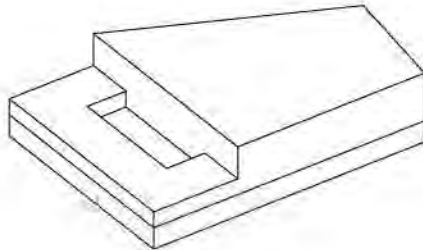

SAMPLE MASSING

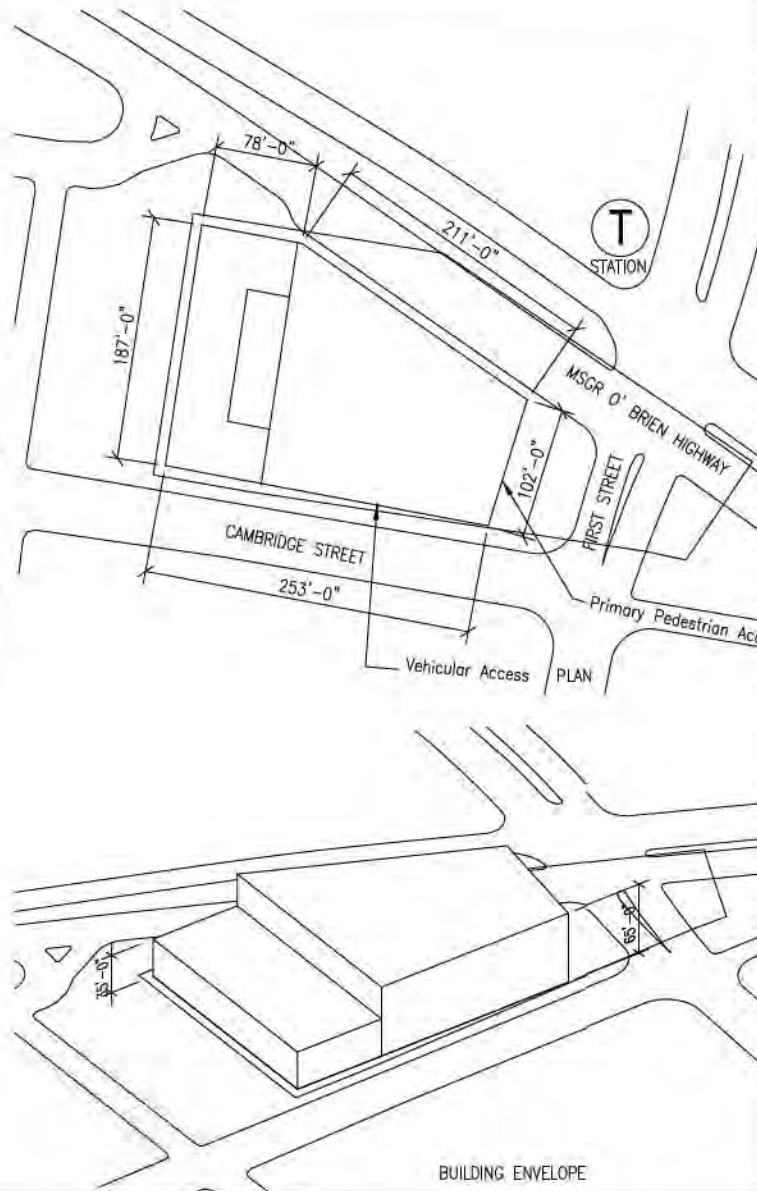

BUILDING ENVELOPE

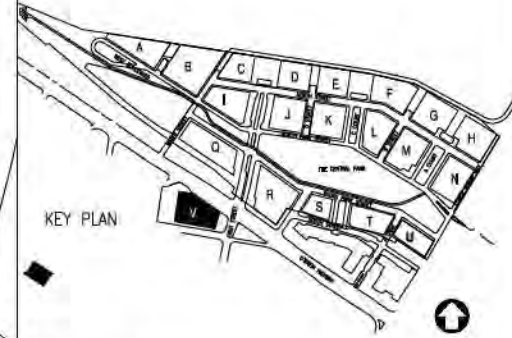

KEY PLAN

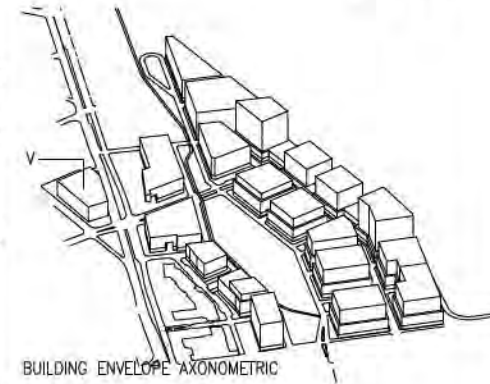

BUILDING ENVELOPE AXONOMETRIC

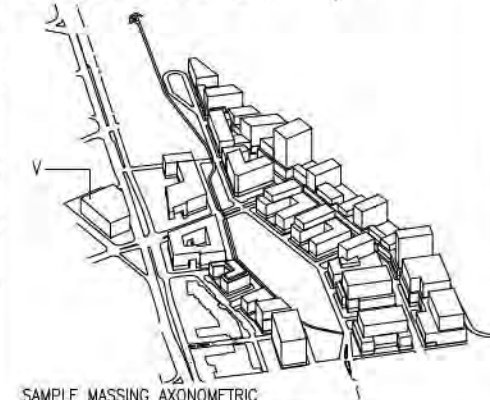

SAMPLE MASSING AXONOMETRIC

North Point

Eastern Cambridge Design Guidelines: North Point

North Point Site



Viewing from the south looking north:

This image captures the entire North Point site. The Museum Towers are the two larger structures located just east of the site. Immediately west of the Museum Towers is the Gilmore Bridge/Charlestown Avenue. Continuing west, North Point buildings 'U', 'N', and 'H' (running south to north) border the Gilmore Bridge. The buildings located just south of the Central Park are 'U' to 'Q' (east to west), north of the Central Park are buildings 'N' to 'I' (east to west), and buildings 'H' to 'A' border the northern edge of the site. Just south of the North Point site, and west of the Museum Towers, is the Charles E. Smith (CES) development. Immediately south of CES is the elevated MBTA Green Line. Following the Green Line west, along the southern edge of the site, the train enters buildings 'R' and 'Q', known as the New Lechmere Square. Just south of Lechmere Square and the Monsignor O'Brien Highway, is the existing MBTA Lechmere Station and proposed building 'V'.

Central Park



Viewing from the northern edge of the site looking east:

This image captures the new Central Park at North Point. Buildings 'U', 'T', and 'S' border the park on the right with building 'U' located the furthest from this view point. Immediately to the left of the park are buildings 'N', 'M', 'L', 'K', & 'J' (east to west). The Museum Towers are located in the distance on the other side of the Gilmore Bridge, which resides at the far end of the park.

Central Park & Green Fingers



Viewing from the south of buildings 'R', 'S', and 'T' looking north:

Building 'R' is located on the southwestern edge of this image. One can see the train tracks stem from Building 'R' traveling south of buildings 'S' and 'T', which are located just east of 'R'. North of these buildings is the Central Park. Beyond the park are buildings 'M', 'L', 'K', and 'J' (east to west) with an extended green finger between buildings 'K' & 'L'.

Gilmore Bridge



Viewing from the east looking west towards Somerville:

This picture captures the Gilmore Bridge and its relationship to the site. North Point buildings 'H', 'N', and 'U' (north to south) flank the Gilmore Bridge. The new Central Park stems from beneath the bridge between buildings 'N' and 'U'.

First Street Extension/New Lechmere Station



Viewing from the south of Lechmere Square looking north:

This picture captures the First Street Extension and the new Lechmere Square. First Street runs from the southern border of this image, under the new MBTA Green Line tracks and between buildings 'Q' and 'R', through the Central Park to the northern edge of the site.