

CAMBRIDGE DISCOVERY PARK

APPLICATION TO CAMBRIDGE PLANNING BOARD
FOR MINOR AMENDMENT NO. 5 TO
PLANNING BOARD MASTER PLAN SPECIAL PERMIT PB#198

AND FOR DESIGN REVIEW OF BUILDING 400-500



20 & 40 Acorn Park Drive, Cambridge, MA

Volume I – Narrative Materials

March 17, 2016

Submitted by

BHX, LLC

Trustee of Acorn Park Holdings Realty Trust

c/o The Bulfinch Companies, Inc.

250 First Avenue, Suite 200

Needham, MA 02494

Tel: 781.707.4000

Fax: 781.707.4001



Contents

Project Team List.....	1
Summary of Requested Approvals.....	3
Background and History.....	4
Arthur D. Little Company’s Research Campus.....	4
Developing a Shared Vision of the Future.....	5
Implementation of the Shared Vision Begins.....	6
Where We Are Today.....	8
Master Plan Special Permit Criteria for Amendments to Master Plan.....	10
The Building 400-500 changes are below the Minor Amendment thresholds.....	11
The Building 400-500 changes are allowed by minor amendment.....	13
The Building 400-500 changes do not require a major amendment to the master plan.....	14
Design Review of Buildings 400-500.....	15
Compliance with the Cambridge Discovery Park Master Plan Special Permit Design Guidelines	15
Building 400-500 Design Details.....	16
a. Open space and circulation design.....	16
b. Land use.....	17
c. Elements of form.....	17
Compliance with other Master Plan Special Permit conditions.....	24
a. Preliminary submission of building design.....	24
b. Interior courtyard concerns.....	24
c. Pedestrian access to Belmont.....	26
d. Efficient use of natural and energy resources.....	26
e. City Noise Ordinance.....	28
Possible Phased Construction of Building 400-500.....	29
Dimensional Form – Building 400-500.....	31
Dimensional Form – Existing plus Building 400-500 and Garage B.....	33

Project Team List

OWNER

BHX, LLC, Trustee of
ACORN PARK HOLDINGS
REALTY TRUST,
c/o Robert A. Schlager, CPM
ras@bulfinch.com
250 First Avenue, Suite 200
Needham, MA 02494-2805
Tel: 781.707.4000, x122
Fax: 781.707.4001

ARCHITECT

ADD Inc, now with Stantec
311 Summer Street
Boston, MA 02210
Tel: 617.234.3100
Fax: 617.661.7118
Larry Grossman, AIA
lgrossman@stantec.com
Eric Weyant, AIA
eweyant@stantec.com

MEP / FP ENGINEER

AHA Consulting Engineers
10 Maguire Road, Suite 121
Lexington, MA 02421
Tel: (781) 372-3000
Fax: (781) 372-3100
Martin Holloran
Marty_Holloran@aha-engineers.com

STRUCTURAL ENGINEER

Simpson Gumpertz & Heger, Inc.
41 Seyon Street
Building #1, Suite 500
Waltham, MA 02453
Tel: (781) 907-9000
Fax: (781) 907-9009
Pedro Sifre, Project Engineer, x377
pjsifre@sgh.com

DEVELOPER

The Bulfinch Companies, Inc.
250 First Avenue, Suite 200
Needham, MA 02494-2805
Tel: 781.707.4000
Fax: 781.707.4001
www.bulfinch.com
Robert A. Schlager, CPM
ras@bulfinch.com
Mark R. DiOrio, Esq.
mrd@bulfinch.com

CIVIL COORDINATOR

Paul Finger Associates
281 Winter Street
Waltham, MA 02451-8740
Tel: (617) 647-4900
Fax: (781) 647-4924
Cell: (508) 954-6302
Paul Finger, RLA
pfinger@pfai.net

GEOTECHNICAL ENGINEER

McPhail Associates
30 Norfolk Street
Cambridge, MA 02319
Tel: (617) 868-1420
Fax: (617) 868-1423
www.mcphailgeo.com

CIVIL/SURVEY ENGINEERS

BSC Group
15 Elkins Street
Boston, MA 02127
Tel: (617) 896-4300
Fax: (617) 896-4301
Dave Biancavilla, P.E., LEED AP, Project
Manager
DBiancavilla@bscgroup.com



TRANSPORTATION ENGINEER

Vanasse & Associates, Inc.
10 New England Business Center Drive
Suite 314
Andover, MA 01810-1066
Tel: (978) 474-8800
Fax: (978) 688-6508
Giles Ham, P.E.
gham@rdva.com
Scott Thornton, P.E.
sthornton@rdva.com

NOISE CONSULTANT

Acentech
33 Moulton Street
Cambridge, MA 02319
Tel: (617) 499-8000
Fax: (617) 499-8074
Jeff Fullerton
jfullerton@acentech.com

CODE CONSULTANT

Remmer Consulting Engineers
18 John Street Place
Worcester, MA 01609
Tel: (508) 756-2777
Fax: (508) 756-3840
Cell: (617) 719-7300
Norton Remmer, P.E.
Norton@remmerconsulting.com

WETLANDS SCIENTIST

BSC Group
33 Waldo Street
Worcester, MA 01608
Tel: (508) 792-4500
Fax: (508) 792-4509
Ingeborg E. Hegemann, PWS
Senior Vice President
ihegemann@bscgroup.com

LEGAL COUNSEL

Dain, Torpy, Le Ray, Wiest & Garner, P.C.
745 Atlantic Avenue, 5th Floor
Boston, MA 02111
Tel:(617) 542-4880
Fax: (617) 542-4808
Charles N. Le Ray, Attorney & LEED AP
cleray@daintorpy.com



Summary of Requested Approvals

BHX, LLC, as Trustee of Acorn Park Holdings Realty Trust (“Bulfinch”), is preparing to undertake the next step in the phased redevelopment of Cambridge Discovery Park, the former Arthur D. Little Company campus in the northwest corner of Cambridge. Bulfinch seeks approval to combine the previously-approved Buildings 400 & 500 into a single building whose upper stories will span Discovery Way, a private, internal roadway.

Bulfinch is requesting Minor Amendment No. 5 to Master Plan Special Permit PB#198 (granted by the Planning Board on October 19, 2004), as amended by Minor Amendment No. 1 (granted by the Planning Board on March 1, 2005), Minor Amendment No. 2 (granted by the Planning Board on October 20, 2009), Major Amendment No. 3 (granted by the Planning Board on October 21, 2014), and Minor Amendment No. 4 (also granted by the Planning Board on October 21, 2014) (as amended, the “Master Plan Special Permit”).¹ This approval is required to make minor modifications to the previously-approved footprints of Buildings 400 and 500, and to add an upper-level connection between the buildings at the third through fifth stories.

Bulfinch also seeks Master Plan Special Permit design review of the combined Building 400-500.

Finally, Bulfinch is seeking Planning Board approval to potentially construct Building 400-500 in two phases.

¹ The Master Plan Special Permit amendments are numbered sequentially, without regard to whether an amendment is major or minor. Thus, amendments 1, 2, and 4 are minor, while amendment No. 3, which authorized the development of Building 600 as a hotel, was deemed a “major” amendment.



Background and History

Arthur D. Little Company's Research Campus

Beginning in 1952, and continuing for more than three decades thereafter, the Arthur D. Little Company (“ADL”) built a sprawling, utilitarian research campus along Acorn Park Drive. ADL constructed several buildings on the south side of Acorn Park Drive, next to the Little River. Those buildings were barely outside the subsequently-adopted Wetlands Protection Act’s 25-foot Riverfront Area. As such, they were much closer to the river than would now be acceptable from a planning or environmental standpoint. Among these was ADL’s tallest building, the six-story former Building 20.

ADL also leased adjacent land along the eastern side of Acorn Park Drive from the former Metropolitan District Commission (“MDC,” now part of the Department of Conservation and Recreation (“DCR”)). With the MDC’s approval, ADL filled wetlands and built a parking lot with 454 surface parking spaces on this MDC land. By the mid-1990s, ADL’s campus had grown to eleven buildings containing approximately 416,000 square feet of gross floor area, with 1,052 surface parking spaces (including the 454 on MDC land).



Aerial view of former ADL Campus, circa 2000

In 1999, ADL sold its campus (including undeveloped land in Cambridge and Belmont), while remaining as the sole tenant. In November 2000, Bulfinch acquired the approximately 26.5-acre Cambridge portion of the former ADL property. At that time, ADL leased and occupied the entire campus.

Shortly thereafter, financial difficulties led to ADL filing for bankruptcy. In its bankruptcy proceedings, ADL voided its lease of the campus, leaving Bulfinch without a tenant. Two new companies emerged from ADL's ashes, TIAX, LLC and Nuvera Fuel Cells, Inc. For a few years, these companies remained as tenants, but, together, only occupied about half of the campus. Today, neither company remains at Cambridge Discovery Park.

Developing a Shared Vision of the Future

When Bulfinch acquired the property, the approximately 26.5-acre campus was zoned as Office 2. By right, the Cambridge Zoning Ordinance allowed a gross floor area of up to approximately 1,500,000 square feet (more than three times the approximately 416,000 square feet that Arthur D. Little Company had built). Many in the community felt that a tripling of the gross floor area at this location would have been excessive. Bulfinch, the Cambridge City Council, the Community Development Department, the Planning Board, and numerous other interested parties worked together collaboratively to develop a mutually-satisfactory downzoning proposal known as the Alewife Petition.

Many stakeholders wanted to see the surface parking area on the MDC land restored to natural conditions. Many stakeholders also wanted to see the area between Acorn Park Drive and the Little River—the so-called Little River Area—restored to natural conditions. There was widespread acknowledgement that, given the absence of public funding, the funds needed for these restoration efforts would need to be generated through private redevelopment of the campus. Eventually, a consensus vision emerged: the maximum allowed gross floor area for uses other than structured parking would be reduced to 916,000 square feet, and the developed footprint would be constrained to the area north and west of Acorn Park Drive. The Little River Area and MDC parking lot area would be restored to natural conditions. Finally, the maximum number of parking spaces allowed or required (for any mixture of uses) was set at 1,052, the historic total number of spaces on ADL's campus and the MDC land. After a public hearing, the Planning Board unanimously recommended adoption of the Alewife Petition. On September 24, 2001, the City Council unanimously enacted the Alewife Petition as Section 17.40 of the Zoning Ordinance.²

The Special District 4 rezoning established a process for the phased redevelopment of the former Arthur D. Little Company campus. Under this process, increases in the total amount of gross floor area are coupled with specific milestones for the restoration and preservation of certain natural areas. In Phase One, Bulfinch was allowed to increase the total gross floor

² CZO § 17.40 created two new special districts, Special District 4 encompassing Bulfinch's 26.5-acre property, and Special District 4A encompassing several neighboring properties between Cambridge Discovery Park and the Concord Turnpike. Much of Special District 4A now has been redeveloped as the Vox on Two multifamily residential project.

area from the approximately 416,000 square feet present in 2001 to as much as 666,000 square feet, plus up to 250,000 square feet of structured parking.³ During this initial phase, Bulfinch was required to develop and obtain Planning Board approval of a plan to restore to natural conditions the former MDC parking lot area and the Little River Area, such that at least ninety percent of these areas would consist of Green Area Open Space.

Under the Special District 4 zoning, in Phase Two Bulfinch may increase the total gross floor area to as much as 850,000 square feet of gross floor area, plus up to 400,000 square feet of structured parking. During this phase, Bulfinch would be required to restore the former MDC parking lot area, demolish five of the buildings formerly located in the Little River Area, and restore to natural conditions at least fifty percent of the Little River Area. In fact, Bulfinch fully restored the former MDC parking lot area to natural conditions in conjunction with the construction of the first new building, Building 100, for Smithsonian Astrophysical Observatory. Building 100 opened in late 2005. Bulfinch also demolished all of the former Arthur D. Little Company buildings in the Little River Area ahead of schedule and has restored that area to natural conditions. In conjunction with the construction of Building 200/300, Bulfinch also demolished the remaining former Arthur D. Little Company buildings north and west of Acorn Park Drive. Thus, while Cambridge Discovery Park was within Phase One of the Special District 4 redevelopment process, Bulfinch met all of the Phase Two milestones.

In Phase Three under the Special District 4 zoning, Bulfinch may increase the total gross floor area to as much as 900,000 square feet, plus up to 400,000 square feet of structured parking.⁴ Also in this phase, Bulfinch would be required to complete the restoration of the Little River Area, had it not already done so.

Implementation of the Shared Vision Begins

After ADL's collapse, Bulfinch actively sought new tenants for Cambridge Discovery Park. In 2004, Bulfinch signed up the Smithsonian Astrophysical Observatory ("Smithsonian") as the first new tenant. Smithsonian wanted to stay in Cambridge while consolidating several scattered facilities into a purpose-built building to satisfy its particular needs. With a tenant on board, Bulfinch proceeded with implementation of the shared vision codified in Section 17.40 of the Zoning Ordinance.

On August 26, 2004, Bulfinch filed its Cambridge Discovery Park Master Plan Special Permit application with the Planning Board. The application was accompanied by seven volumes of supporting materials including a Flood Storage Report, Drainage Report, and Flood Storage Plan set, all prepared by the BSC Group; Graphics and Renderings prepared by ADD Inc; and a Transportation Impact Study prepared by Vanasse & Associates, Inc. Bulfinch sought several forms of zoning review and relief for the master plan:

³ The separate gross floor area limits for structured parking were established in recognition that the high water table and low topography at Cambridge Discovery Park preclude the construction of underground parking.

⁴ The Master Plan Special Permit approves up to 819,916 square feet of gross floor area, plus up to 390,000 square feet of structured parking.



- A Project Review Special Permit under Section 19.20 of the Zoning Ordinance,
- A Flood Plain Overlay District special permit under Section 20.73 of the Zoning Ordinance,
- Special District 4 yard reduction under Section 17.42.2 of the Zoning Ordinance,
- Special District 4 building height increase (to 80 feet) under Section 17.42.3 of the Zoning Ordinance; and
- Parkway Overlay District Design Review.

On September 21, 2004, the Planning Board held a public hearing on the application. Thereafter, Bulfinch submitted a Supplemental Filing responding to questions raised by the Planning Board. On October 19, 2004, the Planning Board voted to grant the requested zoning reviews and relief. That decision also granted specific approval and design review approval of a new Building 100 (the Smithsonian's new home) and of Garage A.

On February 25, 2005, after Smithsonian fell short on funding for its Giant Magellan Telescope (GMT) project, Bulfinch requested a Minor Amendment to the decision, to defer construction of the GMT annex to Building 100. Bulfinch also sought permission to defer construction of Garage A until the total gross floor area (excluding parking) at Cambridge Discovery Park exceeded 526,000 square feet. On March 1, 2005, the Planning Board granted the requested Minor Amendment No. 1. Construction of the GMT annex remains deferred unless and until the Smithsonian obtains funding for its GMT project. Construction of Building 100 was completed in late 2005.

In 2009, Bulfinch's ongoing efforts to attract new tenants to Cambridge Discovery Park were again rewarded. Forrester Research decided to consolidate its scattered Cambridge offices into a new, build-to-suit headquarters. On October 20, 2009, the Planning Board granted Minor Amendment No. 2 for the Forrester Research project, which fixed the locations of conjoined Buildings 200 and 300, shifted the location of a proposed internal connection between Acorn Park Drive and the internal roadway (known as Discovery Way) from between Building 200 and 300 to between Buildings 100 and 200, and allowed up to 731 parking spaces in Garage A and on grade.



Present day view of Cambridge Discovery Park campus with Vox on Two behind

In 2014, representatives of Marriott hotels approached Bulfinch with a proposal to build one of the country's first AC Marriott hotels at Cambridge Discovery Park. This approximately 82,000 square foot hotel replaced the approximately 120,000 square foot office/research formerly proposed as Building 600. Because the hotel project required a "decoupling" of proposed buildings 500 and 600, and because, although allowed by right in the underlying zoning, a hotel use was not contemplated when the Planning Board granted the original master plan special permit, these changes required a "major" amendment to the master plan special permit. On October 21, 2014, the Planning Board granted Major Amendment No. 3 for the hotel project. The AC Marriott hotel is currently under construction.

In conjunction with the approval of Building 600 as a hotel, Bulfinch also sought a minor amendment for the altered location of future Building 500, now decoupled from Building 600, and related changes to the master plan. On October 21, 2014 the Planning Board granted Minor Amendment No. 4 and granted design review for the revised Buildings 400 and 500.

Where We Are Today

Bulfinch has removed the surface parking lot from the adjacent Department of Conservation and Recreation land, and has restored that area to natural conditions. With DCR's approval, Bulfinch created a pedestrian / bicycle path across that area, providing a connection from Cambridge Discovery Park to the MBTA Alewife station. At DCR's request, Bulfinch also created a small parking lot on DCR's land with approximately two dozen spaces for visitors

to the Alewife Reservation who need a place to park while bird watching, canoeing or kayaking on the Little River, or otherwise enjoying the Reservation.⁵

The Little River area has been fully restored to natural conditions. That area now includes an open meadow area and a pond, which receives and treats stormwater from the developed area on the north side of Acorn Park Drive. A smaller pond created just west of Building 100 similarly receives and treats stormwater from that area.

Arthur D. Little Company operated a private, underground, sewer pumping station in the Little River Area, near the edge of the Little River. Bulfinch built a replacement pumping station, located closer to Acorn Park Drive. Bulfinch has agreed to transfer ownership of the new pumping station to the Cambridge Department of Public Works during the next few years.

Bulfinch has worked with an affiliate of Criterion Development Partners, the developer of the 227-unit Vox on Two residential project (formerly known as the Residences at Alewife) on the site of the former Faces discotheque, to coordinate utility infrastructure and pedestrian access. Wastewater from that project discharges to the City's sewer system via the new pumping station at Cambridge Discovery Park. A pedestrian / bicycle easement allows Vox on Two residents to cross Cambridge Discovery Park to the public sidewalks along Acorn Park Drive, from which they can access the Alewife MBTA station via the path across the DCR land.

Today, Bulfinch has constructed three of the six buildings for which the Planning Board gave conceptual approval in the Cambridge Discovery Park Master Plan Special Permit, and a fourth (as modified to a hotel) is under construction. Building 100 remains Smithsonian's Cambridge home. Forrester Research occupies Building 200/300. Parking Garage A also has been built. The Planning Board approved the design of Garage B as part of the design review of Buildings 400 and 500. This application, for a minor amendment to allow the upper-level connection of Buildings 400 and 500, and for design review of the combined building encompass the remaining master plan elements.

⁵ These spaces are outside Special District 4, and do not count toward the 1,052 parking spaces allowed within Special District 4 by Section 17.43.1 of the Zoning Ordinance. There is no on-street parking along Acorn Park Drive. Thus, absent the small DCR lot, there would be no way people for whom the MBTA Red Line does not provide convenient access or who wish to launch a canoe or kayak to enjoy this area of the Reservation.



Master Plan Special Permit Criteria for Amendments to Master Plan

Bulfinch is seeking a minor amendment to the Cambridge Discovery Park Master Plan Special Permit, to join Buildings 400 and 500 at the third, fourth, and fifth stories, and to slightly modify the footprints of those buildings.

This request is similar in scope to Minor Amendment No. 2, which the Planning Board approved in October 2009. That amendment allowed Bulfinch to decouple proposed Building 200 from Building 100 (which had been constructed in 2004 for the Smithsonian Astrophysical Observatory) and decouple proposed Buildings 300 and 400; moving proposed Buildings 200 and 300 toward each other to create Building 200/300 as the new Cambridge home of Forrester Research.

This request also is similar in scope to Minor Amendment No. 4, which the Planning Board approved in October 2015. That amendment allowed Bulfinch to decouple proposed Building 500 from Building 600 (which now is under construction as a hotel) and shift Building 500 southward to the corner of Acorn Park Drive.

As described in Bulfinch's original application for the Cambridge Discovery Park Master Plan Special Permit:

The evolving Master Plan for Cambridge Discovery Park envisions that as many as six new occupied buildings will be built, most likely grouped in pairs, separated by access drives between Acorn Park Drive to the south and an internal circulation roadway between the new buildings and the two new parking garages to the north. Starting at the west, Building 100 will be constructed first, for the Smithsonian. ... This proposed layout and sequence may change over time, depending on future tenant needs. For example, if a future tenant were to require a larger, single-occupant building, such a building might be constructed in the area where Buildings 300 and 400 currently are envisioned. If such a tenant were to materialize in the near future, such a building could precede the construction of Building 200.

Application, page 20. The Planning Board's special permit decision expressly recognized that the master plan would evolve over time in response to future tenant demands:

This Decision approves the Master Plan with general size, massing, and locations of buildings and uses established at a conceptual level as described in the application documents. As a prerequisite to the issuance of a Building Permit, each new building shall be subject to design review by the Planning Board to determine conformance with the Design Guidelines, attached as Appendix II to this Decision, and the conditions of this permit.

Cambridge Discovery Park Master Plan Special Permit, Condition No. 2 (emphasis added). To that end, the special permit incorporates the Zoning Ordinance's PUD amendment process for future changes to the Master Plan:



Changes to the master Plan that do not constitute a substantial deviation from the overall project concept approved in this Decision, as determined by the Planning Board with guidance from Section 12.37 of the Zoning Ordinance, may be allowed as a Minor Amendment to this Decision at a regularly scheduled Planning Board meeting, upon an affirmative vote of five members of the [Planning] Board; unless otherwise indicated in this Decision, all other changes shall be considered a Major Amendment to this Special Permit, subject to the requirements of Section 10.40 for the issuance of a new special permit.

Cambridge Discovery Park Master Plan Special Permit, Condition No. 11. The referenced Section 12.37.2 of the Zoning Ordinance defines minor amendments:

Minor amendments are changes which do not alter the concept of the [Special Permit Master Plan] in terms of density, floor area ratio, land usage, height, provision of open space, or the physical relationship of elements of the development. Minor amendments shall include, but not be limited to, small changes in the location of buildings, open space, or parking; or realignment of minor streets.

As discussed below, this project does not alter the Cambridge Discovery Park Master Plan concept with respect to any criteria identified in Special Permit PB#198 or in the language of Section 12.37.2 of the Zoning Ordinance incorporated by reference into that decision.

The Building 400-500 changes are below the Minor Amendment thresholds

The Building 400-500 changes do not alter the concept of the Master Plan in terms of density. The combined building will have more total gross floor area than the two separate buildings would have. However, the density limits allowed under the Cambridge Discovery Park Master Plan will remain unchanged, *i.e.*, up to 819,916 square feet of gross floor area and 390,000 square feet of parking garages on the North Parcel (between north and west of Acorn Park Drive). Connecting Building 400 and 500 will result in a total gross floor area of approximately 278,000 square feet, as compared to approximately 229,000 square feet for separate Buildings 400 and 500. The total gross floor area for Cambridge Discovery Park will be 723,248, still below the 819,916 square feet authorized by the Master Plan Special Permit.

The Building 400-500 changes will not alter the concept of the Master Plan in terms of floor area ratio (“FAR”). Section 17.42.11 of the Zoning Ordinance provides that, “There shall be no maximum FAR limit on any lot within the Special District 4.” Connecting Buildings 400 and 500 will add approximately 49,000 square feet of gross floor area, resulting in an overall FAR (excluding structured parking) of 0.73.⁶ Thus, this amendment will comply with the overall FAR limit and fulfill the objectives of the Master Plan.

⁶ The Master Plan Special Permit dimensional table sets the maximum FAR (excluding structured parking) for the overall master plan at 0.71. That calculation included the restored Little River Area, resulting in a lot area of ~1,154,810 square feet. Using this larger lot area, the FAR including Building 400-500 is 0.626.

Connecting Buildings 400 and 500 will not alter the concept of the Master Plan in terms of land usage. The Master Plan envisioned a redeveloped campus with office, research and development, and life sciences as the principal tenant uses, augmented by accessory uses such as a cafe, day care facilities, and a health club. The principal uses of Building 400-500 will be office and research uses. Depending on tenant demand, accessory uses may include shared amenities such as a cafeteria or other supporting uses consistent with the Master Plan.

Connecting Buildings 400 and 500 will not alter the concept of the Master Plan in terms of building height. The Master Plan Special Permit authorizes an increased building height of eighty-five (85) feet for buildings other than parking garages, as provided for in Section 17.42.3 of the Zoning Ordinance.⁷ The Special Permit clarifies that “the final height of buildings, consistent with applicable provisions of the Zoning Ordinance, will be measured from final grades that will be altered and raised by the use of fill in order to ensure that the first occupied floor of future buildings will be above the established 100-year flood elevation.” Cambridge Discovery Park Master Plan Special Permit, page 18. As with Buildings 100, 200/300, and 600, the first floor elevation of Building 400-500 will be set at 10.8. Most of Building 400-500’s perimeter will feature building base planters and graded landscaping like those of Buildings 100, 200/300, and 600. The entrances to Building 400-500 facing Discovery Way (east side of Building 400, west side of Building 500) will be at grade, with the stairs and ramps between grade level and elevation 10.8 brought inside the building. This will allow the area beneath the connecting bridge to be more open, with improved sight lines. Consequently, Building 400-500’s base elevation for building height measurement will be less than 10.8. The height of Building 400-500 will not exceed eighty-five (85) feet, as measured under the Zoning Ordinance, consistent with the Master Plan.

The Building 400-500 changes will not alter the concept of the Master Plan in terms of the provision of open space. The Cambridge Discovery Park Master Plan calls for the former ADL Buildings in the Little River Area to be removed, and for that area to be restored to natural conditions. That process was completed several years ago. The master plan also calls for the former parking lot on the adjacent MDC Lot to be removed and that area restored to natural conditions. This was completed in conjunction with the construction of Building 100, years ahead of schedule. North and west of Acorn Park Drive, open space will be provided in approximately the same amount as shown on the 2004 Conceptual Illustration Scenario, as modified by Minor Amendments Nos. 2 and 4.

The Building 400-500 changes will not alter the concept of the Master Plan in terms of the physical relationship of elements of the development. The Cambridge Discovery Park Master Plan Special Permit established a three-phase process for the replacement over time of all of the former ADL buildings and surface parking lots on the North Parcel with as many as six new buildings with heights of up to 85 feet, and two parking garages, all served by a new, internal roadway, with all development kept away from the Little River. The master plan calls for “a much more dynamic interaction between the built and unbuilt environment than is typical elsewhere in the City [in that] the District will present an urban

⁷ Within the Parkway Overlay District, lower building heights apply as specified in Section 20.64.2. Building 400-500 will not extend into the Parkway Overlay District.

edge against a natural environment, a sharper contrast than appears elsewhere in the City and one that should be appropriately and creatively treated and celebrated.” Cambridge Discovery Park Special Permit, page 35 (Design Guidelines). Building 200/300 maintained the urban edge along the north side of Acorn Park Drive, with its dynamic interaction between the North Parcel and the Little River Area. Building 400-500 will continue this urban edge eastward to and around the corner of Acorn Park Drive. The original master plan envisioned three pairs of buildings. With the connection of Buildings 400 and 500, Cambridge Discovery Park will have two pairs of buildings at its center—Building 200/300 and Building 400/500, with solo buildings at the western and northern edges of the developed area. The Cambridge Discovery Park Master Plan Special Permit anticipated that the number and location of connections between the new, internal roadway and Acorn Park Drive might differ from what was shown on the 2004 Conceptual Illustration Scenario, with Condition No. 1(iv) providing that there must be “at least two, but not more than four,” such connections. The Building 200/300 Project shifted the westerly roadway connection from between Buildings 200 and 300 to between Buildings 100 and 200 to accommodate Forrester’s needs; the overall number of connections remained at three. The Building 400-500 changes will not modify the new internal roadway location established by Minor Amendments Nos. 2 and 4.

The Building 400-500 changes are allowed by minor amendment

As noted above, Section 12.37.2 of the Zoning Ordinance, incorporated by reference into the Cambridge Discovery Park Master Plan Special Permit provides that, “Minor amendments shall include, but not be limited to, small changes in the location of buildings, open space, or parking; or realignment of minor streets.” The Building 400-500 changes will connect the third, fourth, and fifth stories of Building 500 (previously decoupled from conceptual Building 600) to Building 400 (previously decoupled from conceptual Building 300). The changes to the currently-approved footprints of Buildings 400 and 500 will be minor. These changes are being made to avoid creating a monolithic facade facing the restored Little River Area and to visually open the area beneath the connecting upper story “bridge.” These adjustments will approve the connected building’s participation in the planned urban edge extending nearly 1,400 feet along the north side of Acorn Park Drive. There will be no changes to the internal roadway or to the approximately eight acres of new open space created in the Little River area and on the former MDC Lot.

The Special District 4 zoning and the Cambridge Discovery Park Master Plan Special Permit envisioned that the approximately 4.22-acre MDC Lot and the approximately 3.76-acre Little River Area would be restored to natural conditions during a later stage of the redevelopment of Cambridge Discovery Park. Today, all of this restoration work has been completed; the amount of open space created in these areas will not be changed.

The Building 400-500 changes will not alter the Cambridge Discovery Park Master Plan Special Permit’s final parking configuration. As previously approved, almost all of the historic 1,052 surface parking spaces still will be relocated into Garage A and Garage B.

For all the reasons set forth above, the Building 400-500 changes do not exceed any of the limitations on minor amendments to the Cambridge Discovery Park Master Plan.



The Building 400-500 changes do not require a major amendment to the master plan

The Building 400-500 changes clearly are not a major amendment to the Master Plan. Section 12.37.3 of the Zoning Ordinance defines major amendments as:

“Major amendments represent substantial deviations from the [Special Permit Master Plan] concept approved by the Planning Board. Major amendments shall include, but not be limited to, large changes in floor space, mix of uses, density, lot coverage, height, setbacks, lot sizes, open space; changes in the location of buildings, open space, or parking; or changes in the circulation system.”

As discussed above, the Building 400-500 changes will not involve any changes to the overall floor space, mix of uses, density, height, lot sizes, or open space.

The Building 400-500 changes will not result in large changes in lot coverage. The 2004 conceptual Master Plan anticipated that, at full buildout, approximately 10 acres of the 26.5 acre property would be covered with up to 819,916 square feet of gross floor area in new buildings, two parking garages, access drives, sidewalks, landscaping, and related improvements, with the majority (approximately 16.5 acres) of the property as open space (and the adjacent 4.22-acre MDC Lot restored to open space). The Building 400-500 changes are consistent with these lot coverage goals.

The Building 400-500 changes will not result in large changes in setbacks. Condition 1(iii) of the Master Plan requires a minimum front yard setback of at least forty (40) feet from the centerline of Acorn Park Drive. The east and south sides of Buildings 400-500 will be set back at least 40 feet from the centerline of Acorn Park Drive.

The Building 400-500 changes will not result in large changes to the locations of buildings. Buildings 400 and 500 will remain generally as approved by Minor Amendment No. 4. The minor changes to the footprints will facilitate a more interesting facade facing the restored Little River Area and more open area beneath the upper story connection.

The Building 400-500 changes will not result in large changes in parking. There will be no change to the locations of parking at full buildout. All of the 1,052 former surface parking spaces will be eliminated and almost all of them will be relocated to within Garages A and B, with a few short-term surface parking spaces within the campus's interior for passenger drop-off, deliveries, and related transient uses.

The Building 400-500 changes will not result in large changes in the circulation system. Discovery Way, the internal roadway will continue to function as revised by Minor Amendment No. 4, starting west of Building 100, arcing behind Building 200/300, before reconnecting to Acorn Park Drive between the connected Buildings 400 and 500.

For all of these reasons, the Building 400-500 changes **do not** constitute a Major Amendment to the Master Plan.

Design Review of Buildings 400-500

Condition 2 of the Cambridge Discovery Park Master Plan Special Permit establishes the design review process for future buildings.⁸ It states that in granting that Master Plan Special Permit, the Planning Board

approves the Master Plan with general size, massing, and locations of buildings and uses established at a conceptual level as described in the application documents. As a prerequisite to the issuance of a building permit, each new building shall be subject to design review by the Planning Board to determine conformance to the Design Guidelines, attached as Appendix II to this decision, and the conditions of this permit.

...

Design approval shall be granted by the Planning Board for development consistent with the Design Guidelines, the conditions of this Decision, and the applicable requirements of the Zoning Ordinance.

Compliance with the Cambridge Discovery Park Master Plan Special Permit Design Guidelines

The Cambridge Discovery Park Master Plan Design Guidelines recognize that Special District 4 is unlike any other area of the City. The area's proximity to the Alewife Reservation and the historical pattern of development adjacent to the Little River present unique challenges, and require particular solutions.

The transformation of the former ADL campus into Cambridge Discovery Park is reclaiming an urban wild. In doing so, Cambridge Discovery Park presents a much more dynamic interaction between the built and unbuilt environments than is typical elsewhere in the City. This urban edge should be celebrated, and treated appropriately and creatively.

The susceptibility of the site to flooding, from upstream stormwater flows and from back flows caused by downstream obstructions, requires compensatory flood storage capacity. The requirement that first floor elevations of all occupied buildings must be kept above FEMA's calculated 100-year flood elevation presents additional design challenges and opportunities.

The Cambridge Discovery Park Master Plan Design Guidelines provide a framework within which these issues can be addressed in an aesthetically and functionally-appropriate manner that responds to Special District 4's unique characteristics. The Guidelines' criteria are discussed below with respect to Building 400-500.

⁸ Condition 3 of the Cambridge Discovery Park Master Plan Special Permit approved the design of Building 100 and Garage A, and associated site improvements.

Building 400-500 Design Details

a. Open space and circulation design

1. Open Space

The creation and restoration of open space areas has occurred much faster than required by the Special District 4 zoning. The adjacent DCR land is fully restored to natural conditions, several years ahead of schedule. The Special District 4 zoning requires that the demolition of buildings in the Little River Area must begin when the total gross floor area (excluding parking garages) exceeds 660,000 square feet, and must be completed before the total gross floor area (excluding parking) exceeds 850,000 square feet. Today, although the redeveloped campus's gross floor area (excluding parking) is only approximately 445,248 square feet⁹, all of Arthur D. Little Company's former buildings have been removed from the Little River Area. The Special District 4 zoning requires that fifty percent of the Little River Area must be restored to urban wild natural conditions when the total gross floor area (excluding parking) exceeds 660,000 square feet. That restoration was fully completed in conjunction with construction of Building 200/300 for Forrester Research, well in advance of the Special District 4 zoning timeline.

The Design Guidelines call for private development bordering public open space and public thoroughfares to have direct access to the public space, and to present inviting elevations and imagery. The principal entrances to Building 400-500 will face onto Discovery Way, the internal roadway looping from Acorn Park Drive through the campus. From these entrances, tenants and visitors will be able to look northward to the campus's landscaped interior or south toward the restored Little River Area. The Building 500 portion also will have an entrance in the southeast corner, leading to an exterior dining terrace, with a stair and a ramp connecting the terrace to the sidewalk along Acorn Park Drive. From the terrace, tenants and visitors will have expansive views eastward to the restored MDC land and southward to the restored Little River Area.

2. Transit Shuttle

The Design Guidelines call for efforts to increase the usage of the nearby Alewife MBTA station, including the provision of a shuttle between Cambridge Discovery Park and the station. Paul Revere Transportation operates a shuttle bus between 7:15 a.m. and 9:30 a.m. and between 4:15 p.m. and 8:00 p.m. on weekdays, *i.e.*, during peak periods. The shuttle circulates between Cambridge Discovery Park and the Alewife station. Tenants of Building 400-500 will be able to use the shuttle bus.

3. Pedestrian and Bicycle Circulation

In 2004, Bulfinch constructed a multi-use pedestrian and bicycle connection between Cambridge Discovery Park and the Alewife MBTA station. The Building 200/300 project shifted the lateral connection between Acorn Park Drive and the internal roadway, to

⁹ This includes approximately 5,600 square feet of gross floor area allocated to the Giant Magellan Telescope Annex to Building 100, which has not yet been (and may never be) constructed.

between Buildings 100 and 200, and consolidated the loading areas for Buildings 200/300. This eliminated multiple conflicts among pedestrian/bicycle/vehicle/loading uses from the master plan's interior courtyard area.

The pedestrian / bicycle pathway across the adjacent, restored former DCR parking lot provides convenient pedestrian and bicycle access between Cambridge Discovery Park and the Alewife station. Sixty-six bicycle parking spaces currently are available on the campus, of which 46 are long-term spaces. Building 400-500 will be provided with an additional 61 long-term bicycle spaces, to be located inside Garage B, and 17 short-term bicycle spaces, located near the primary entrances.

4. Parking and Service Facilities

Bulfinch anticipates constructing Garage B in conjunction with the construction of Building 400-500. As discussed below, Building 400-500 may be built in two phases, in which case Garage B could be built in conjunction with either phase depending on tenant uses and parking demand. Eventually, all parking for tenants of and visitors to Building 400-500 will be provided in Garage B. Building 400-500's loading bays will be in the building's northerly side.

b. Land use

1. Uses

The principal use of Building 400-500 is expected to be general office or research; both uses are allowed by right under the Zoning Ordinance and the Cambridge Master Plan Special Permit, and are anticipated by the Design Guidelines.

2. Parking

The 454 surface parking spaces formerly located on the adjacent MDC Lot have been eliminated. Garage A provides approximately 652 structured parking spaces for Cambridge Discovery Park tenants and their visitors. Garage B, to be constructed in conjunction with Building 400-500, will provide 368 additional structured parking spaces. The remainder of the 1,052 parking spaces allowed by right at Cambridge Discovery Park will be provided as short-term surface parking spaces for passenger drop-off, deliveries, and related transient uses.

c. Elements of form

1. Height

The Design Guidelines acknowledge that the redevelopment of Cambridge Discovery Park generally requires a full height build-out of eighty-five feet. Building 400-500 will have a height of eighty-five feet.¹⁰ As anticipated by the Design Guidelines, sloped areas and raised

¹⁰ As provided for in Section 5.23 of the Zoning Ordinance, this height measurement does not include chimneys, water towers, air conditioning equipment, elevator bulkheads, skylights, ventilators, and other necessary features appurtenant to buildings which are usually carried above roofs and not used for human

planters will be used to establish the first floor elevation of Building 400-500 above the 100-year flood plain. Most of the perimeter of Building 400-500 will feature building base planters and graded landscaping like those of Buildings 100, 200/300, and 600. The entrances to Building 400-500 facing Discovery Way (east side of Building 400, west side of Building 500) will be at grade, with the stairs and ramps between grade level and elevation 10.8 brought inside the building. This will allow the area beneath the connecting bridge to be more open, with improved sight lines. Consequently, unlike the other occupied buildings, the base elevation of Building 400-500 will be less than 10.8. The height of Building 400-500 will not exceed eighty-five (85) feet, as measured under the Zoning Ordinance, consistent with the Master Plan.

Pedestrian View at Passage



March 11, 2016

The Bulfinch Companies, Inc.

PTA
PAUL TRONER ARCHITECTS

Stantec

View of passage through Building 400-500 showing at-grade entrances

2. Scale

Building 400-500 will relate to human dimensions and to provide a sense of intimacy along the bordering public way and internal campus open space. The building will be clad in a combination of aluminum and glass curtain wall, metal panel, wood and glass curtain wall, and precast architectural concrete. The precast facade elements used for Building 400-500 will differ from those used for Buildings 100, 200/300, and 600, but are derived from the same family. The ground floors of the Acorn Park Drive facing sides of Building 400-500 will be highly transparent, inviting occupants to look out toward the urban wilds, and providing animated interior views to pedestrians. The connecting “bridge” at the third, fourth, and fifth floors also will be highly transparent, for the same reasons.

occupancy. Any such elements have been designed in a coordinated, distinctive manner in concert with the upper floors of the building.

3. Massing

The precast elements of Building 400-500 will integrate the new building with Building 300 to the west, creating the feel of an urban campus, while preserving each building's distinct identity. Significant portions of the facades of the lower two floors of Building 100 are solid, due to the Smithsonian's particular needs (development and testing of telescope systems). By contrast, the facades on all floors of Building 200/300 feature large windows, bringing daylight into the occupied spaces, providing views of the adjacent public open spaces and urban wilds, and softening shadows. Building 400-500 will continue aesthetic glazing on all facades.

Notches at corners of Building 400-500's ground floor, articulation of the building's facades, and a narrowing of the upper level connection will articulate the major wall planes, reducing the building's perceived mass. In keeping with the Design Guidelines, Building 400-500 will have a distinctive character, but has been designed in an architecturally compatible manner as the next step in the family of buildings that make up an integrated urban campus.

4. Setbacks

Section 17.42.2 of the Zoning Ordinance authorizes the Planning Board to waive all yard requirements in Special District 4 other than the front yard requirement in the Parkway Overlay District. Condition 1(iii) of the Cambridge Discovery Park Master Plan Special Permit established the forty foot setback from the centerline of Acorn Park Drive, and certain setbacks for Garage A and Garage B, and provides for the setbacks of future buildings to be approved during the design review process. Building 400-500 will be set back at least forty feet from the centerline of Acorn Park Drive, as required by the Design Guidelines.

5. Street Wall Patterning/Base, Middle and Top

The Design Guidelines call for buildings to have a tripartite architectural configuration of base, middle, and expressive top. The approved designs for Buildings 400 and 500 have distinct ground floors, middle floors, and top floors. Rather than reading as a stack of plates, however, the base, middle, and top layers interact with each other with selected cladding materials crossing layer boundaries. The contours and exterior materials of Buildings 400 and 500 were designed to modulate each building's massing both vertically and horizontally. The pre-cast facades transition to lighter materials (metal panel) as they wrap to the Discovery Way side, emphasizing the difference in character between the restored urban wild to the south and the redesigned internal courtyard to the north. These themes are retained in the revised Building 400-500 facades. Additional physical and visual articulation has been added to prevent the connected building's long sides from reading as monolithic.

View from Alewife Reservation



March 11, 2016

The Bulfinch Companies, Inc.

pfa
PFAV, PFAV, PFAV

Stantec

View of Building 400-500 from Alewife Reservation

Vertically, the building mass will be divided into the recommended tripartite configuration, with a strong base, middle, and top reading. The base is primarily pre-cast and glass. In some areas, the plane of the base facade is stepped back into the building, to provide shade for active interior uses and to extend the exterior terraces into the occupied first floor areas. The westerly (Building 400) portion has been designed to respond the existing context established by Buildings 100 and 200/300, while continuing the precedent of design that speaks to the innovation that will take place at Cambridge Discovery Park. The easterly (Building 500) portion facing Acorn Park Drive has a much more transparent facade, to provide building occupants with vistas of the restored MDC parking lot, the Little River Area, the Little River, and other MDC reservation lands. The northern portion of the building's easterly facade will be clad in brown architectural precast, acknowledging the adjacent Building 600 hotel.

Approach from Alewife T



March 11, 2016

The Bulfinch Companies, Inc.

pfa
PFA VISION ENGINEERING

Stantec

View of approach to Building 400-500 from the Alewife MBTA station

Rooftop mechanical equipment will be fully screened, as was done on Buildings 100 and 200/300. The screening also will be articulated, reaching the building face in some areas and set back in others, to provide a varied skyline.

6. Silhouette

The Design Guidelines call for buildings to provide animated, varied silhouettes that create an appropriate identity and enrich views from the Alewife Reservation, nearby areas, and public ways. Building 400-500 will differ in form from Buildings 100, 200/300, and 600. Consequently, it will present a different silhouette to Acorn Park Drive. This silhouette will be animated by the top floor setbacks, and varied planes of the street walls (along Acorn Park Drive and along the internal roadway), and by the further articulation of the central core areas. Viewed from the north or south, the building's silhouette also will be broken by the opening where Discovery Way passes through the building.

7. Color

As recommended by the Design Guidelines, the precast elements, landscaping planters, stone walls, and other elements of the Building 400-500 Project will use warm and inviting colors that complement the Alewife Reservation's natural range.



Warm Palette of Natural Materials Used in Landscaping

8. Architectural Details

As recommended by the Design Guidelines, Building 400-500 will be faced with an ordered combination of appropriate materials, including precast concrete, wood, stone, and glass. The ground floor walls will maximize visibility and transparency through the use of large areas of glass. All mechanical penthouse areas will be set back from the principal building facade. Those areas will be architecturally screened and integrated within the overall building form and individual elevations.

The signage for Building 400-500 will be consistent with that used for Buildings 100, 200/300, and 600.

Interior lighting will use timers or occupancy sensors to ensure that non-safety lighting is turned off when not needed.

9. Landscape Architectural Details

Acorn Park Drive's handsome, tree-lined appearance has been strengthened by the addition of new oak trees along the north side and additional plantings along the south side. Landscaping plantings for Building 400-500 will be drought tolerant, native species that do not require regular pruning or maintenance. Plantings near or beneath the upper story

connection will be shade-tolerant. The vocabulary of stone-faced landscaping planters, low stone walls topped with seating, stone steps, and new, wider sidewalks with street trees that began with Building 100 and continued with Building 200/300 will be extended farther along Acorn Park Drive adjacent to Building 400-500.

Pedestrian View at Passage



March 11, 2016

The Bulfinch Companies, Inc.

pia
PARK INTERIORS ARCHITECTURE

Stantec

Pedestrian view at passage showing variety of plantings and hardscape

Compliance with other Master Plan Special Permit conditions

a. Preliminary submission of building design

Condition 2(ii) of the Cambridge Discovery Park Master Plan Special Permit encourages Bulfinch to present the design of any building, including any “green” building features to the Planning Board at an early schematic stage to permit adequate opportunity to refine and modify the design. Here, Building 400-500 is a further refinement of the individual Buildings 400 and 500 previously approved by the Planning Board through Minor Amendment No. 4 and the accompanying design review decisions. Bulfinch remains committed to redeveloping Cambridge Discovery Park in an environmentally-friendly, energy-conscious manner. To that end, Bulfinch is committed to constructing Building 400-500 to meet at least the requirements of LEED Silver certification. Whether LEED Gold or Platinum can be achieved will depend on the tenant(s) selected for the building.

b. Interior courtyard concerns

Condition 2(iii) of the Cambridge Discovery Park Master Plan Special Permit requires that future building proposals must address the Planning Board’s concerns, as set out in the special permit’s findings, that the Master Plan’s interior courtyard space was too heavily dominated by vehicular circulation and delivery functions, poorly defined as an urban space, and inadequate to the needs of pedestrians and bicyclists. In granting the Cambridge Discovery Park Master Plan Special Permit, the Planning Board had found that:

[T]he circulation within the interior courtyard space in the Master Plan (i.e. that entire irregular area contained by and located behind all of the buildings and parking garages that constitute the Master Plan) through which pedestrians and bicyclists will be passing, along with automobiles going to the various parking facilities and trucks heading to the several loading bays, is not resolved in a satisfactory way. The areas paved exclusively for vehicular traffic are too extensive and the green areas devoted to landscaping and pedestrian circulation too amorphous and “residual” in feeling rather than convincing the observer that they are consciously designed. The geometry of the spaces appears cluttered and awkward. More attention needs to be paid to the design of this space with consideration given to reducing the area devoted to vehicular paving, possible consolidation of loading facilities, design of more dual-use pedestrian/vehicle areas, etc.

Cambridge Discovery Park Master Plan Special Permit, page 11. Condition 2(iii) of the Cambridge Discovery Park Master Plan Special Permit requires that:

In each instance that a building is presented to the Planning Board, after Building 100, the Permittee shall address the Board’s concern, as set forth in the Findings above, that the interior courtyard space in the Master Plan, as illustrated in the application documents, is too heavily dominated by vehicular circulation and delivery functions, poorly defined urban space, and inadequate to the needs of pedestrians and bicyclists who will be traversing it.

The conceptual Master Plan envisioned an internal roadway loop with three connections to Acorn Park Drive. The initial segment of this internal roadway was built in connection with the Building 100 project. This segment starts just west of Building 100 and arcs behind Building 100, between the potential future Giant Magellan Telescope Annex site and Garage A. Originally, this roadway was to have continued eastward, with future Building 300/400 on its south side and Garage B and Building 500/600 to its north. Between future Buildings 200 and 300, the conceptual Master Plan showed a lateral roadway, connecting Acorn Park Drive to the internal roadway, to the east of Garage A. All of the proposed future buildings were to have loading dock access directly off this internal roadway. The Planning Board felt that this interior roadway layout and the associated vehicular circulation patterns warranted further thought.

Minor Amendment No. 2, for the Forrester Research Building 200/300 project, addressed these concerns in several ways. First, much of the conceptual Master Plan's interior courtyard conflict among passenger vehicles, pedestrians, bicyclists, and delivery vehicles arose from the intersection of the lateral connection from Acorn Park Drive to the internal roadway formerly proposed between future Buildings 200 and 300. Loading access for these buildings was to have been provided just west and east of this intersection. Garage A's entrance/exit drive would have intersected the internal roadway approximately opposite this location. Drivers going to or from Acorn Park Drive via the lateral connection would have perceived theirs as the primary travel path. Drivers traveling west along the internal roadway also would have perceived theirs as the primary travel path. This would have created conflicts at the intersection when drivers from several directions all perceived that they should have the right of way. The pedestrians experience in this area would have been interrupted by a series of street and loading bay access crossings in close proximity. Quite simply, too much would have been going on in too small a space.

Minor Amendment No. 2 detached conceptual Building 200 from Building 100 and moved it to the east, to join conceptual Building 300, which was shifted to the west. The lateral connection formerly shown between Buildings 200 and 300 now is located between Buildings 100 and 200. Staggering the two side intersections of lateral connections with the internal roadway eliminated the crossing conflict at Garage A. Loading bays for Buildings 200/300 are in the northeast corner of the building, away from the lateral connection. Pedestrians traveling between Building 100 and Garage A now cross the internal roadway west of the garage driveway. Pedestrians traveling between Building 200/300 and Garage A also cross the internal roadway west of the garage driveway, to a large landscaped area, and then cross the single-lane access to the drop-off area.

The conceptual master plan did not include any passenger drop-off areas for the proposed buildings. The revised master plan includes a drop-off area serving Building 200/300. Major Amendment No. 3 allowed Building 600 to be constructed as a hotel. The hotel's separate, dedicated drop-off area and a small, short-term surface parking area for guests arriving at and departing from the hotel further improved and separated the pedestrian and vehicular access paths through the interior courtyard area.

c. Pedestrian access to Belmont

Condition 2(iii) of the Cambridge Discovery Park Master Plan Special Permit also requires Bulfinch to report to the Planning Board on a periodic basis on “the opportunities for the provision of pedestrian access from Belmont to the site, either along Acorn Park Drive or via the Concord Turnpike, preferably in cooperation with abutting and similarly impacted property owners.”

Bulfinch has granted to Criterion Development Partners, the developer of the adjacent 227-unit VOX on Two project (formerly known as the Residences at Alewife), an easement for pedestrian access from their property over a portion of Cambridge Discovery Park to Acorn Park Drive. This provides a safer, more pleasant pedestrian connection between VOX on Two and the Alewife Red Line station. Absent this easement, residents and guests of that project would need to use the sidewalks along the south side of the Concord Turnpike and the Alewife exit ramp.

Bulfinch has discussed with O’Neill Properties, the owner of the adjacent Belmont land, the possibility of providing sidewalks along the Belmont portion of Acorn Park Drive. While Acorn Park Drive is a public way in Cambridge, it becomes a private way at the Belmont line. The existing pavement is adequate for two-way vehicular travel, but adding a sidewalk on either side would require the cutting of numerous trees, and would involve work within land subject to flooding, bordering vegetated wetlands, and other resource areas protected under the Wetlands Protection Act. Recently, O’Neill Properties has expressed interest in providing pedestrian access from its property along Acorn Park Drive to the public sidewalks in Cambridge. Bulfinch and O’Neill Properties are discussing the easement, maintenance, and permitting implications of constructing this connection.

d. Efficient use of natural and energy resources

Condition 2(v) of the Cambridge Discovery Park Master Plan Special Permit requires that:

Each time a building is initially presented to the Planning Board for design review, the Permittee shall summarize how construction in the Park to date has employed natural and energy resources efficiently in the construction, maintenance and long-term operation of buildings already constructed and report on how such efforts will be employed in the building currently under consideration. Reference to LEED or other equivalent standards is encouraged.

Building 100 was designed to meet the criteria for LEED Silver certification, although Bulfinch did not elect to go through the certification process. Measures undertaken to meet these criteria included:

- Site location near MBTA station and Minuteman mixed-use path;
- Water efficient landscaping;
- Water use reduction for building fixtures, *e.g.*, low-flow toilets and sinks;

- External sunshades built into design to reduce solar gain and cooling load;
- Building orientation to maximize south-facing glazing;
- Optimized energy performance;
- Construction waste management;
- Thermal comfort systems for building occupants;
- Daylight and views for 75% of occupied spaces; and
- On-site treatment of stormwater through the use of bioswales and detention ponds.

Forrester Research's Building 200/300 was certified as LEED Gold (Core and Shell) in June 2012 and LEED Platinum (Commercial Interiors) in August 2012. Measures undertaken to achieve these ratings included:

- Site location near MBTA station and Minuteman mixed-use path;
- Water efficient landscaping and no use of potable water for irrigation;
- 40% reduction in water use for building fixtures through the use of low volume toilets and urinals and low-flow faucets;
- Selection of refrigerants and HVAC refrigeration that minimize the emission of ozone-depleting compounds;
- Optimizing energy performance of lighting, HVAC, and tenant equipment and appliances to reduce energy consumption;
- Construction waste management (at least 75% of construction debris diverted from landfills through recycling or reuse);
- Use of building materials with recycled content or that have been extracted, harvested or recovered, as well as manufactured, locally;
- Certified wood;
- Use of low VOC-emitting adhesives, sealants, paints and coatings, flooring systems, furniture, and other building components;
- Thermal comfort systems for building occupants;
- Daylight and views for 75% of occupied spaces; and
- On-site treatment of stormwater through the use of bioswales and detention ponds.

Building 400-500 will incorporate a variety of environmental and energy-conservation measures, including:

- Site location near MBTA station and Minuteman mixed-use path;
- Water efficient landscaping and no use of potable water for irrigation;



- Reduction in water use for building fixtures through the use of low volume toilets and urinals;
- Selection of refrigerants and HVAC refrigeration that minimize the emission of ozone-depleting compounds;
- Optimizing energy performance of lighting, HVAC, and tenant equipment and appliances to reduce energy consumption;
- Construction waste management (at least 75% of construction debris diverted from landfills through recycling or reuse);
- Use of building materials with recycled content or that have been extracted, harvested or recovered, as well as manufactured, locally;
- Use of low VOC-emitting adhesives, sealants, paints and coatings, flooring systems, furniture, and other building components;
- Thermal comfort systems for building occupants;
- Daylight and views for 75% of occupied spaces; and
- On-site treatment of stormwater through the use of bioswales and detention ponds.

Finalization of the full portfolio of environmental and energy-conservation measures to be incorporated into Building 400-500 will occur after the tenant(s) has been selected. Several members of the architectural/design team are LEED Accredited Professionals, including the permitting attorney.

e. City Noise Ordinance

Condition 12 of the Cambridge Discovery Park Master Plan Special Permit requires that all authorized development must conform to the requirements of the City of Cambridge Noise Control Ordinance, Chapter 8.16 of the Cambridge Municipal Code. Chapter 8.16 establishes maximum noise levels during the daytime and at other times, as measured from lot lines. Building 400-500 will comply with these limits.

Possible Phased Construction of Building 400-500

Bulfinch is seeking Planning Board approval to potentially construct Building 400-500 in two phases. Bulfinch hopes to attract a single, large tenant that will occupy most or all of Building 400-500. If this happens, Bulfinch will construct Building 400-500 as a single project. Given market uncertainties, however, Bulfinch may end up needing to find a group of tenants to occupy Building 400-500. If that happens, Bulfinch proposes to construct one of the building elements first, for the initial tenant(s), and to construct the connector and second building element for a later tenant(s). Whether the Building 400 element or the Building 500 element would be built first will depend on tenant demand.

Depending on the use(s) of the initial tenant(s), Garage A and the existing surface spaces may provide sufficient parking for an initial phase of construction. In that case, Bulfinch would continue to postpone construction of Garage B until the second phase of construction for Building 400-500.

If Building 400-500 is constructed in two phases, the building facade area where the upper story bridge will later connect will be clad with the same aluminum and glass curtain wall as the majority of the facade.



Image of eastern facade of stand-alone Building 400



Image of stand-alone Building 500

Dimensional Form – Building 400-500

Project Address: 20 & 40 Acorn Park Drive

Application Date: March 17, 2016

	Existing	Allowed or Required (max/min)	Proposed	Permitted
Lot Area (sq ft)	990,317 ^a	5,000	990,317 ^a	
Lot Width (ft)	>170	50	>170	
Total Gross Floor Area (sq ft)		819,916 ^b	278,000	
Residential Base				
Non-Residential Base				
Inclusionary Housing Bonus				
Total Floor Area Ratio		n/a ^c	0.28	
Residential Base		n/a		
Non-Residential Base		n/a		
Inclusionary Housing Bonus		n/a		
Total Dwelling Units	0		0	
Base Units			n/a	
Inclusionary Bonus Units			n/a	
Base Lot Area/Unit (sq ft)			n/a	
Total Lot Area/Unit (sq ft)			n/a	
Building Height (ft)		65/85 ft. ^d	85 ft.	
Front Yard Setback (ft)		40 ft. ^e	40 ft.	
Side Yard Setback (ft)		n/a ^f	variable	
Side Yard Setback (ft)		n/a ^f	variable	
Rear Yard Setback (ft)		n/a ^f	variable	
Open Space (% of lot area)		n/a		
Private Open Space		n/a		
Permeable Open Space		n/a		
Other Open Space (Specify)		n/a		
Off-Street Parking Spaces	706	1 per 1,050 sf of research lab ^g	265	
Long-Term Bicycle Parking		61 ^h	61	
Short-Term Bicycle Parking		22	22	
Loading Bays		2	2	

Notes to Dimensional Form – Building 400

- a Combined lot area of Cambridge Discovery Park parcels north and west of Acorn Park Drive.
- b The Special District 4 zoning allows up to 900,000 square feet of gross floor area, plus up to 400,000 square feet of structured parking. CZO § 17.42.11. The Cambridge Discovery Park Master Plan Special Permit authorizes up to 819,916 square feet of gross floor area, plus up to 390,000 square feet of structured parking.
- c No maximum floor area ratio for any lot in Special District 4, per CZO § 17.42.11.
- d The maximum by right building height in Special District 4 is 65 feet, which was increased to 85 feet for nonresidential uses by the Cambridge Discovery Park Master Plan Special Permit. *See* CZO, § 7.42.3.
- e Measured from centerline of Acorn Park Drive, per Condition 1(iii) of Cambridge Discovery Park Master Plan Special Permit.
- f CZO § 17.42.2 authorizes the Planning Board to waive minimum yard requirements by special permit, other than the front yard requirement within the Parkway Overlay District. Condition 1(iii) of the Cambridge Discovery Park Master Plan Special Permit waives all yard requirements, other than the front yard requirement within the Parkway Overlay District and a 40 front yard requirement (measured from the street centerline) along Acorn Park Drive.
- g For general office use, which requires 1 space per 800 sf of gross floor area, 348 parking spaces would be required. CZO § 17.43.1 provides that a maximum of 1,052 parking spaces is required for any combination of uses up to 900,000 square feet of gross floor area within Special District 4.
- h For general office use, 83 long-term bicycle spaces would be required.

Dimensional Form – Existing plus Building 400-500 and Garage B

Project Address: 20 & 40 and 30 Acorn Park Drive **Application Date:** March 17, 2014

	Existing	Allowed or Required (max/min)	Proposed	Permitted
Lot Area (sq ft)	990,317 ^a	5,000	990,317 ^a	
Lot Width (ft)	>170	50	>170	
Total Gross Floor Area (sq ft)	363,248	819,916 ^b	723,248 ^c	
Residential Base	0		82,000	
Non-Residential Base	363,248 ^c		641,248 ^c	
Inclusionary Housing Bonus	n/a		n/a	
Total Floor Area Ratio	0.45	n/a ^d	0.73	
Residential Base		n/a	0.083	
Non-Residential Base		n/a	0.648	
Inclusionary Housing Bonus		n/a	n/a	
Total Dwelling Units	0		0	
Base Units			n/a	
Inclusionary Bonus Units			n/a	
Base Lot Area/Unit (sq ft)			n/a	
Total Lot Area/Unit (sq ft)			n/a	
Building Height (ft)	85	65/85 ft. ^e	85 ft.	
Front Yard Setback (ft)		40 ft. ^f	40 ft.	
Side Yard Setback (ft)		n/a ^g	various	
Side Yard Setback (ft)		n/a ^g	various	
Rear Yard Setback (ft)		n/a ^g	various	
Open Space (% of lot area)		n/a		
Private Open Space		14,856 ^h	>15,000	
Permeable Open Space		n/a		
Other Open Space (Specify)		n/a		
Off-Street Parking Spaces	706	1,052 ⁱ	1,052	
Long-Term Bicycle Parking	50	101 ^j	≥115	
Short-Term Bicycle Parking	30	52	≥53	
Loading Bays	4	6	6	

Notes to Dimensional Form – Existing plus Building 400-500 and Garage B

- a Combined lot area of Cambridge Discovery Park parcels north and west of Acorn Park Drive.
- b The Special District 4 zoning allows up to 900,000 square feet of gross floor area, plus up to 400,000 square feet of structured parking. CZO § 17.42.11. The Cambridge Discovery Park Master Plan Special Permit authorizes up to 819,916 square feet of gross floor area, plus up to 390,000 square feet of structured parking.
- c This includes approximately 5,600 square feet of gross floor area of Building 100 for the Giant Magellan Telescope Annex, which has not yet been built.
- d No maximum floor area ratio for any lot in Special District 4, per CZO § 17.42.11.
- e The maximum by right building height in Special District 4 is 65 feet, which was increased to 85 feet for nonresidential uses by the Cambridge Discovery Park Master Plan Special Permit. *See* CZO, § 17.42.3.
- f Measured from centerline of Acorn Park Drive, per Condition 1(iii) of Cambridge Discovery Park Master Plan Special Permit.
- g CZO § 17.42.2 authorizes the Planning Board to waive minimum yard requirements by special permit, other than the front yard requirement within the Parkway Overlay District. Condition 1(iii) of the Cambridge Discovery Park Master Plan Special Permit waives all yard requirements, other than the front yard requirement within the Parkway Overlay District and a 40 front yard requirement (measured from the street centerline) along Acorn Park Drive.
- h CZO § 17.40 does not establish any open space ratio requirements for Special District 4, but does require that the Little River Area be restored to natural conditions, *i.e.*, returned to and maintained as open space area, and that the Large Wetland Area be left undisturbed, *i.e.*, be maintained as open space area. Except as provided in CZO § 17.40, all requirements and regulations applicable to the Office 2 districts apply to Special District 4. Table 5.2 requires 15% private open space for residential uses in Office 2 districts, including hotels. The Building 600 hotel private open space requirement was calculated as: $990,317 \text{ sf} * 0.15 * 82,000 \text{ (hotel gross floor area)} / 819,916 \text{ (total allowed gross floor area under Cambridge Discovery Park Master Plan Special Permit)} = 14,856 \text{ sf}$.
- i CZO § 17.43.1 provides that a maximum of 1,052 parking spaces is required for any combination of uses up to 900,000 square feet of gross floor area within Special District 4.
- j Assuming Building 400-500 is entirely devoted to research laboratory uses; if devoted to general office use, a total of 133 long-term spaces would be required.

**CDP Combined Building 400/500:
Minor Amendment Graphic Submission**

03/25/2016

Master Plan Special Permit PB # 198 Cambridge Discovery Park



- 
- 1. Review of Permitted Buildings 400 & 500**
 - 2. Proposed Revision**
 - 3. Discussion**

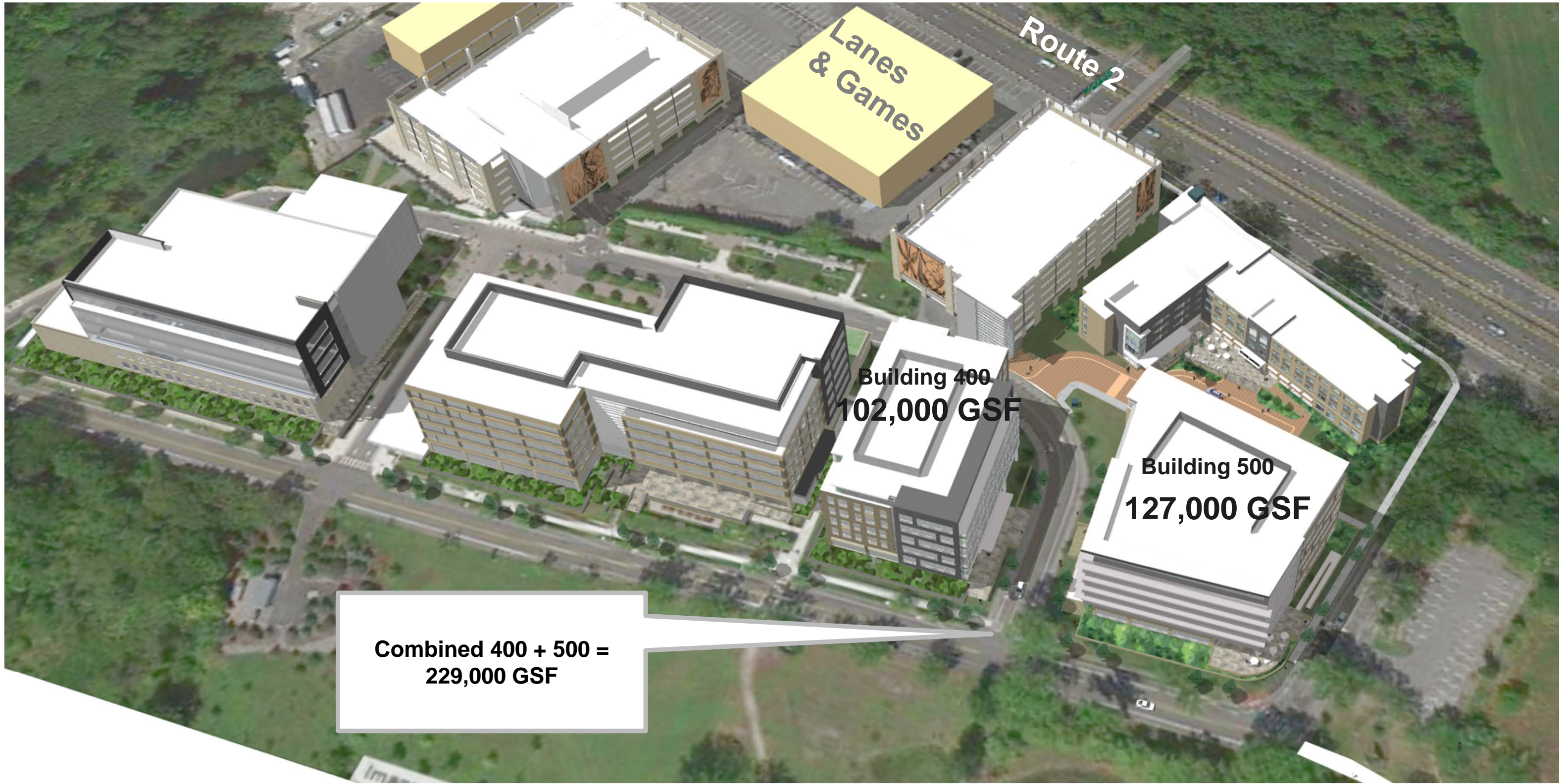

Permitted Site Plan



Building 400 Review

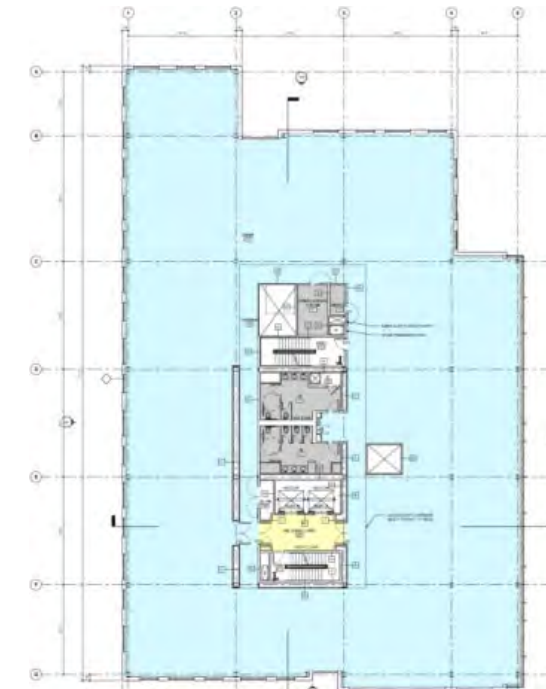

**Typical Floor:
17,196 GSF**



**Ground Floor:
16,095 GSF**

Building 500 Review

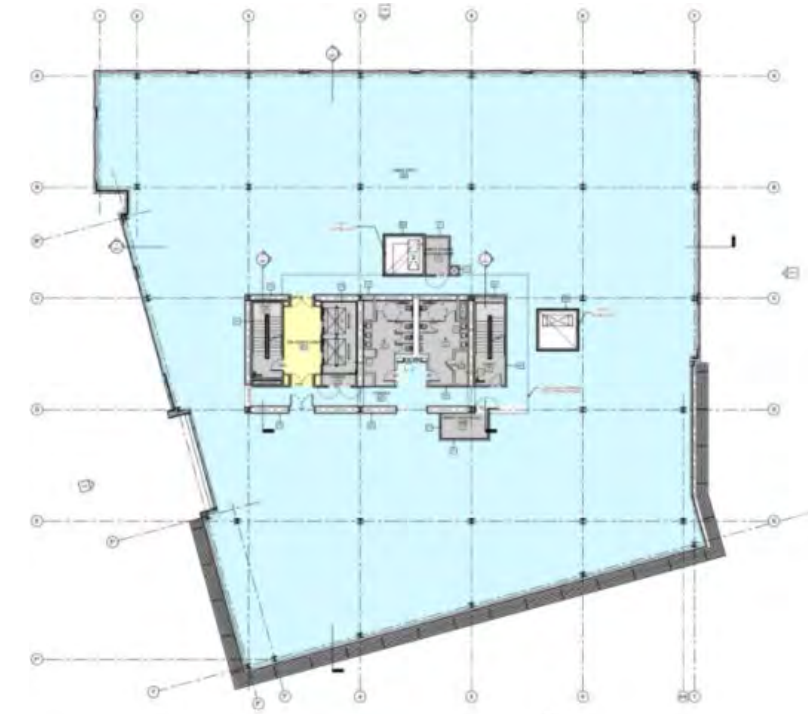

**Typical Floor:
21,318 GSF**

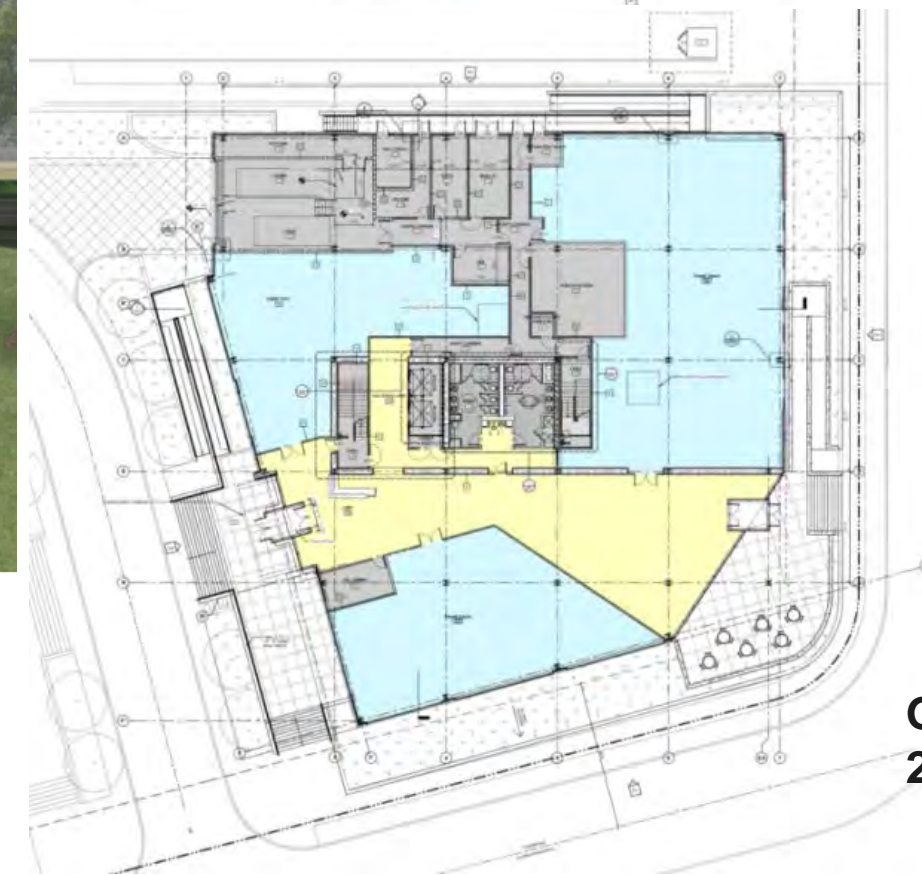

**Ground Floor:
20,320 GSF**



Proposed Revision

Proposed Site Plan



Proposed "Bridge Scheme" Ground Floor

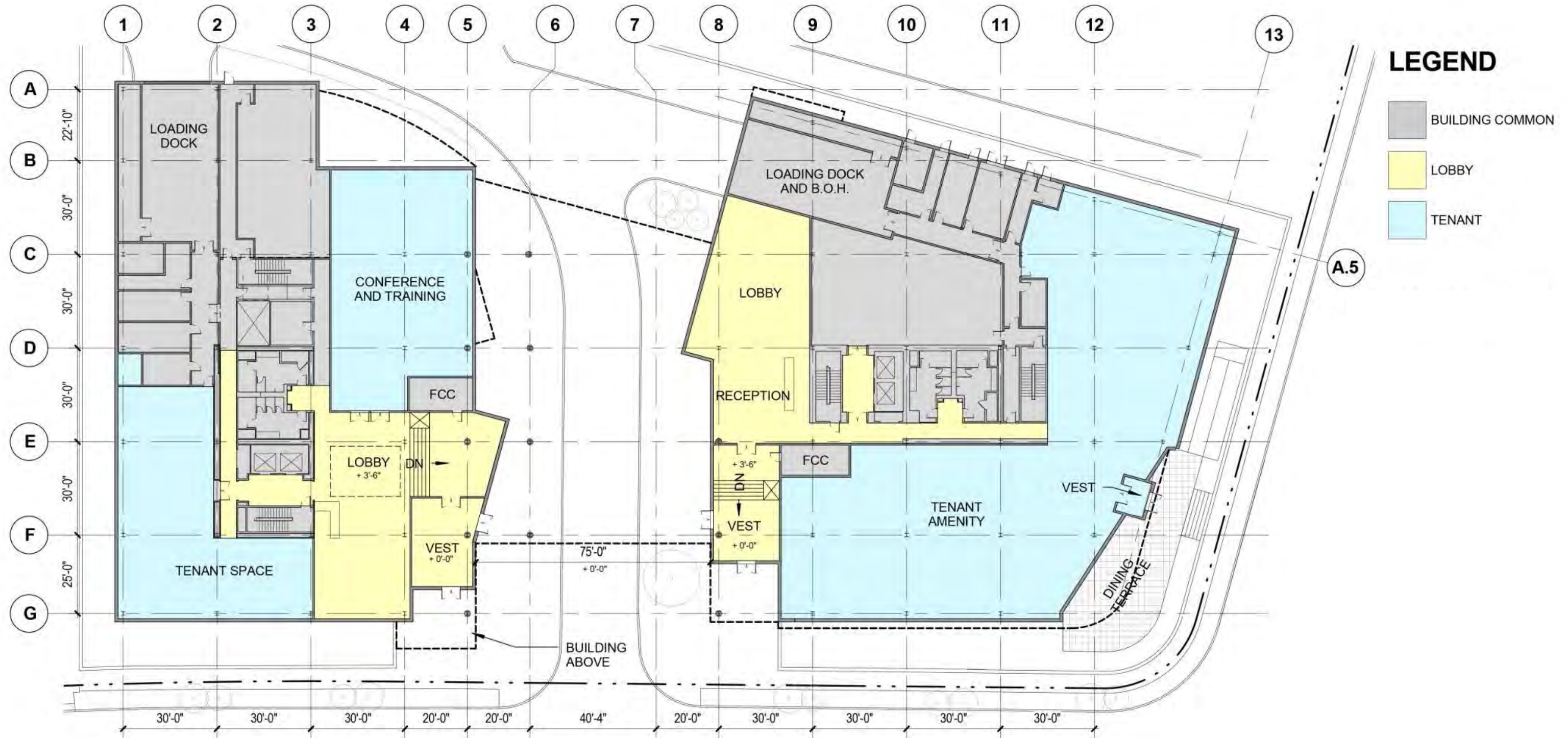

Proposed "Bridge Scheme" Typical Floor

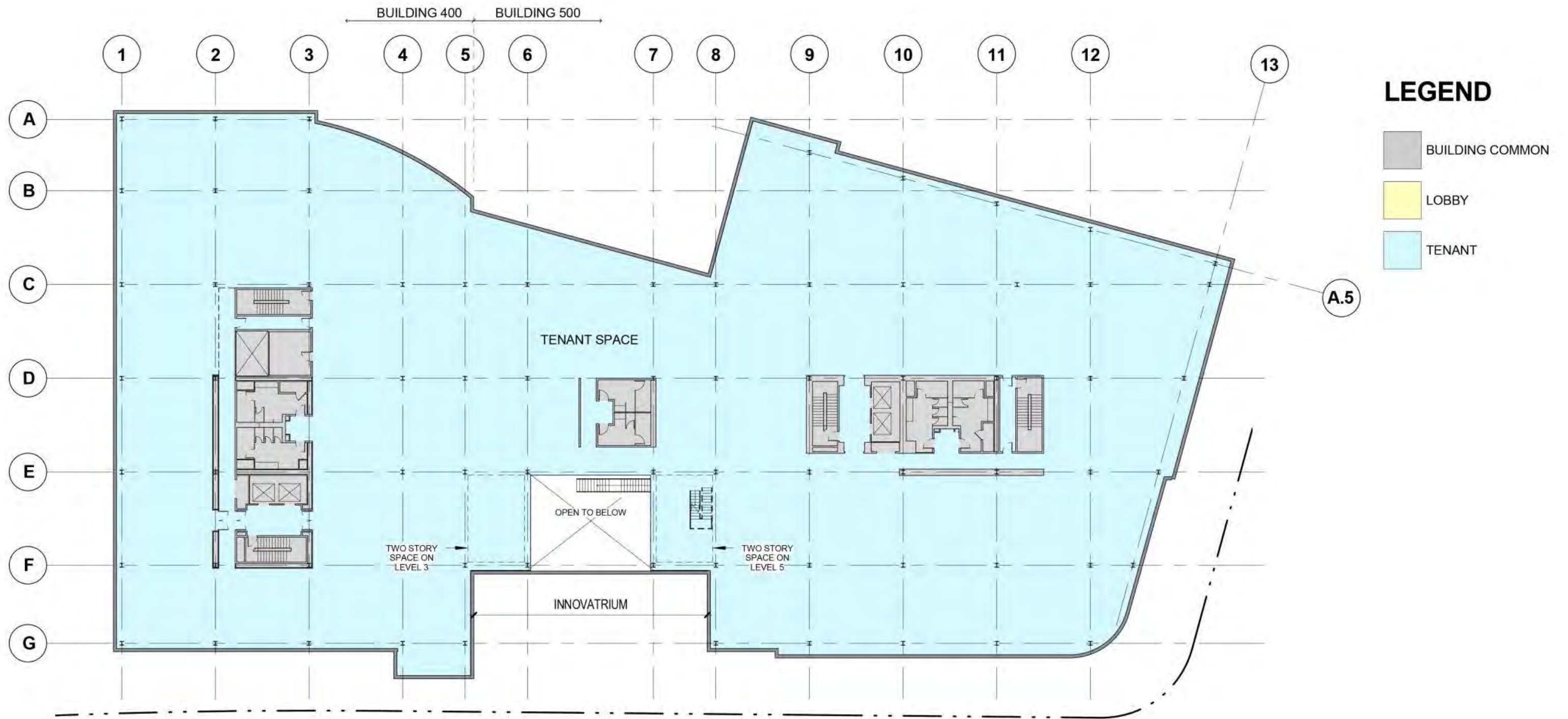

Proposed "Bridge Scheme" 6th Floor



Proposed "Bridge Scheme" Roof Plan

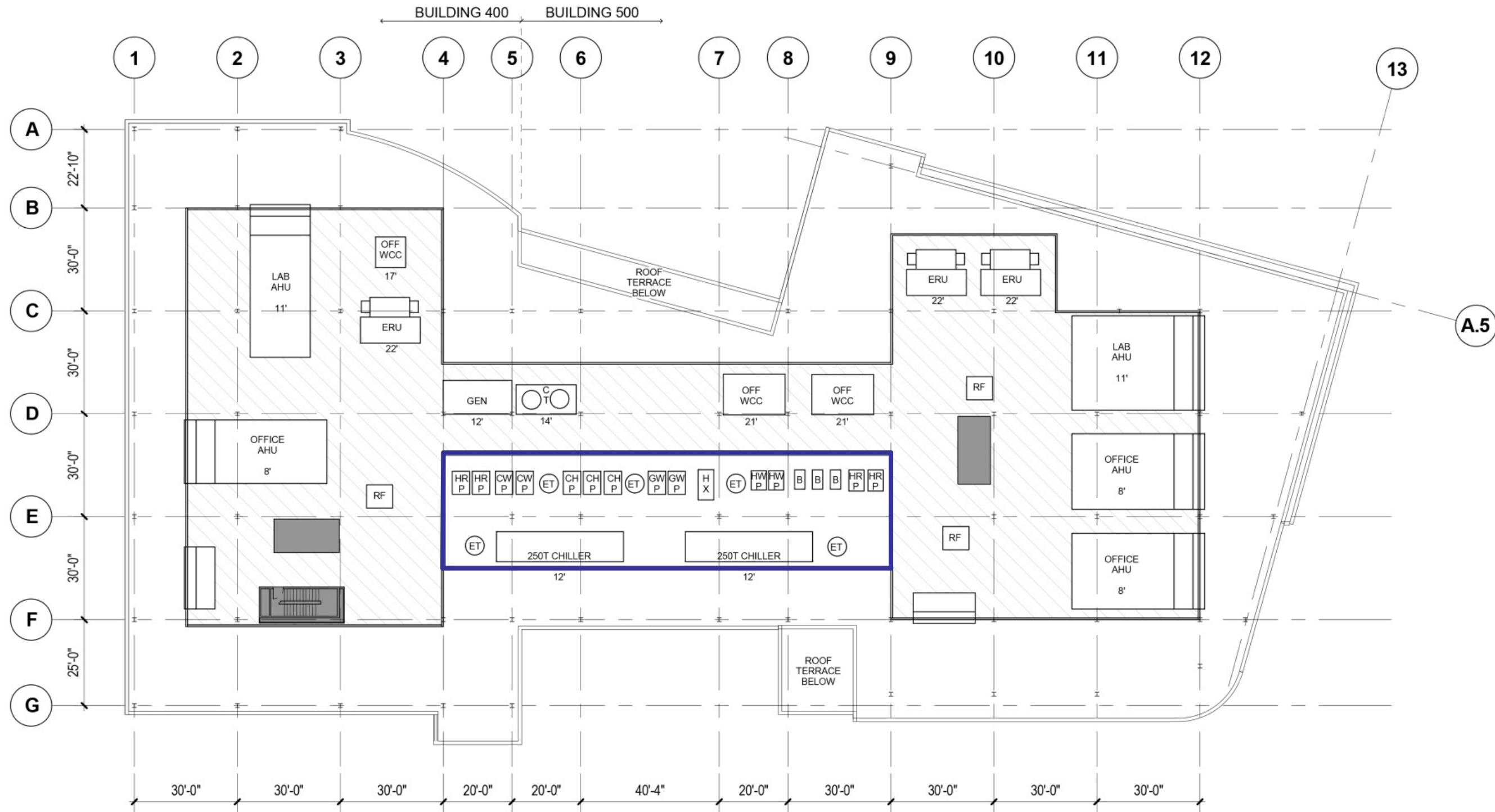

Proposed "Bridge Scheme" Section

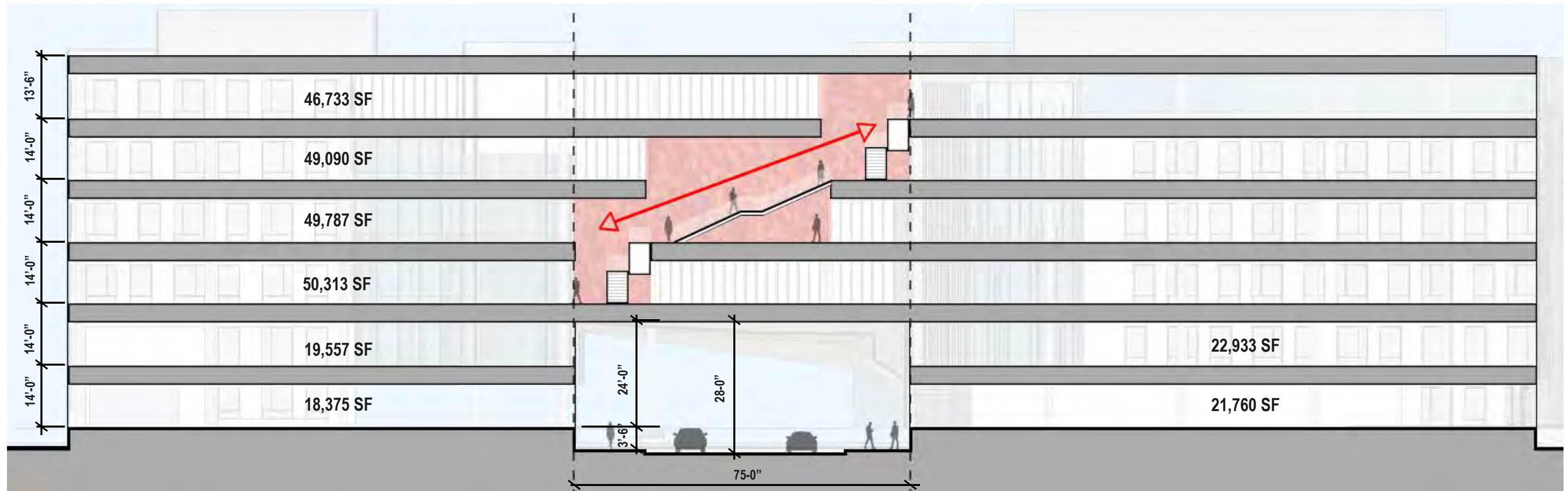
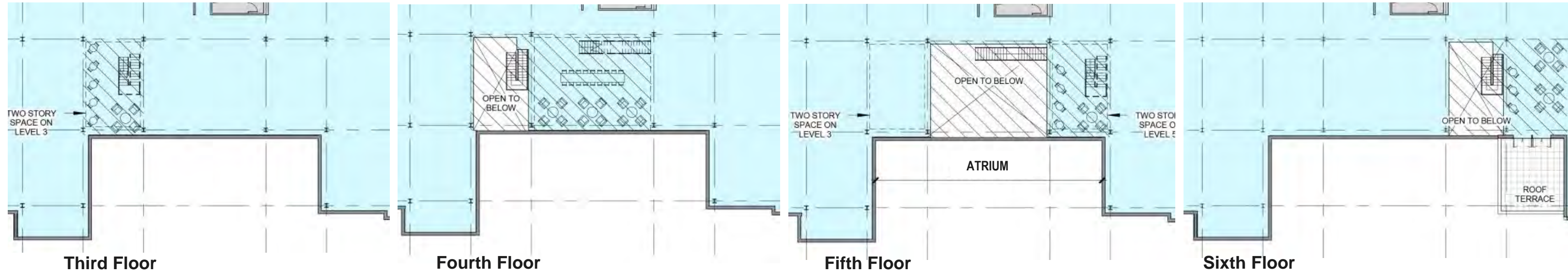

Potential Tenant Atrium

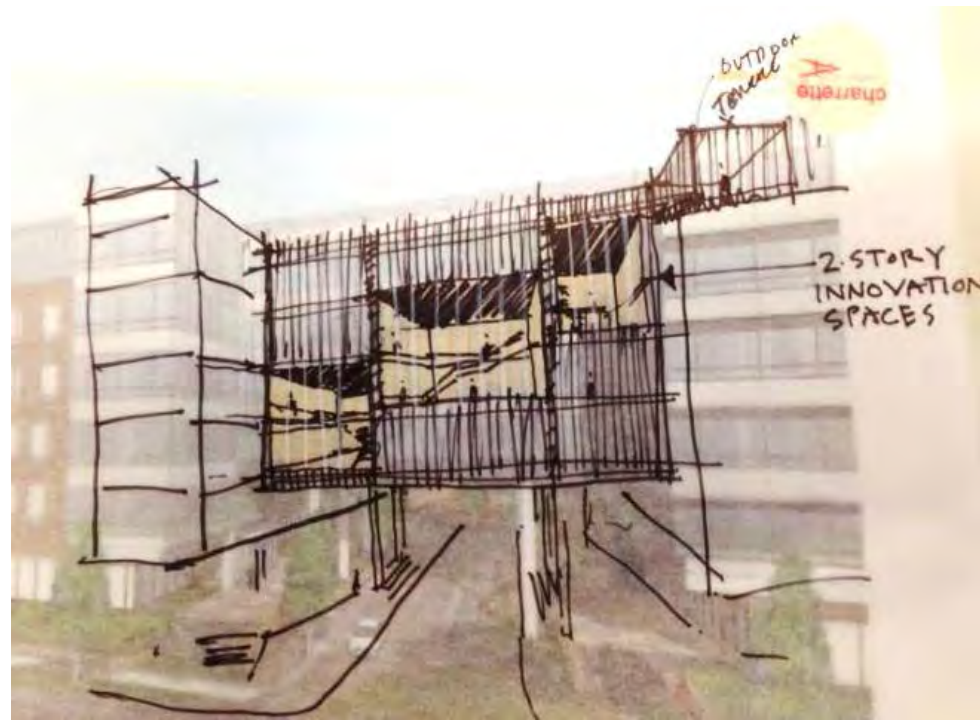





Diagrammatic Massing Evolution

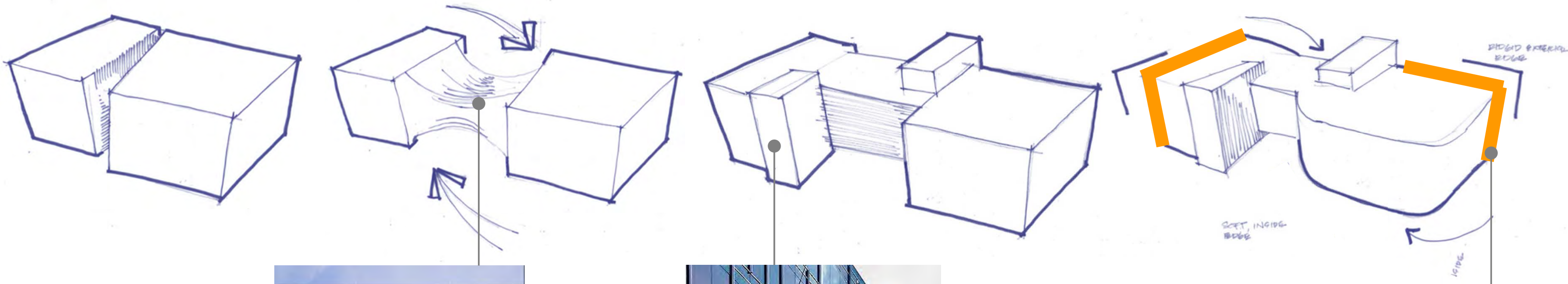

Expressed Wood Curtain Wall

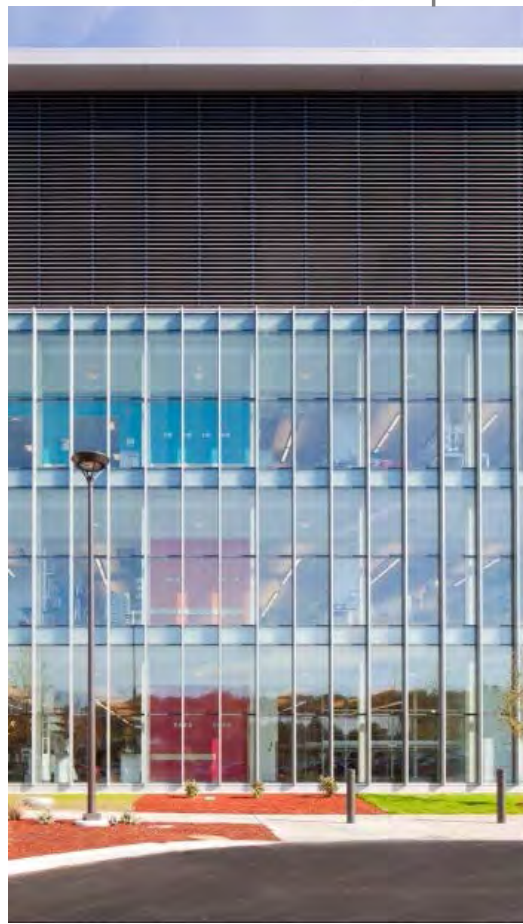

Staggered Vertical Curtain Wall

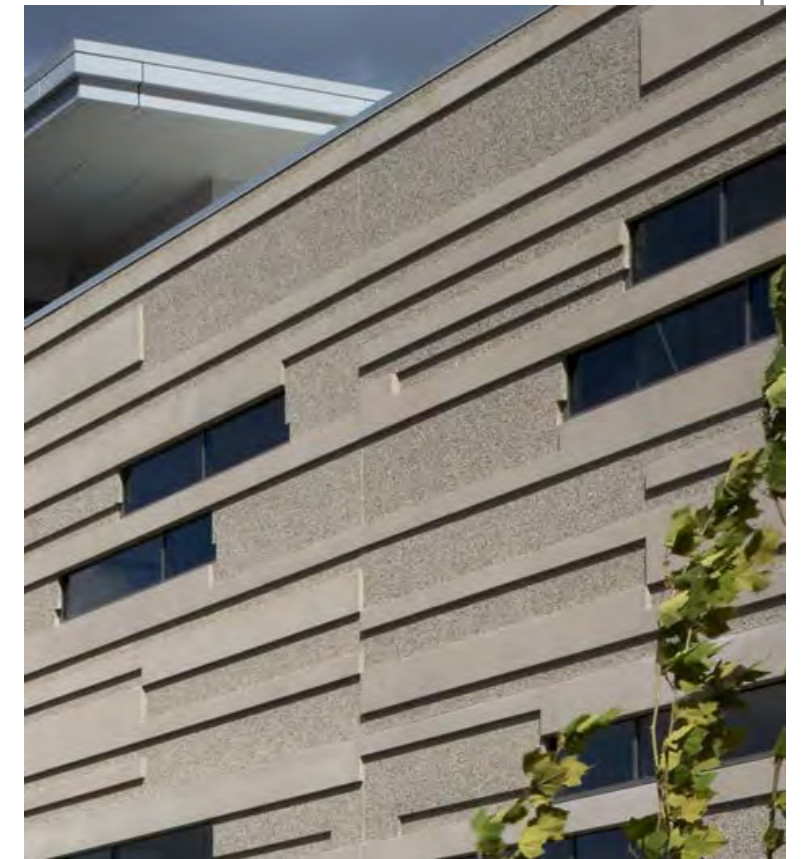

Brown Architectural Precast



View from Alewife Reservation





Ceiling Precedent

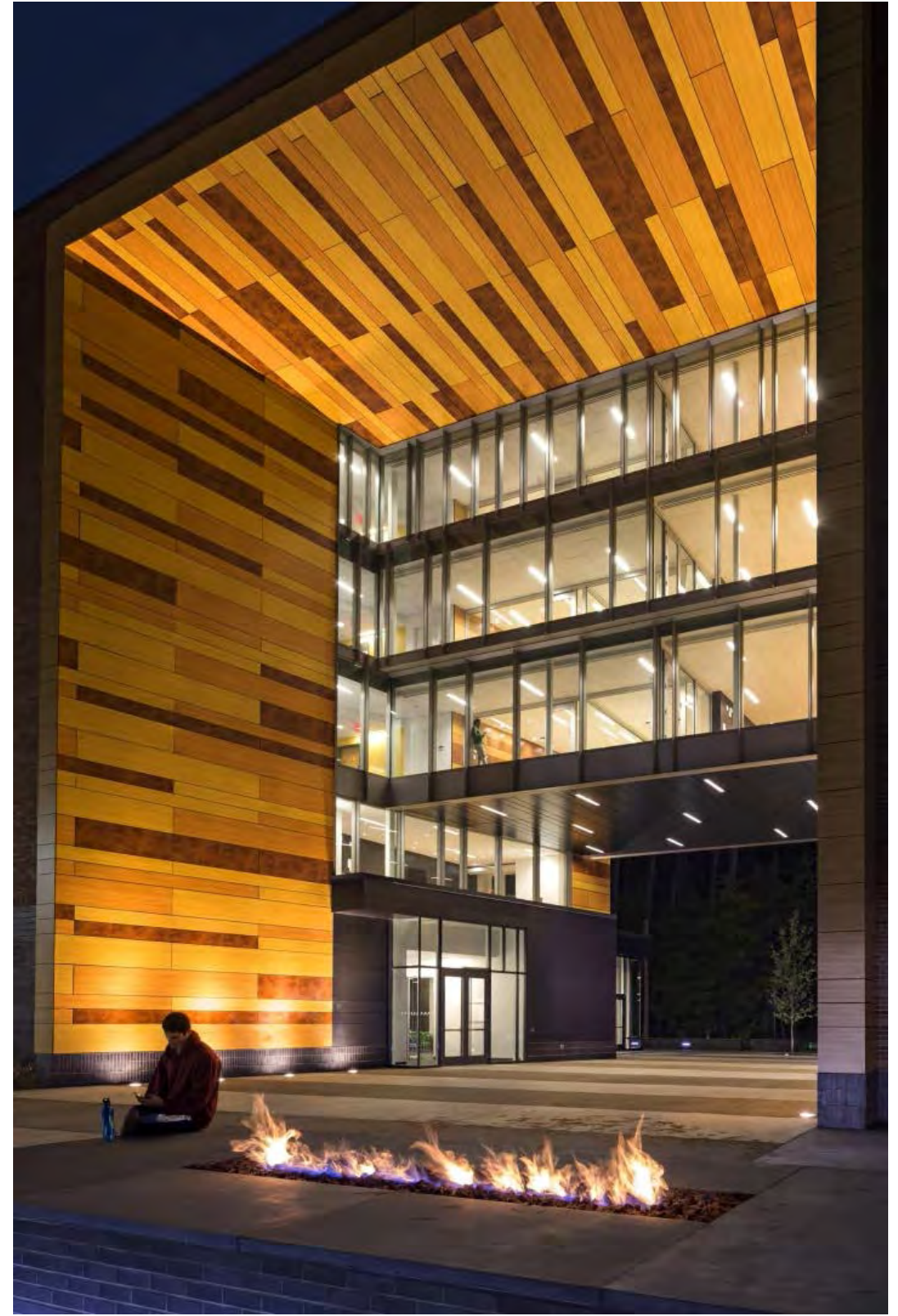





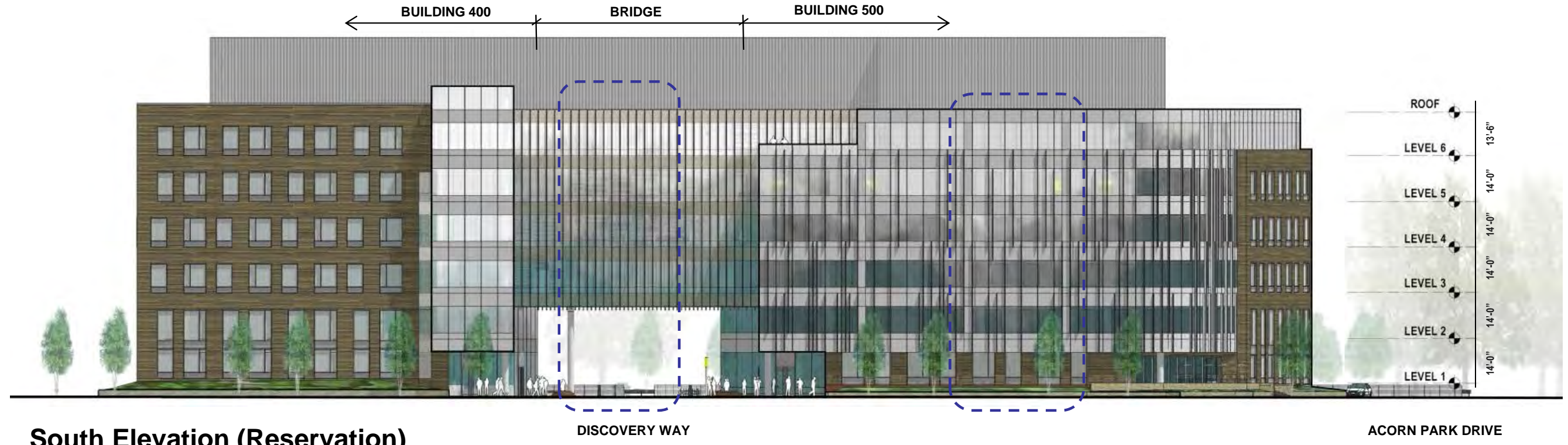

South Elevation (Reservation)

 Indicates Partial Enlarged Elevations Page 27

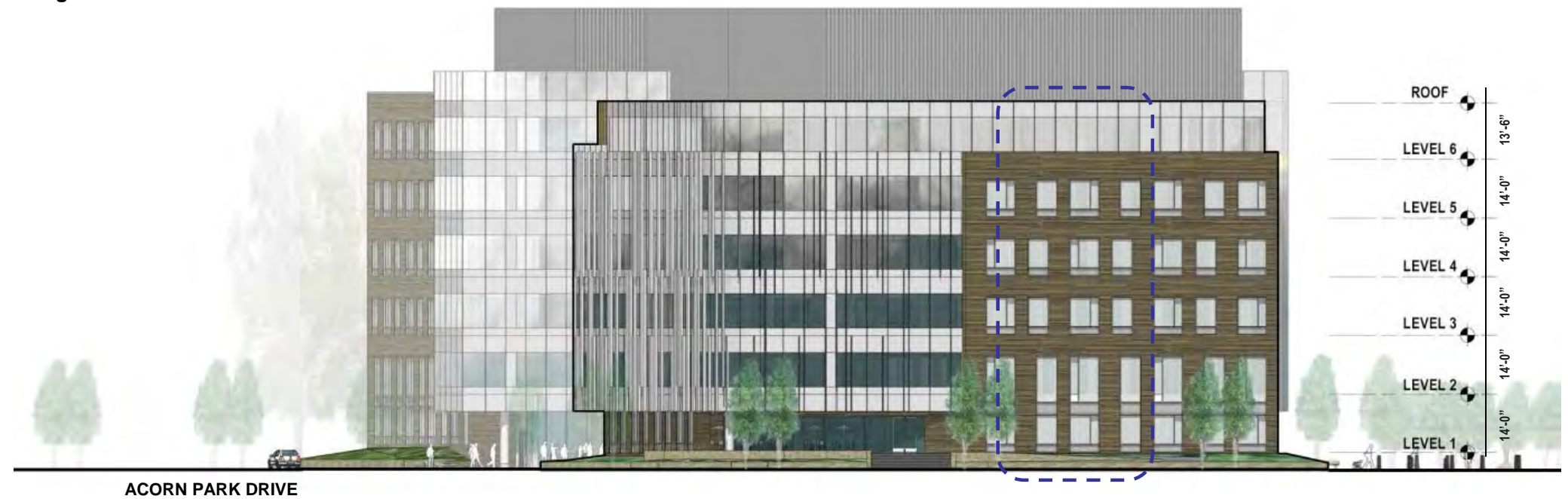

East Elevation (MDC Lot)



West Elevation (Forrester)



North Elevation (Hotel)



Enlarged Elevations



Architectural Precast Detail & Panelization



Panel Concept



Brown Architectural Precast
With 3 Finishes

30'-0"

5'-0"



Typical Spandrel Panel

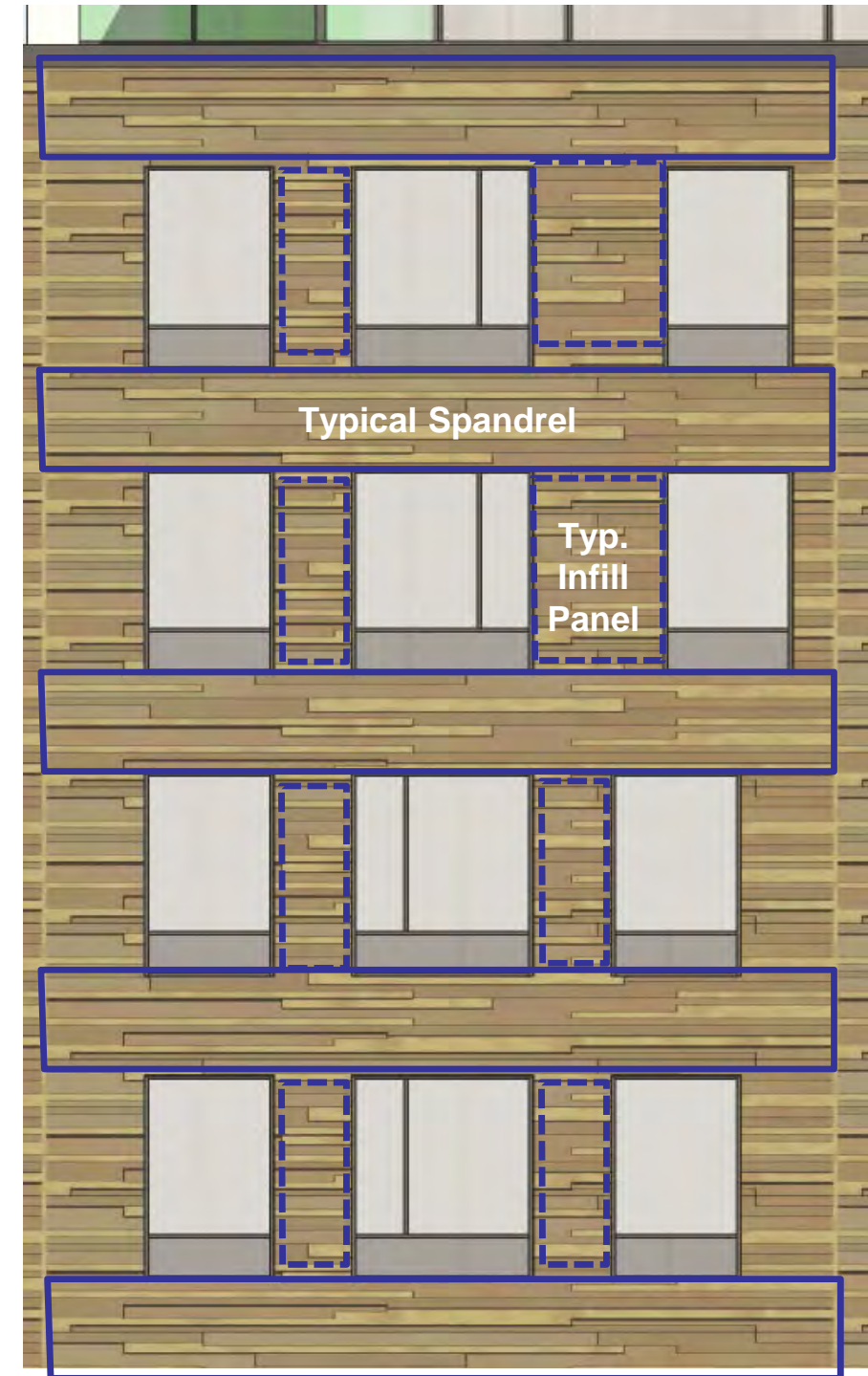

Acorn Park Elevation (Reservation)

Building 100

Building 200 / 300

Building 400 / 500



Shadow Studies: Spring Equinox



March 21, 9AM



March 21, 12PM

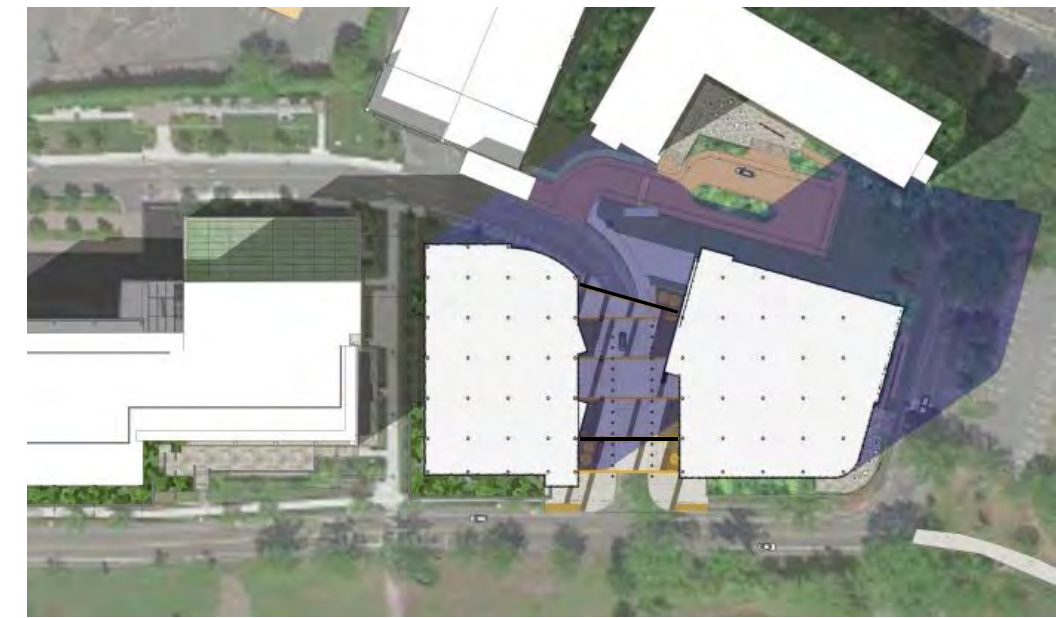

March 21, 3PM

Shadow Studies: Summer Solstice



June 21, 9AM



June 21, 12PM



June 21, 3PM

Shadow Studies: Winter Solstice



December 21, 9AM



December 21, 12PM

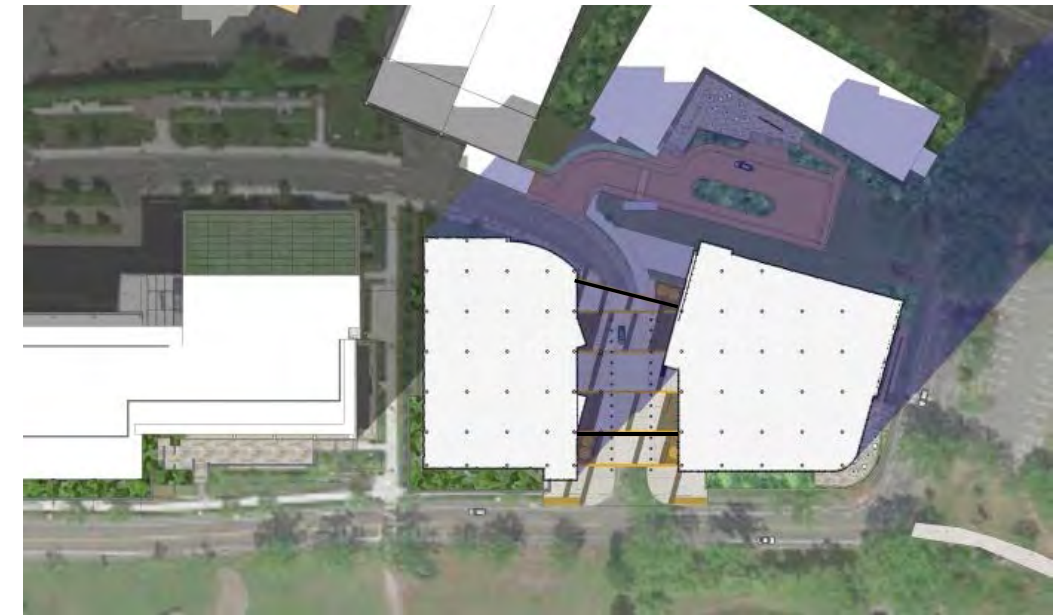

December 21, 3PM

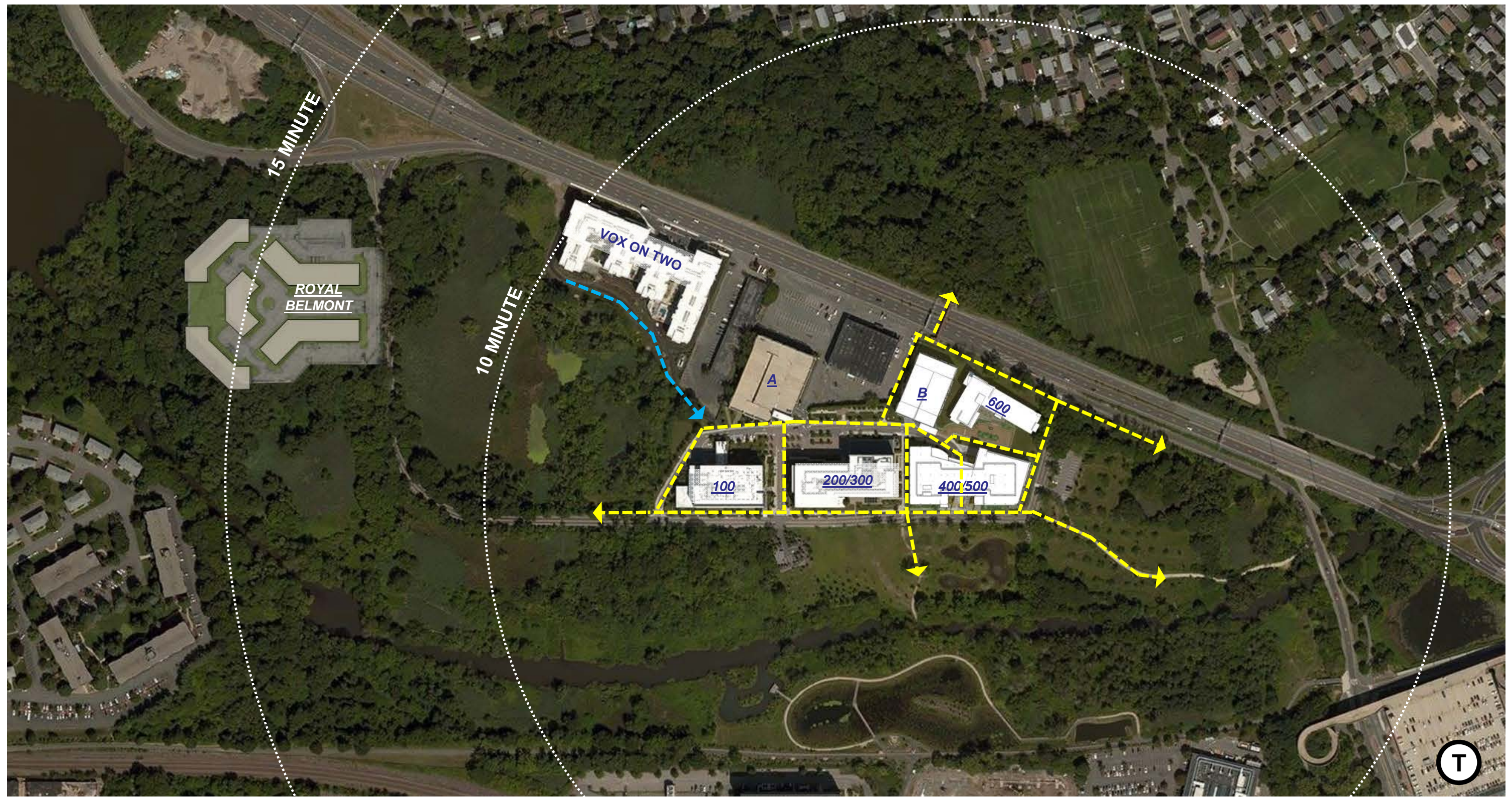

Phasing Options





Materials & Grading Plan

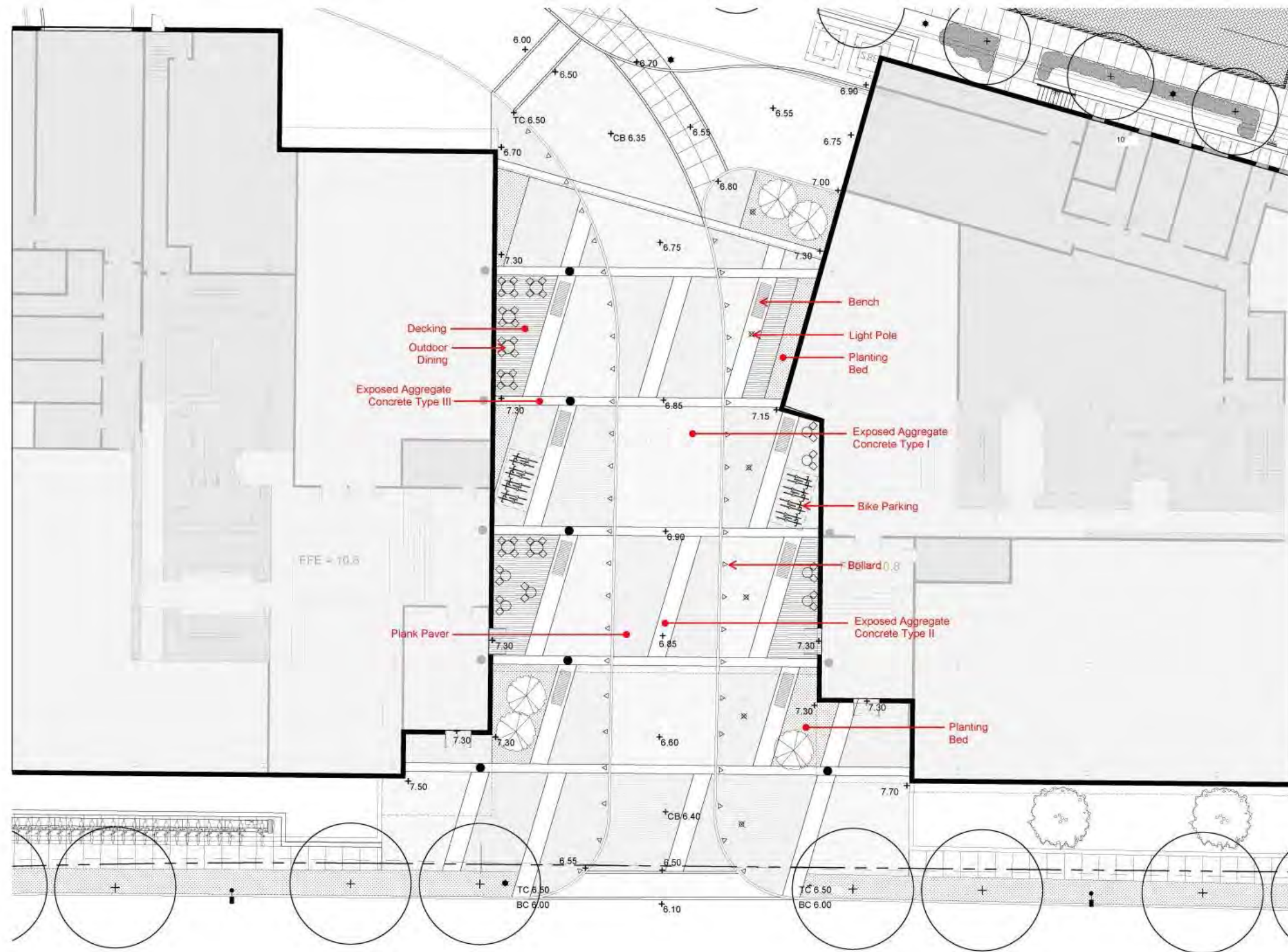

Site Furniture



Hardscape

PROMENADE™ PLANK PAVER

Clean, sleek lines are essential to any modern design. Choose the size, finish and color from Unilock's Promenade Plank Paver series for long narrow paving 'planks' to create a dynamic linear aesthetic to complement any design.

COLORS (Consult your regional Product Data Resource Guide to find locally stocked colors)



BLACK GRANITE Series 3000 Finish
GRANITE BLEND Il Campo Finish
OPAL Smooth Premier Finish
STEEL GREY Smooth Premier Finish

CUSTOM FINISH OPTIONS



UMBRIANO Mottled Finish
SENZO Matte Finish
SERIES 3000 Exposed Aggregate Finish
IL CAMPO Brushed Finish
SMOOTH/PREMIER Finish

CUSTOM COLOR OPTIONS*

Ask your Unilock Representative about locally stocked colors.



PRODUCT SPECIFICATIONS

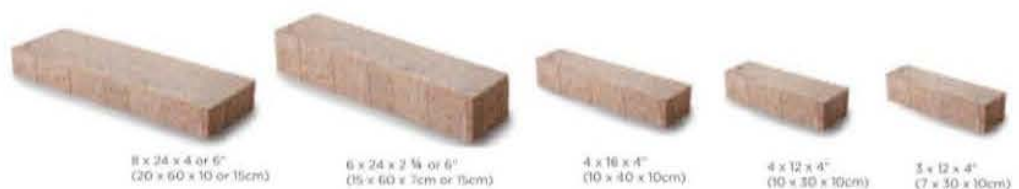

**Promenade™ can be manufactured in a variety of custom colors and textures. Premium quantities will apply. Please contact your Unilock Representative for more details. Permeable version (1 x 12") Eye Promenade™ is available by special order. See page 36.*

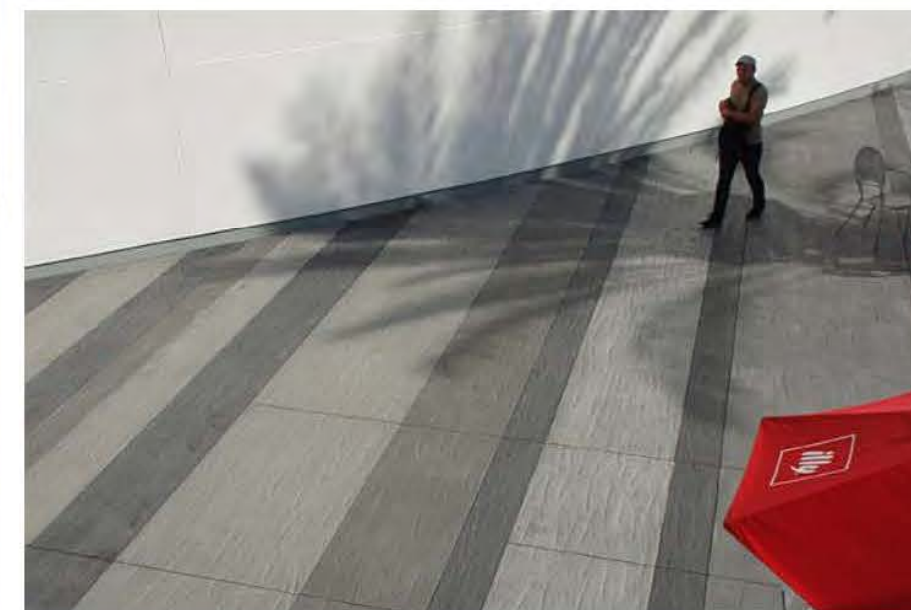

Site Lighting

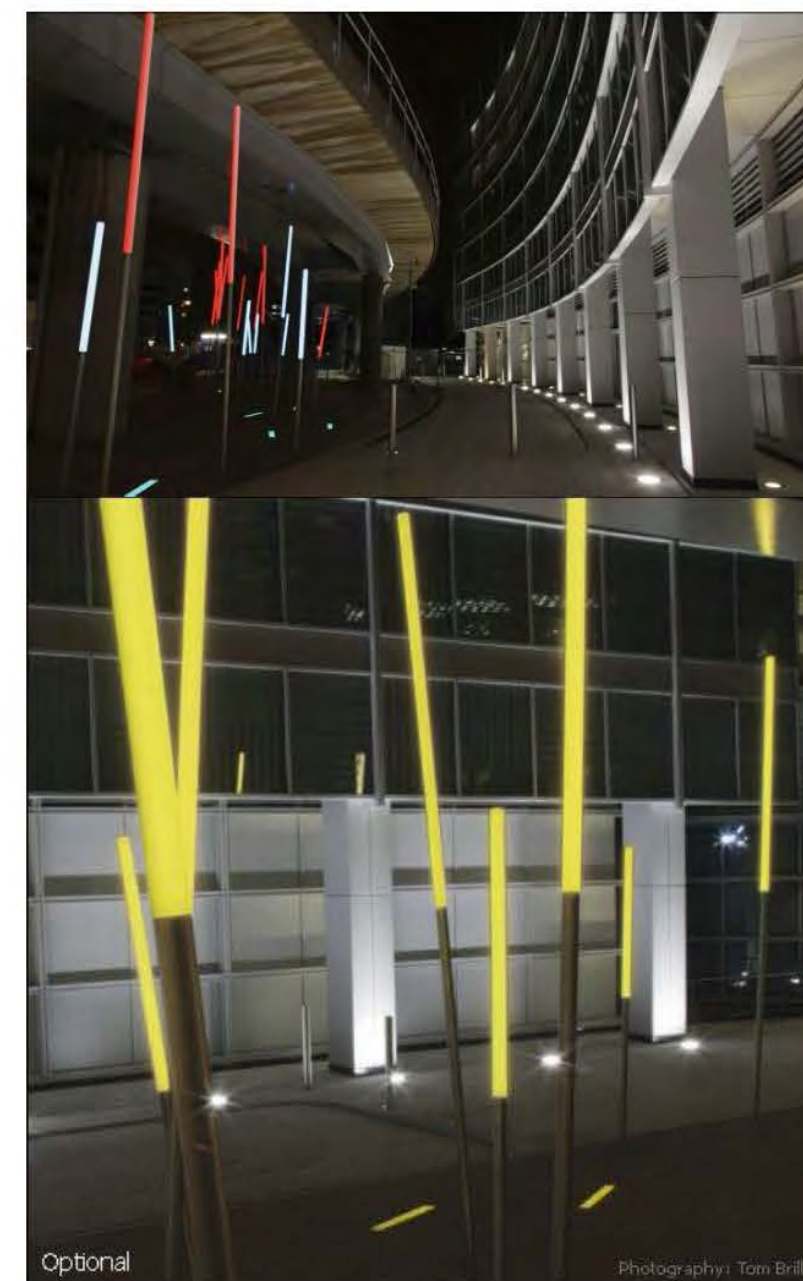
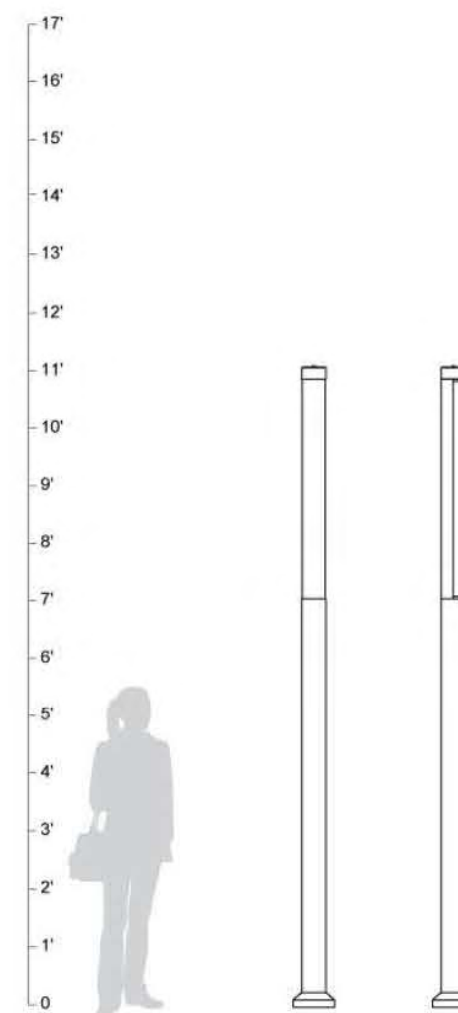
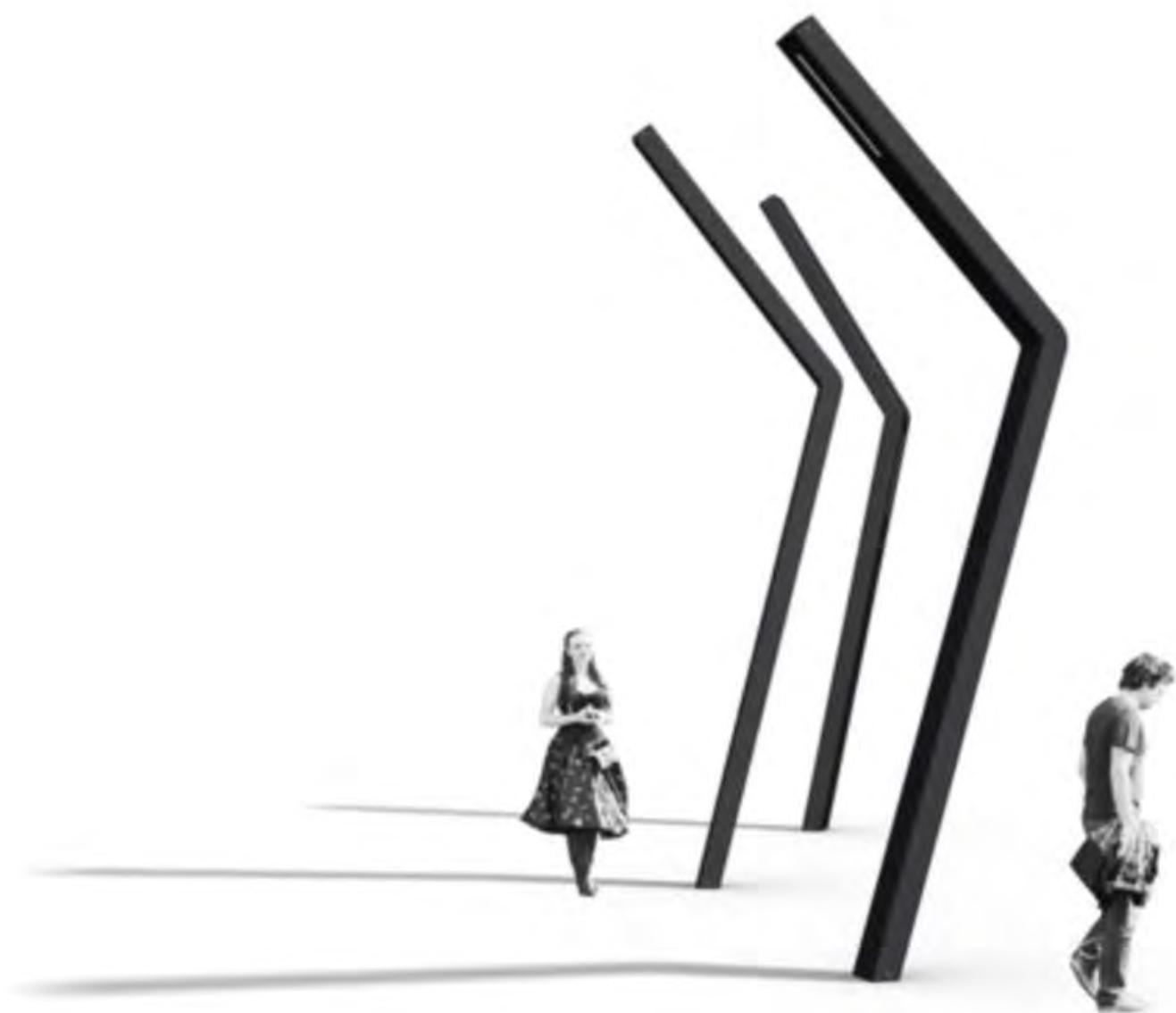

Site Bollards

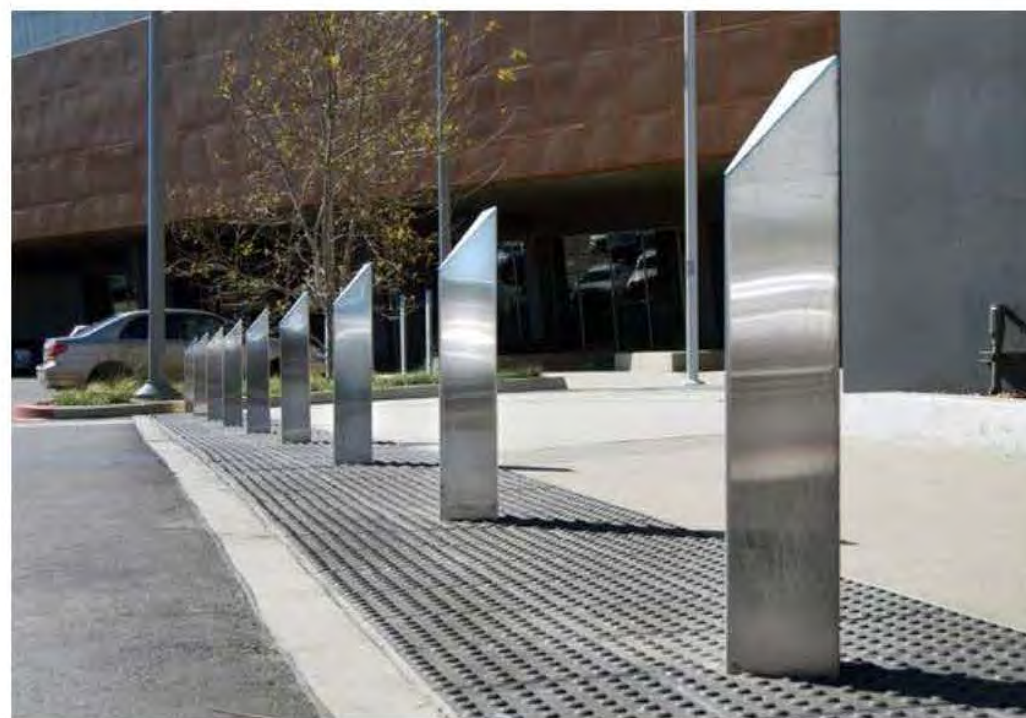
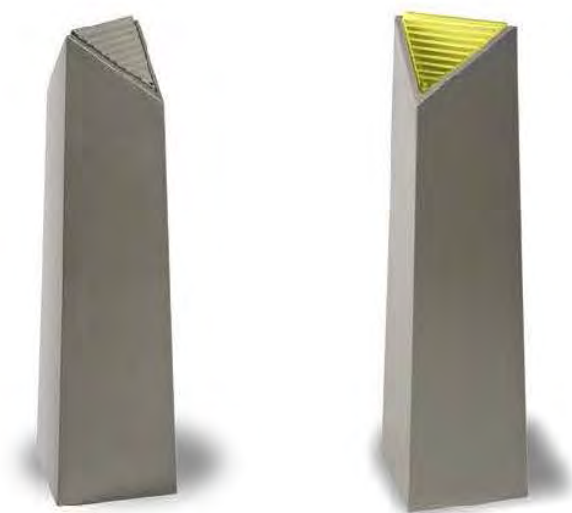

Planting: Partial Shade

