

2022 Annual Report
National Pollutant Discharge Elimination System

For The
City of Cambridge, Massachusetts
Combined Sewer Overflow Permit
#MA0101974

Submitted to
U.S. Environmental Protection Agency
Water Technical Unit

MA Department of Environmental Protection
Bureau of Resource Protection

Submitted by

City of Cambridge
Department of Public Works



I certify under penalty of law that this document and all attachments were prepared under my direction or supervision in accordance with a system designed to assure that qualified personnel properly gather and evaluate the information submitted. Based on my inquiry of the person or persons who manage the system, or those persons directly responsible for gathering the information, the information submitted is, to the best of my knowledge and belief, true, accurate, and complete. I am aware that there are significant penalties for submitting false information, including the possibility of fine and imprisonment for knowing violations.

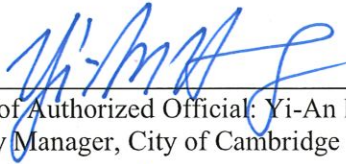

Signature of Authorized Official: Yi-An Huang
City Manager, City of Cambridge



Date

TABLE OF CONTENTS

<u>1. Purpose of Report.....</u>	<u>5</u>
<u>2. Hydraulic Model Updates</u>	<u>5</u>
<u>3. Combined Sewer Overflow Metering Plan</u>	<u>6</u>
3.1 Existing CSO Metering Methodology	6
3.2 Rainfall Characteristics	14
3.3 Summary of 2022 CSO Activations.....	25
3.4 Coordination with MWRA.....	29
<u>4. Status of CSO Abatement Projects</u>	<u>30</u>
4.1 Project Updates	30
<u>5. Modifications to Nine Minimum Controls Plan.....</u>	<u>30</u>

Appendices

APPENDIX I	2022 Precipitation Data
APPENDIX II	2022 Monthly CSO Activations
APPENDIX III	2022 CSO Notifications
APPENDIX IV	2022 Initially Reported and Final Calculated CSO Volumes
APPENDIX V	Plan and Profile Schematics of CSO Regulators

TABLE OF CONTENTS

List of Tables

Table 1 – Summary of Combined Sewer Regulator Structures.....	7
Table 2 – Metered and Modeled CSO Spill Activations and Volumes	13
Table 3 – Frequency of Rainfall Events per Storm Depth Range.....	17
Table 4 – Annual Rainfall Depth Distribution per Storm Depth Range.....	17
Table 5 – Percent of Annual Rainfall Depth per Storm Depth Range.....	18
Table 6 – Number of Storm Events at Selected Ranges of Peak Intensity	19
Table 7 – Comparison of Storms with More Than 1 inch of Rainfall, Typical Year vs 2022.....	20
Table 8 – Comparison of Storms with Peak Intensities Greater than 0.45 in/hr	21
Table 9 – 2022 CSO Results Summary	26
Table 10 – Enhancements to the Nine Minimum Controls Plan	30

List of Figures

Figure 1 – Active CSO Regulator Locations	8
Figure 2 – CAM001 Level Response.....	9
Figure 3 – CAM401A Smart Cover vs Model Level.....	11
Figure 4 – Rain Gauge Locations	14
Figure 5 – April to December 2022 Rainfall from Gauges in and Around Cambridge.....	15
Figure 6 – Typical Year Rainfall Versus 2022 Rainfall	16
Figure 7 – Frequency Comparison of Total Rainfall Depth Distribution by Percentage	18
Figure 8 – Percent of Normal Precipitation in Massachusetts (July-Sept 2022)	22
Figure 9 – Cumulative Rainfall, July-September 2022	23
Figure 10 – Intensity Versus Depth Scatter Chart- Typical Year and 2022 Storm Events	24

1. Purpose of Report

This report has been prepared in accordance with Part I, Section D of Permit No. MA0101974, issued to the City of Cambridge Department of Public Works on September 30, 2009. The permit authorizes the City of Cambridge to discharge flow from twelve (12) Combined Sewer Overflows (CSO) located in eleven (11) regulator structures to the receiving water bodies named in the permit.

The City of Cambridge is additionally required to provide a comparison between the precipitation for the year and the precipitation of the typical year under future planned conditions in the MWRA Final CSO Facilities Plan “Notice of Project Change for the Long Term CSO Control Plan for Alewife Brook” document. Also, required for each CSO is a comparison between the activation volume and frequency for the year and the volume and frequency during a typical year under future planned conditions.

Finally, an evaluation was performed of whether the CSO activation volumes and frequencies for 2022 are in accordance with the estimate in the MWRA Final CSO Facilities Plan, or the report entitled “Notice of Project Change for the Long Term CSO Control Plan for Alewife Brook”, given the precipitation which occurred during the year, and the CSO abatement activities which have been implemented. Where CSO discharges are determined to be greater than the activation frequency or volume in either document, an assessment of the results was completed and documented.

Per the 2019 Variance for Combined Sewer Overflow Discharges to the Alewife Brook / Upper Mystic River Basin and Charles River Basin issued by the Massachusetts Department of Environmental Protection, the City is required to complete an Updated CSO Control Plan for City-owned outfalls. The recommendations in this Report will be used to support creation of that Control Plan.

2. Hydraulic Model Updates

During calendar year 2022, the existing conditions hydraulic model was updated with several system updates as a part of the ongoing system improvement work by the City of Cambridge CDPW. Significant updates and recalibration were completed for areas tributary to the CAM 401A, CAM 401B, and CAM 017 CSO regulators to include recent development and more-accurately simulate dry- and wet-weather flow performance in those areas.

The updated existing conditions model was incorporated into a Unified Hydraulic model co-developed by the City of Cambridge, City of Somerville, and MWRA, who are each developing individual Updated CSO Control Plans to build upon the current MWRA CSO Long-Term Control Plan. The Unified Model includes updates from all three parties, representing the most-current representation of existing conditions in the respective pipeline networks. Model results presented in this report were generated from that Unified Model.

3. Combined Sewer Overflow Metering Plan

As part of the 2022 Annual CSO reporting process, a review of the available meter data for 2022 was performed. This data review identified periods with good-quality meter data that could be used for calculating CSO statistics and comparison to model simulation results. CSO activations and volumes presented in this report are based on calculations from flow monitoring data. This section provides an overview of the City's CSO metering program, the modeled CSO simulations, and the correlation between the two at each CSO regulator.

3.1 Existing CSO Metering Methodology

3.1.1 Existing CSO Structures

In accordance with the City's current CSO permit, the city has a total of twelve combined sewer outfalls that receive overflows from eleven regulator structures, listed in **Table 1** and shown in **Figure 1**. Five outfalls are located on the Charles River and seven outfalls are located on Alewife Brook.

Seven of the twelve existing CSOs are currently open: four located on the Alewife Brook and three on the Charles River. On Alewife Brook, the CAM 004 and CAM 400 regulators were permanently closed and CAM 002B regulator is temporarily closed. On the Charles River, both CAM 009 and CAM 011 have been temporarily closed.

Table 1 – Summary of Combined Sewer Regulator Structures

Regulator	Location	Status	Waterbody
CAM 001	Alewife Brook Parkway @ Foch St.	Open	Alewife Brook
CAM 002	2A-Massachusetts Ave. at Alewife Brook Parkway	Open	Alewife Brook
	2B-Massachusetts Ave. at Alewife Brook Parkway	Closed ¹	Alewife Brook
CAM 004	Fresh Pond Rotary	Closed ²	Alewife Brook
CAM 400	Alewife Brook Parkway and Harrison Avenue	Closed ³	Alewife Brook
CAM 401A	Sherman Street at railroad crossing	Open	Alewife Brook
CAM 401B	Massachusetts Ave. at Alewife Brook Parkway	Open	Alewife Brook
CAM 005	Mount Auburn Street @ Lowell Street	Open	Charles River
CAM 007	Memorial Drive at Hawthorne Street	Open	Charles River
CAM 009	Memorial Dr. at Old Murray Rd.	Closed ⁴	Charles River
CAM 011	Plympton St. @ Memorial Dr.	Closed ⁴	Charles River
CAM 017	Binney Street at Land Blvd.	Open	Charles River

¹Temporarily closed, City retains the right to re-open, will be reevaluated as part of the Updated CSO Control Plan

²Permanently closed on December 27, 2015

³Permanently closed on March 31, 2011

⁴Temporarily closed, City retains the right to re-open, will be reevaluated as part of the Updated CSO Control Plan

Figure 1 – Active CSO Regulator Locations

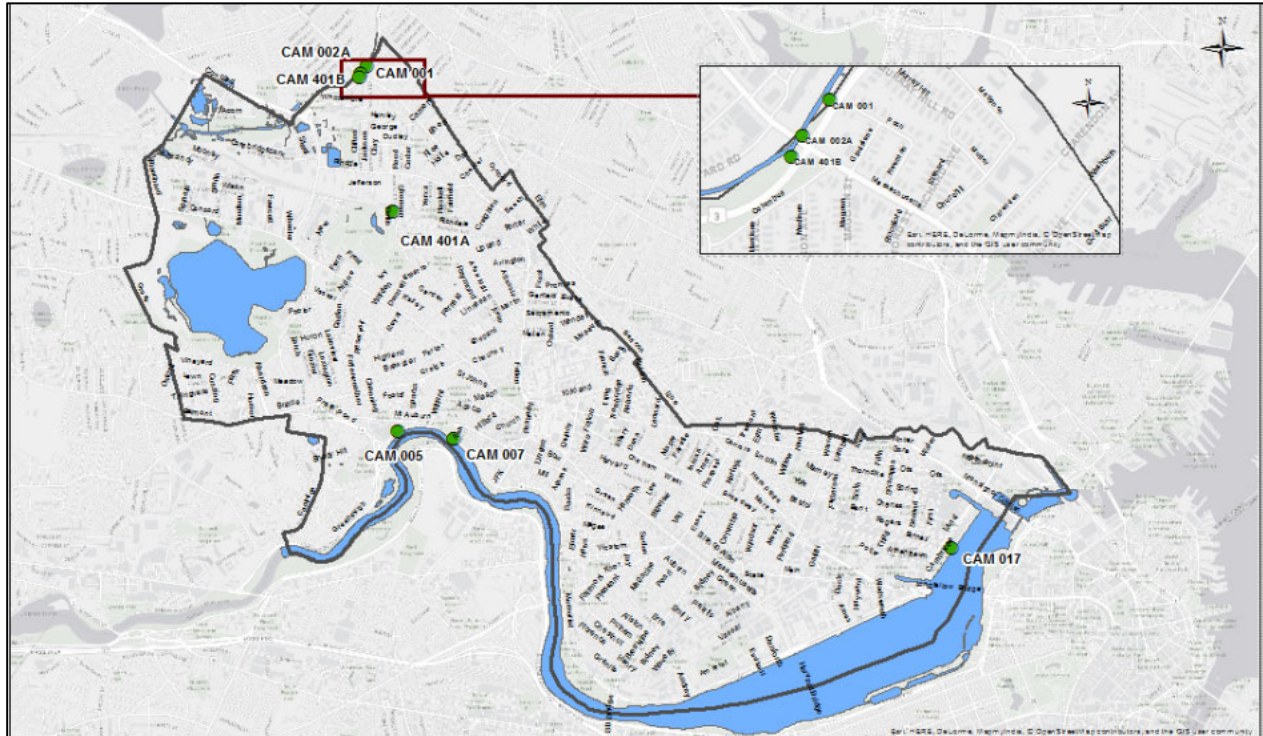

3.1.2 CSO Metering and Recommendations

The following section outlines the 2022 CSO spill counts and volumes, along with the methodology for CSO metering at each regulator. The data analysis carried out on both the metered and modeled CSO simulations helped identify actions that the City will undergo for CSO metering moving into 2023. These actions include continued routine maintenance and calibration of sensors installed in regulators. This improves the availability of high-quality data that assists accurate reporting and supports refinement and calibration efforts to improve model simulation results. Specific metering issues are discussed in the following sections. The number of activations and total volumes for the Alewife Brook and Charles River CSOs are presented in **Table 2**.

CAM 001 Metering

Metering results indicated no spills at CAM 001 in 2022.

The CAM 001 regulator is monitored by an outfall pipe area-velocity sensor and a level sensor in the regulator manhole. On January 17, 2022, the water level in the outfall pipe was observed to be elevated for an extended period following a wet weather response, as shown in **Figure 2**. Similar response was observed in the level data on three more occasions, each following a wet weather event. This is uncharacteristic of CSO spills at this location, which are typically short duration with a rapid rise and decline in water level at the regulator. Upon investigation, the levels were found to be correlating well with the Alewife Brook gauge height. As a result, the observed responses in the outfall meter were likely due to higher levels in the Alewife Brook creating backwater in the outfall pipe, and not CSO spills.

The City will conduct a field investigation of the CAM 001 regulator to verify these backwater conditions.

Hydraulic model results also indicated no spills at CAM 001 in 2022.

Figure 2 – CAM001 Level Response

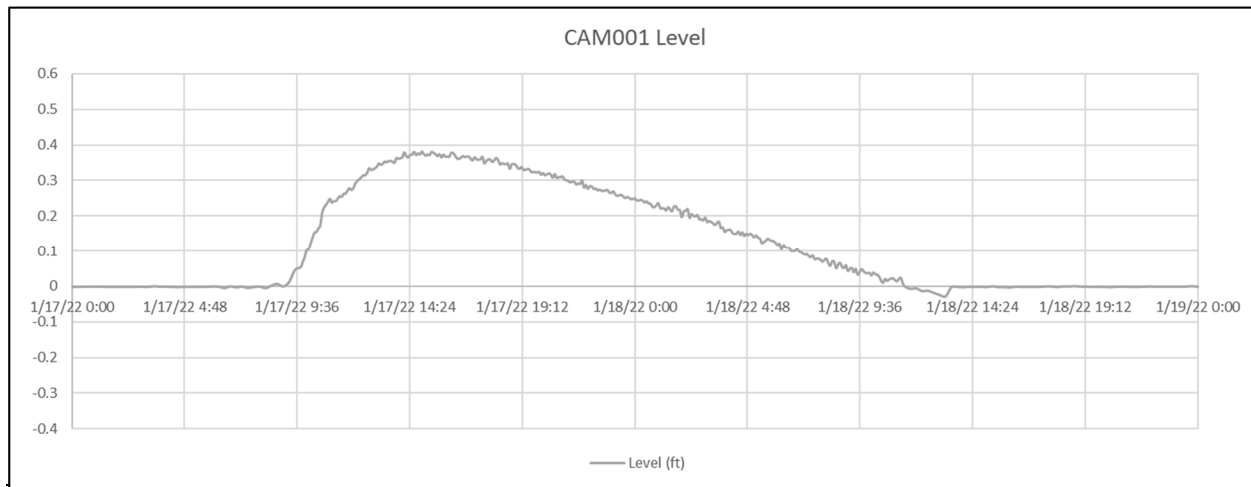

CAM 002 Metering

Metering results indicated no spills at CAM 002 in 2022.

The City maintains a level sensor located in the regulator and a flow meter located in the CAM 002A outfall pipe.

Hydraulic model results also indicated no spills at CAM 002 in 2022.

CAM 004 Metering

The CAM 004 outfall was permanently closed on December 27th, 2015, in accordance with the MWRA’s LTCP for the Alewife Brook.

CAM 400 Metering

The CAM 400 CSO regulator was permanently closed in March 2011 in accordance with the MWRA’s LTCP for the Alewife Brook.

CAM 401A Metering

Metering results identified ten (10) CSO spills at CAM 401A in 2022 with a total spill volume of less than or equal to 0.47 MG.

The CAM 401A regulator structure includes a floatables control brush screen mounted on a static weir structure and flap gates located just downstream from the weir. There is no underflow connection to the MWRA network at CAM401A, only an overflow weir; all dry-weather and low wet-weather flows are conveyed through the City combined sewer network to the MWRA-owned MWR003 regulator, on Alewife Brook at the MBTA Alewife Station. The city has a level sensor in the combined sewer pipeline and a Smart Cover level sensor in the manhole located between the combined sewer and the weir.

There is also a flow meter downstream from the overflow weir that is intended to validate when spills occur by providing positive flow readings. However, the 2022 data for this meter did not correlate with other monitoring data at the regulator and showed no response during many CSO events. For example, the meter data showed no wet-weather response following the October 14, 2022 event, which was the largest CSO event at CAM 401A in 2022. As a result, this meter was not used for validating CSO occurrences in 2022. It is recommended that this meter be checked and recalibrated in 2023.

Hydraulic model results indicated four CSO spills at CAM 401A in 2022 with a total spill volume of 0.22 MG. The CAM 401A contributing area had extensive model updates and recalibration completed as part of the City's ongoing model improvement efforts.

While the model under-reported the total spill volume for 2022, the level in the model still correlated well with metered levels in the CAM 401A regulator. Seven of the ten spills had discharge volumes of less than 10,000 gallons and durations of 20 minutes or less. For these short duration, low-volume (metered) spills, the level in the model came within a few inches of the spill threshold, as shown below in **Figure 3** for the January 17, 2022 event. While the model is calibrated within acceptable guidelines established by the Chartered Institution of Water and Environmental Management (CIWEM), the City will continue to monitor the correlation between modeled and metered results, particularly during larger storms that were not seen in the 2022 reporting year.

Figure 3 – CAM401A Smart Cover vs Model Level

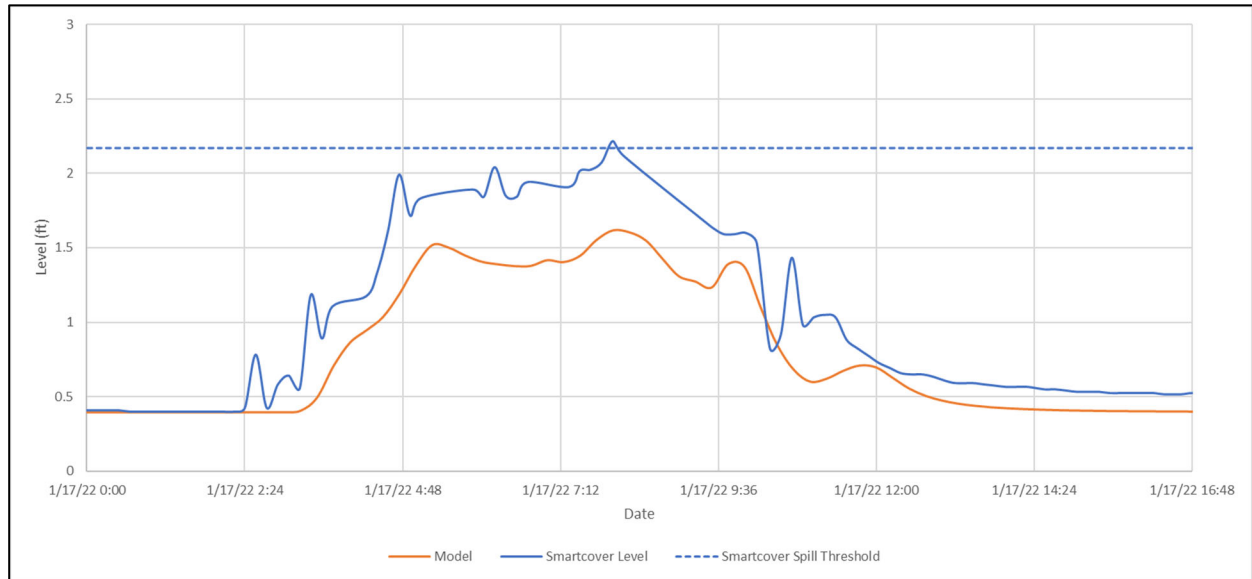

CAM 401B Metering

Metering results indicated no spills at CAM 401B in 2022.

The City has a level sensor and area-velocity sensors installed in the CAM 401B regulator structure and outfall pipe respectively. Analysis of data from the outfall pipe showed the sensor failing on multiple occasions, where the data was observed to return to a default, ‘error’ state. These occurrences did not correlate with rainfall occurrences and, therefore, were not the result of a wet-weather response. The City will check the flow-monitoring setup and related data processing for the sensors in the CAM 401B outfall pipe in 2023.

Hydraulic model results also indicated no spills at CAM 401B in 2022.

CAM 005 Metering

Metering results identified four spills at CAM 005 in 2022 with a total discharge volume of 0.16 MG.

The CAM 005 regulator is a multi-chamber structure that is metered with a depth and velocity sensor mounted on the upstream side of the overflow weir. Additionally, a Smartcover level sensor is installed in MH D32CMH0215, which is immediately upstream from the south side of the regulating structure.

Hydraulic model results indicated no spills at CAM 005 in 2022. The four metered spills were all observed to be of short duration with relatively low discharge volumes. Modeled levels at the regulator were observed to rise corresponding to the metered levels, but the modeled levels never exceeded the overflow weir elevation. Potential reasons for the differences are discussed in further detail in Section 3.3.2.

CAM 007 Metering

Metering results indicated no spills at CAM 007 in 2022.

The CAM 007 regulator has a level and velocity sensor mounted on the overflow weir in the regulator structure. Flow monitoring data indicated erratic calculated flow data with no corresponding velocity measurements. This could be an issue with either the sensor calibration or the post processing algorithm. Inconsistent velocity information has been observed at the CAM007 regulator during previous reporting years as well. The velocity sensor will be checked, recalibrated, and possibly relocated to provide better data for CSO monitoring and model calibration purposes.

Hydraulic model results indicated no spills at CAM 007 in 2022.

CAM017 Metering

Metering results indicated no spills at CAM 017 in 2022.

The CAM 017 regulator has flow meters installed on the incoming 72-inch diameter combined sewer on Binney Street and on one of the static weir crests. There is also an inclinometer mounted on the counterweight pulley on the largest bending weir in the regulator. The inclinometer did not register any movement in 2022, so this device was not used to validate CSO occurrences. The City will perform a maintenance check on the bending weirs and verify that the inclinometer is functioning properly in 2023.

Hydraulic model results indicated no spills at CAM 017 in 2022. The CAM 017 contributing area had extensive model updates and recalibration completed as part of the City's ongoing model improvement efforts.

Table 2 – Metered and Modeled CSO Spill Activations and Volumes

Outfall	2022 Metered CSO Spills	Metered Volume (MG)	2022 Modeled CSO Spills	Meter Type (Threshold)
ALEWIFE BROOK				
CAM 001	0	0.00	0	Outfall Meter (Depth, Vel > 0)
CAM 002	0	0.00	0	Level Sensor (Depth > 9.78')
CAM 401A	10	0.47	4	Level Sensor (Depth > 2.17')
CAM 401B	0	0.00	0	Level Sensor (Depth > 5.47')
Total	10	0.47	4	
CHARLES RIVER				
CAM 005	4	0.16	0	Area Velocity Sensor (Depth, Velocity>0) Validated by Level Sensor
CAM 007	0	0.00	0	Area Velocity Sensor (Depth, Velocity >0)
CAM 017	0	0.00	0	Area Velocity Sensor (Depth, Velocity>0)
Total	4	0.16	0	

3.2 Rainfall Characteristics

In accordance with the City’s National Pollutant Discharge Elimination System (NPDES) Permit MA0101974, the CSO Annual Report must include an analysis of precipitation data from the previous calendar year (2022) compared to the MWRA Typical Year rainfall record.

The City of Cambridge currently operates rain gauges on the roof of the Cambridge DPW building and at the Water Department near Fresh Pond. In 2022 the city operated gauges were operational from April 1st to December 31st. Other rain gauges in the vicinity include the USGS gauges located at Fresh Pond in Cambridge and Muddy Brook in Brookline respectively, and the BWSC gauge located at Day Square in East Boston. **Figure 4** shows the location of the rain gauges analyzed for the 2022 reporting year.

Figure 4 – Rain Gauge Locations

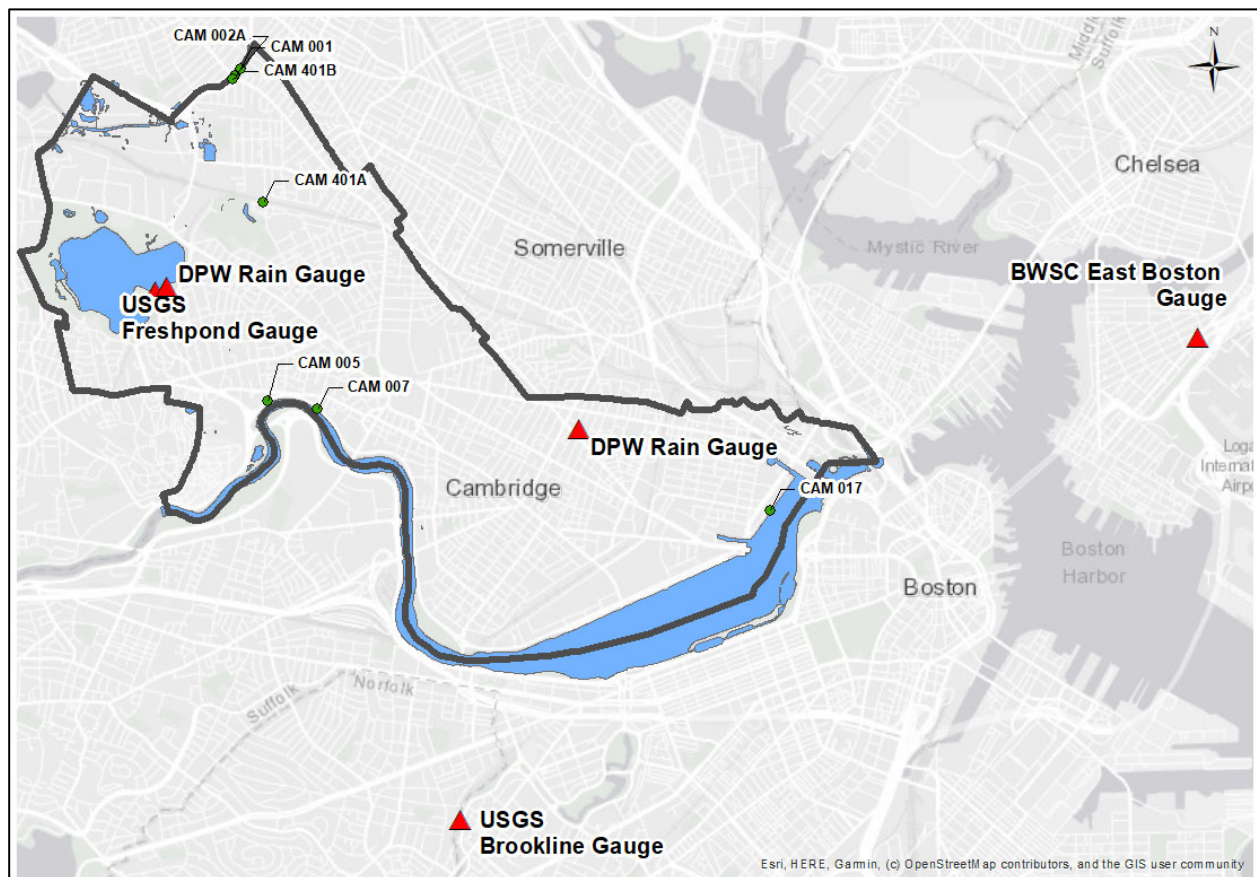
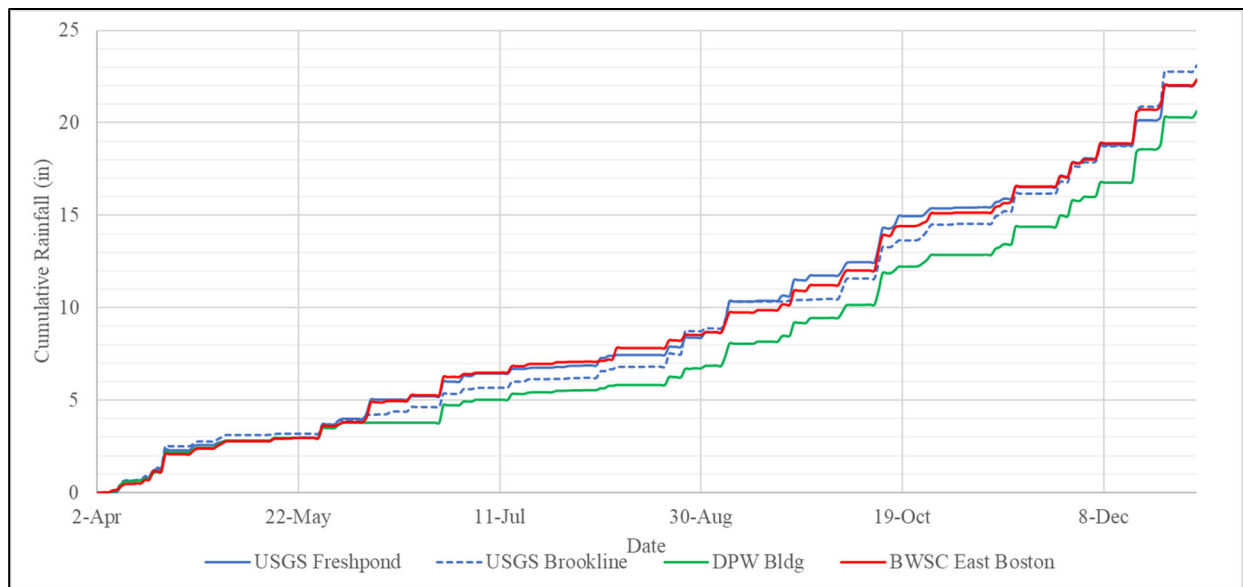

Figure 5 shows the cumulative rainfall measured at the rain gauges analyzed. The data is only plotted for the months where all the sources were recording rainfall, i.e., April to December. The

total rainfall reported was similar at all locations, indicating a lower spatial variability in the annual precipitation data for 2022.

Figure 5 – April to December 2022 Rainfall from Gauges in and Around Cambridge



The Cambridge DPW gauge (hereon referred to as ‘DPW’) was used as the primary source of precipitation data, given its location in the center of the City and relative proximity to the CSO regulators in both the Alewife Brook and Charles River watersheds. This gauge, however, was removed over the winter months. Therefore, to create a continuous year-long rainfall dataset, missing data was filled in from the USGS gauge located at Freshpond. This USGS gauge has been observed to under-report precipitation during larger storms in previous reporting years though no such anomalies were observed in 2022. A composite dataset, herein referred to as ‘Hybrid’ was created by combining the observed precipitation data from the USGS Freshpond (January 1- March 31, 2022) and DPW (April 1- December 31, 2022) gauges. This Hybrid time series was validated by comparing storm characteristics to the observed data from all the other sources mentioned earlier in this section. Additionally, comparison was also made to the Typical Year rainfall to assess any similarities or differences in the rainfall distribution and patterns. The findings from these analyses are presented further in this section.

It should be noted that the City replaced the rain gauges at DPW and the Water Department with heated gauges that will not be taken out of service in future winter periods.

Figure 6 shows the MWRA Typical Year rainfall plotted alongside the rainfall recorded in the Hybrid timeseries and at Freshpond in 2022.

Figure 6 – Typical Year Rainfall Versus 2022 Rainfall

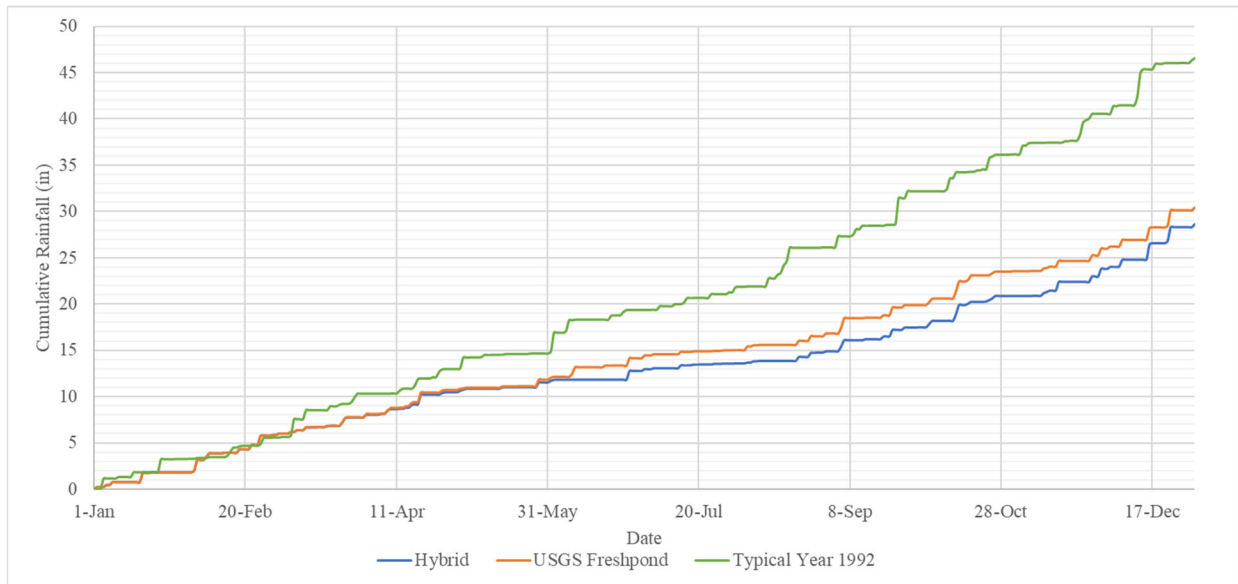

According to the Northeast Regional Climate Center the total observed precipitation in 2022 was about 28 inches, which is approximately 40% lower than the normal annual precipitation for the city and the total rainfall in the MWRA Typical Year. The northeast region of Massachusetts was classified under a ‘Level 2-Significant Drought’ category (through October 7, 2022) per the Massachusetts Drought Status monitoring report.

Table 3 and **Table 4** present a comparison of storm frequency and rainfall amounts within various ranges for 2022 compared to the MWRA Typical Year. The number of storms was counted assuming an inter-event time greater than or equal to twelve hours. The 2022 rainfall series overall recorded fewer storms than the Typical Year.

No storms with a total depth of 2.0 inches or more were observed in 2022. Generally, these storms account for a majority of the observed CSO spill volume during a reporting year. The typical year series has five storms totaling 13.87 inches in this range.

The Hybrid series had seven storms in the 1.0-to-2.0-inch range, with a total rainfall of 10.13 inches, compared to nine storms totaling 12.22 inches for the Typical Year series in the same range. The storms in these highest two ranges account for a majority of the variance in the total annual depth of precipitation between the Typical Year and observed time series. Similarly, in the 0.5-to-1.0-inch range, the Typical Year had five more events than the Hybrid series. The number of typical year storms in the 0.25-to-0.5-inch range match those observed in the Hybrid series. The Typical Year records more storms with depths less than 0.25 inches when compared to the hybrid series.

Table 3 – Frequency of Rainfall Events per Storm Depth Range

Rainfall Series	Total Rainfall (inches)	Total Number of Storms	Number of Storms by Depth				
			<0.25 inches	0.25 to 0.50 inches	0.5 to 1.0 inches	1.0 to 2.0 inches	>=2.0 inches
Typical Year	46.83	94	49	15	16	9	5
DPW ¹	20.90	62	36	12	9	5	0
Hybrid ²	28.29	72	39	15	11	7	0
Fresh Pond	30.43	81	41	20	13	7	0

1. DPW gauge was operational between 4/1/2022 to 12/31/2022
2. Hybrid time series is a combination of DPW and Freshpond rainfall

Table 4 – Annual Rainfall Depth Distribution per Storm Depth Range

Rainfall Series	Total Rainfall (inches)	Total Number of Storms	Total Rainfall Amount for Depth Range				
			Depth <0.25 inches	Depth 0.25 to 0.50 inches	Depth 0.5 to 1.0 inches	Depth 1.0 to 2.0 inches	Depth >=2.0 inches
Typical Year	46.83	94	3.45	5.86	11.43	12.22	13.87
DPW ¹	20.90	62	2.77	4.06	6.60	7.47	0.00
Hybrid ²	28.29	72	4.69	5.36	8.11	10.13	0.00
Fresh Pond	30.43	81	4.12	6.98	9.30	10.03	0.00

1. DPW gauge was operational between 4/1/2022 to 12/31/2022
2. Hybrid time series is a combination of DPW and Freshpond rainfall

Table 5 and **Figure 77** present the distribution of the total depth of storms by percentage. The MWRA Typical Year has about 30% of all recorded storms falling under the category of total rainfall over 2 inches. This is higher than the distribution of storm depths in the other categories. As noted earlier, no storms with depth greater than 2 inches were observed in 2022. The 2022 rainfall series have the highest distribution of storm depths in the 1 to 2 inches category.

Table 5 – Percent of Annual Rainfall Depth per Storm Depth Range

Rainfall Series	Total Rainfall (inches)	Total Number of Storms	Depth of Storms by Percentage				
			<0.25 inches	0.25 to 0.50 inches	0.5 to 1.0 inches	1.0 to 2.0 inches	>=2.0 inches
Typical Year	46.83	94	7.37%	12.51%	24.41%	26.09%	29.62%
DPW ¹	20.90	62	13.25%	19.43%	31.58%	35.74%	0.00%
Hybrid ²	28.29	72	16.58%	18.95%	28.67%	35.81%	0.00%
Fresh Pond	30.43	81	13.54%	22.94%	30.56%	32.96%	0.00%

1. DPW gauge was operational between 4/1/2022 to 12/31/2022
 2. Hybrid time series is a combination of DPW and Freshpond rainfall

Figure 7 – Frequency Comparison of Total Rainfall Depth Distribution by Percentage

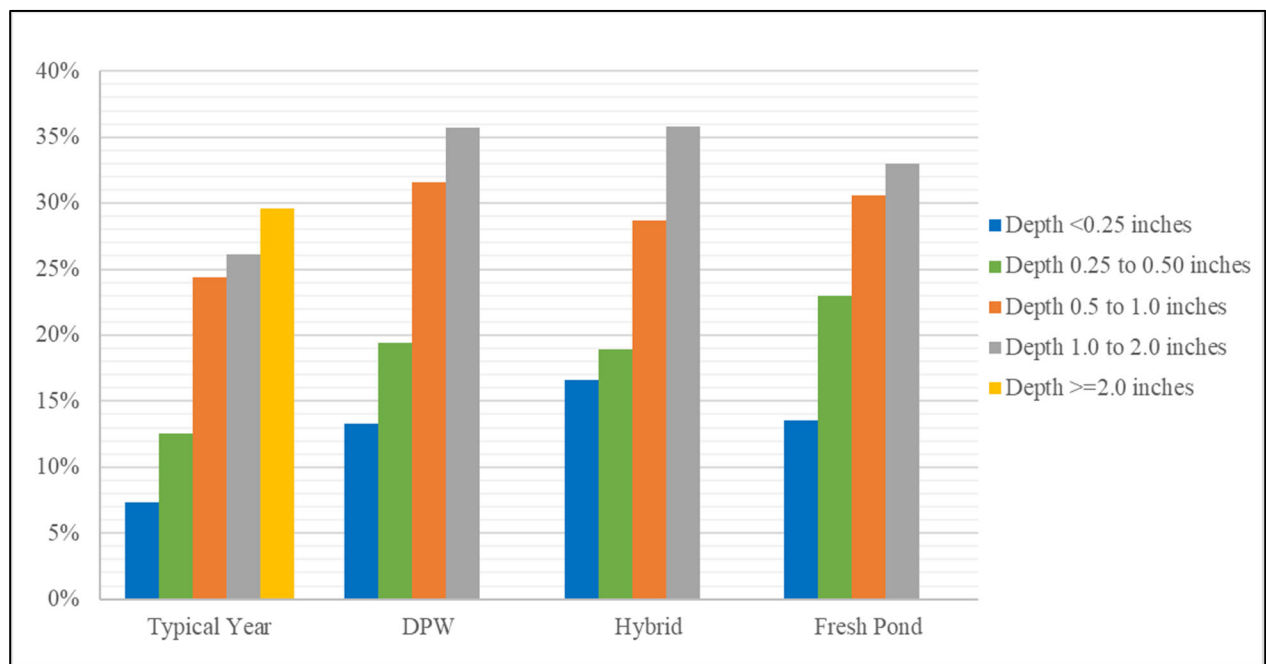

In addition to overall rainfall totals, CSO performance is also a function of storm intensity. **Table 6** presents the distribution of storms by peak intensity for 2022 and for the MWRA Typical Year.

Table 6 – Number of Storm Events at Selected Ranges of Peak Intensity

Rainfall Series	No. of Storms	Total Rainfall	Number of Storms by Peak Intensity				
			0.01 to 0.10 in/hr	0.10 to 0.25 in/hr	0.25 to 0.50 in/hr	0.50 to 1.0 in/hr	> 1.0 in/hr
Typical Year	94	46.83	42	26	12	9	5
DPW ¹	62	20.90	22	22	13	4	1
Hybrid ²	72	28.29	0	56	11	4	1
Fresh Pond	81	30.43	24	25	21	10	1
1. DPW gauge was operational between 4/1/2022 to 12/31/2022 2. Hybrid time series is a combination of DPW and Freshpond rainfall							

Table 7 presents the average and peak intensities for storms greater than 1 inch in depth. The 2022 Hybrid series includes just seven events in this category, compared to fourteen seen in the MWRA Typical Year.

Table 8 presents the same metrics for storm events with a peak intensity greater than 0.45 in/hr. The 2022 Hybrid series has nine events with peak intensity greater than 0.45 in/hr. Eight less compared to the seventeen seen in the MWRA Typical Year. The highest peak intensity observed in the Hybrid series is 1.08 in/hr during the August 26, 2022 event. The Typical Year has four events that exceed this peak intensity- May 2, August 11, September 9 and October 23. Consequently, this indicates less likelihood of larger CSO spills that tend to occur as a response to larger, more intense storm events.

Table 7 – Comparison of Storms with More Than 1 inch of Rainfall, Typical Year vs 2022

Rainfall Series	No. of Storms	Date	Duration (h)	Total Rainfall (in)	Peak Int (in/h)
Typical Year	14	12/11/1992	49.50	3.89	0.25
		8/15/1992	70.75	2.91	0.80
		9/22/1992	22.00	2.79	0.65
		5/31/1992	29.25	2.24	0.48
		10/9/1992	64.25	2.04	0.72
		11/21/1992	44.25	1.93	0.36
		3/6/1992	34.00	1.89	0.22
		1/23/1992	26.00	1.38	0.40
		6/5/1992	17.25	1.34	1.00
		9/3/1992	12.25	1.19	0.68
		10/23/1992	3.00	1.18	1.08
		1/4/1992	20.75	1.15	0.48
		5/2/1992	5.50	1.14	1.32
		4/16/1992	30.00	1.02	0.28
Hybrid	7	12/16/2022	24.67	1.92	0.24
		12/22/2022	19.00	1.84	0.36
		10/13/2022	16.67	1.72	0.60
		9/5/2022	28.67	1.48	0.12
		4/19/2022	4.00	1.08	0.48
		2/3/2022	21.75	1.05	0.24
		11/16/2022	9.00	1.04	0.36

Table 8 – Comparison of Storms with Peak Intensities Greater than 0.45 in/hr

Rainfall Series	No. of Storms	Date	Duration (hours)	Peak Int (in/h)	Total Rainfall (in)
Typical Year	17	9/9/1992	0.50	1.72	0.57
		5/2/1992	5.50	1.32	1.14
		8/11/1992	10.50	1.24	0.87
		10/23/1992	3.00	1.08	1.18
		6/5/1992	17.25	1.00	1.34
		7/11/1992	0.50	0.84	0.22
		8/15/1992	70.75	0.80	2.91
		10/9/1992	64.25	0.72	2.04
		9/3/1992	12.25	0.68	1.19
		7/31/1992	18.75	0.68	0.59
		9/22/1992	22.00	0.65	2.79
		7/29/1992	0.50	0.64	0.20
		6/20/1992	12.75	0.56	0.45
		1/14/1992	9.50	0.52	0.49
		5/31/1992	29.25	0.48	2.24
		1/4/1992	20.75	0.48	1.15
		3/11/1992	12.25	0.48	0.97
Hybrid	9	8/26/2022	2.00	1.08	0.48
		6/27/2022	7.33	0.72	0.92
		10/13/2022	16.67	0.60	1.72
		11/30/2022	4.33	0.60	0.84
		3/25/2022	3.50	0.60	0.48
		4/19/2022	4.00	0.48	1.08
		5/28/2022	14.33	0.48	0.60
		7/14/2022	1.33	0.48	0.28
		9/19/2022	1.00	0.48	0.28

2022 Rainfall Summary

2022 had about 28 inches of rainfall, which is significantly less than normal when compared to other precipitation years. Furthermore, several of these observed storm events were of lower intensity, as discussed previously in this section. The observed precipitation in the region during the summer months (July-Sept) in 2022 was around 50 - 75% of the normal average precipitation, as shown in **Figure 88**.

Figure 8 – Percent of Normal Precipitation in Massachusetts (July-Sept 2022)

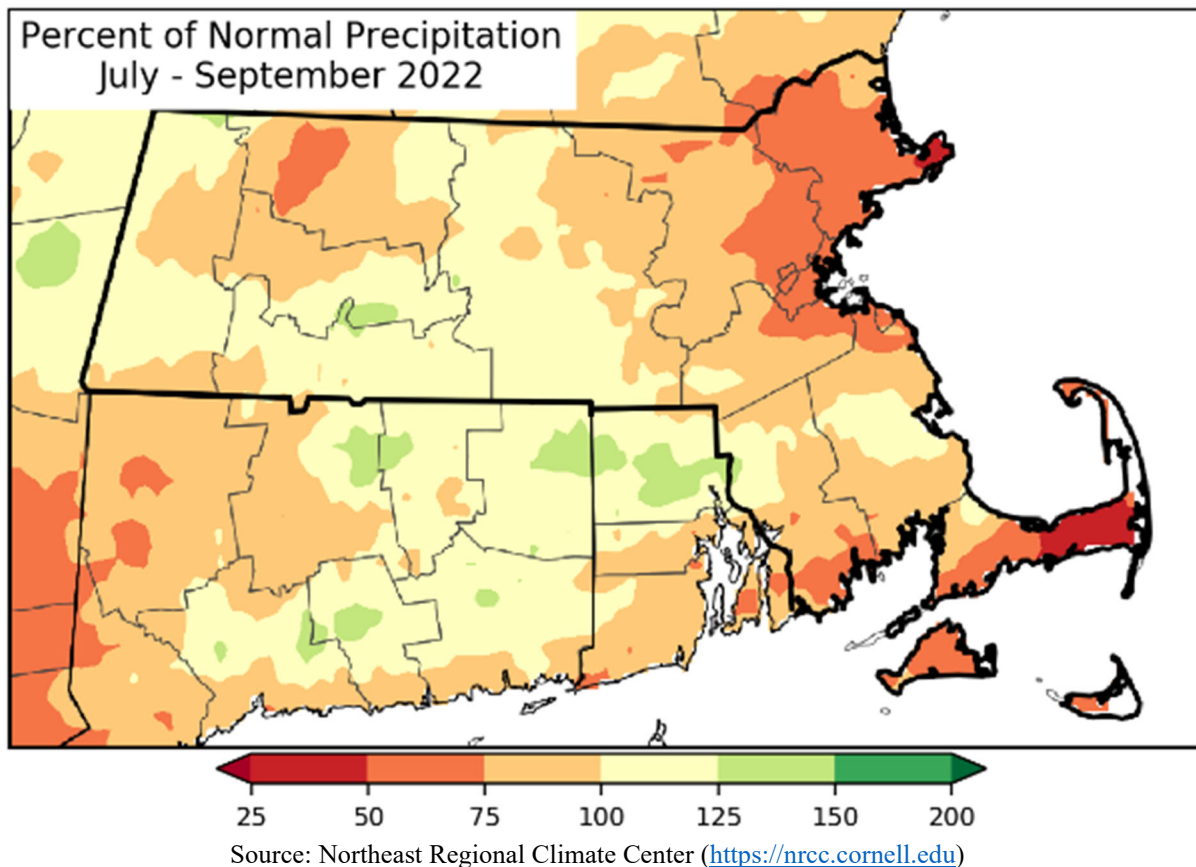

Figure 99 shows the cumulative rainfall for July through September 2022 plotted alongside the Typical Year. The total rainfall observed in this period in 2022 was 4.71 inches, which is approximately 8 inches lower than 12.8 inches during the same months in the Typical Year. During a year with normal precipitation, several large and high-intensity storm events are observed during these summer months, resulting in a majority of the CSO spill volume for the reporting year. As discussed previously in this section, no storms over 2 inches were observed in 2022. It is also worth noting that the August 26, 2022 event, which recorded the highest peak intensity for storms in 2022 had a total rainfall depth of only 0.48 inches. Consequently, both the number and total volume of CSO spills in 2022 can be anticipated to be significantly lower in comparison to the average precipitation year, and the Typical Year.

Figure 9 – Cumulative Rainfall, July-September 2022

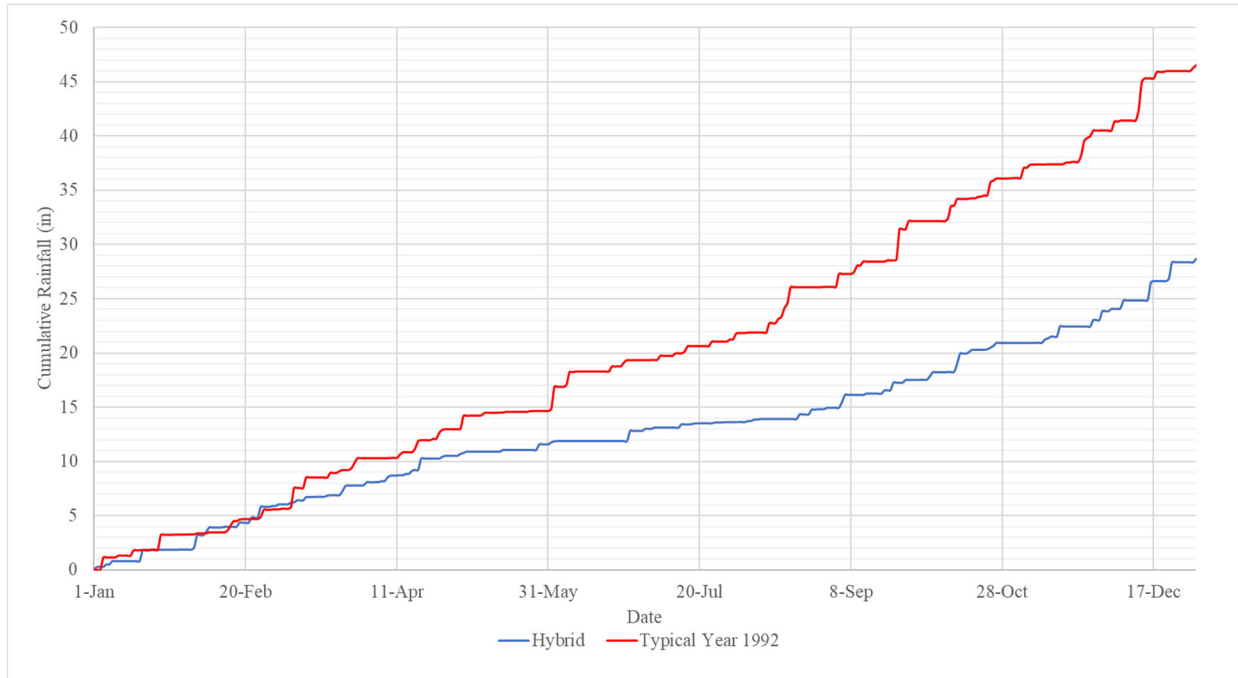
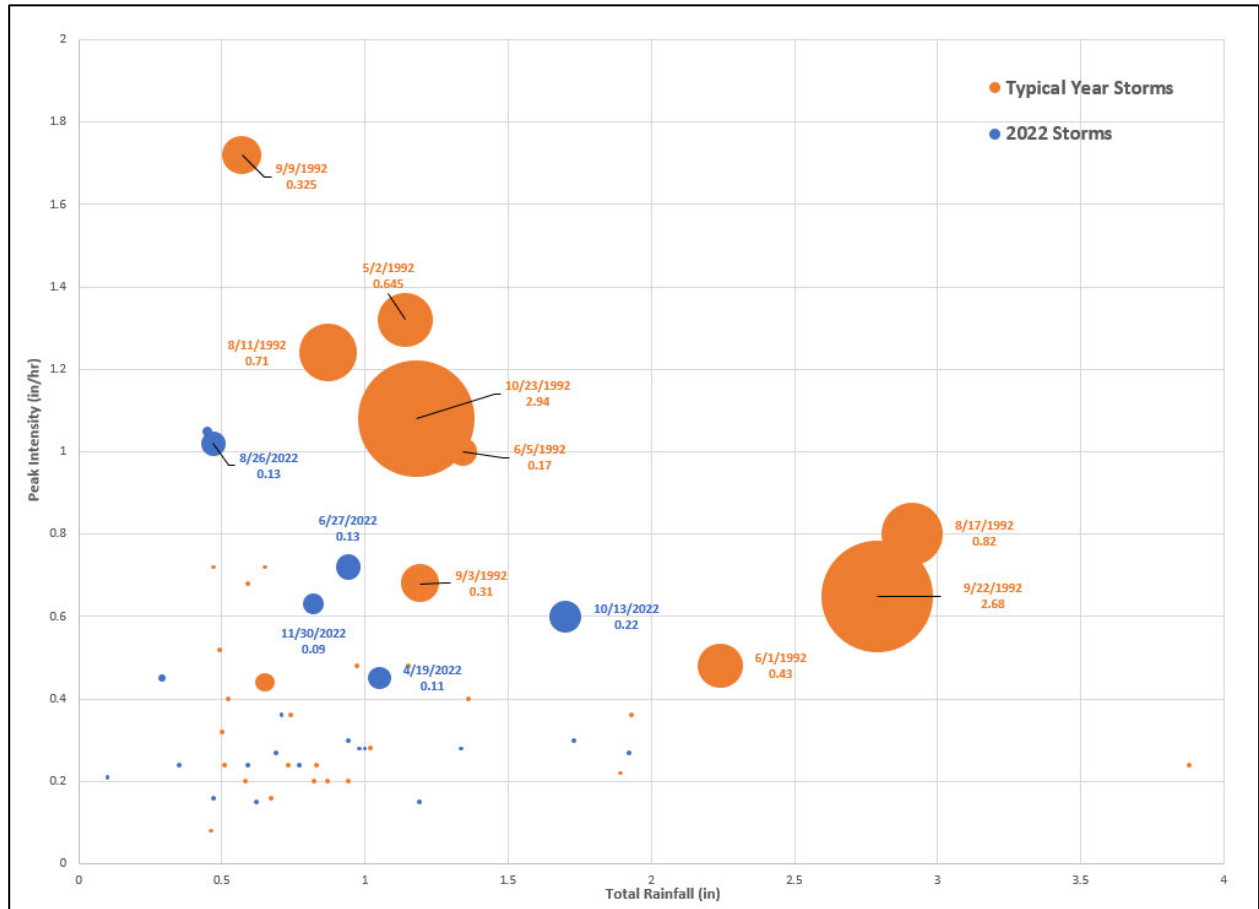

Figure 1010 shows the Typical Year and 2022 storm events plotted on an intensity-depth scatter chart for all storms with a total depth above 0.45 inches. The size of the bubbles for individual events are scaled to the total CSO spill volume. All storm events with a CSO occurrence are labelled with the date and the corresponding CSO spill volume across all regulators in the system—both in the Charles River and the Alewife Brook. The scatter chart shows that the storm events recorded in 2022 are overall smaller than the Typical Year storms, both in terms of total rainfall depth and intensity. Typically, the system in Cambridge encounters capacity constraints that lead to CSO spills during storms larger than 1 inch combined with peak intensities over 1 in/hr. Additionally, storms that are clear outliers in terms of peak intensity (such as the September 9 event in the Typical Year) or total depth (such as the September 22 event in the Typical Year) result in CSO discharges. The storms recorded in the 2022 reporting year do not fall in either of these categories and consequently result in CSO counts and discharge volumes that are considerably lower than that observed in the Typical Year. The events occurring on April 19, June 27, August 26 and October 13, 2022, account for 0.59 MG of discharge volume which accounts for over 80% of the total annual discharge volume in the 2022 reporting year. All other CSO occurrences have individual spill volumes under 10,000 gallons.

Figure 10 – Intensity Versus Depth Scatter Chart- Typical Year and 2022 Storm Events



Note: Only CSO spills with a volume > 0.01 MG are shown in figure

3.3 Summary of 2022 CSO Activations

This section provides an overview of the total CSO spill counts and the corresponding spill volumes for all CSO regulators in 2022. The 2022 CSO spill counts and volumes are shown in **Table 9**, with a comparison to those simulated for the MWRA Typical Year. Model simulation results are based on the Unified Model build as of March 2023. The City's Unified Model continues to be updated with on-going co-ordination with the MWRA and the City of Somerville. These results are hence subject to change.

The CSO spill occurrences and volumes presented herein are the result of detailed analyses of flow and level metering data from multiple sources, river stage data, MWRA operating data, feedback from City maintenance staff on potential metering discrepancies, and results of hydraulic modeling completed after the wet-weather events took place. These occurrences and volumes often differ from what is reported on the City's website. From January 1st to July 6th, 2022, the City used preliminary monitoring data to verify spill occurrences and estimate spill volumes within 5-days of an overflow occurring. After July 6th, the 3-year average spill volume for a site was automatically posted to the City's website when SCADA data indicated a spill had occurred. The occurrences and volumes were then corrected with updated monitoring data. A comparison of spill volumes reported on the City's website to the volumes listed in this report are included in Appendix IV.

Table 9 – 2022 CSO Results Summary

Outfall	2022 Metered CSO Spills ¹	Metered Volume (MG)	2022 Modeled CSO Spills	City Modeled TY Results 2022 System Conditions		LTCP Requirements	
				Activations	Volume (MG)	Activations	Volume (MG)
ALEWIFE BROOK							
CAM 001	0	0.00	0	0	0.00	5	0.19
CAM 002	0	0.00	0	0	0.00	4	0.69
CAM 401A	10	0.47	4	9	6.65	5	1.61
CAM 401B	0	0.00	0	2	0.12	7	2.15
Total	10	0.47	4	11	6.77	21	4.64
CHARLES RIVER							
CAM 005	4	0.16	0	5	0.53	3	0.84
CAM 007	0	0.00	0	1	0.02	1	0.03
CAM 017	0	0.00	0	0	0.00	1	0.45
Total	4	0.16	0	6	0.55	5	1.32

¹Metered spills include those with a volume less than 0.01 MG. Modeled results do not include spills with a volume less than 0.01 MG.

As discussed in Section 3.2, 2022 had significantly less rainfall compared to the Typical Year. Additionally, there were fewer high-intensity storms and no storms with a total rainfall over 2 inches. As a result, it is not unexpected that the CSO spill count and volume in 2022 was significantly lower than the Typical Year and will likely meet the LTCP goals. It is important to consider the rainfall characteristics of 2022 while observing the variance in the CSO results.

3.3.1 Alewife Brook CSO Results

Three of the four active CSO outfalls along Alewife Brook had no spills in 2022. The fourth location, CAM 401A, spilled a total of ten times in 2022 resulting in 0.47 MG of CSO volume.

CAM 001

The City's metering data and model results indicated no CSO spills at CAM 001 in 2022.

Model results indicate the MWRA Typical Year would generate no spills. The LTCP threshold for CAM 001 are five spills with a total volume of 0.19 MG, so the 2022 results indicate CAM 001 is in compliance with the LTCP.

CAM 002

The City's metering data and model results indicated no CSO spills at CAM 002 in 2022.

Model results also indicate the MWRA Typical Year would not generate any spills, which is less than the LTCP threshold of four spills and 0.69 MG. Therefore, CAM 002 is in compliance with the LTCP.

CAM 401A

Flow monitoring data indicated ten CSO spills at CAM 401A with a total discharge volume of 0.47 MG.

Model results for 2022 rainfall indicated four CSO spills at CAM 401A with a total volume of 0.22 MG.

The discrepancy between the modeled and metered CSO results is largely accounted for by seven minor, short duration spills with individual discharge volumes below 10,000 gallons. As discussed in Section 3.1.2, the modeled level in the regulator correlates well with flow monitoring data and the City will continue to monitor the correlation between modeled and metered results, particularly during larger storms that were not seen in the 2022 reporting year.

Model results indicate the MWRA Typical Year would result in eleven spills for a total volume of 6.67 MG. This exceeds the LTCP threshold of five spills and 1.61 MG of discharge volume.

CAM 401B

The City's metering data and model results indicated no CSO spills at CAM 401B in 2022.

Model results indicate the MWRA Typical Year would result in two spills for a total volume of 0.12 MG. This is much lower than the volume reported previously in the 2021 Annual CSO report and is a result of extensive model recalibration in the CAM 401B contributing areas that was completed in 2022. The CSO results at CAM 401B are in compliance with the LTCP threshold of seven spills and 2.15 MG of CSO volume.

3.3.2 Charles River CSO Results

Two of the three active CSO outfalls on the Charles River had no spills in 2022. The third location, CAM 005, spilled a total of four times in 2022 resulting in 0.16 MG of CSO volume.

CAM 005

Flow monitoring data indicated four CSO spills at CAM 005 in 2022 with a total volume of 0.16 MG.

Model results indicated no spills at CAM 005 in 2022.

The four metered spills were all observed to be short duration with relatively low discharge volumes. While modeled levels at the regulator were observed to rise corresponding to the metered levels, the modeled levels never exceeded the overflow weir elevation.. In addition to the hydraulics of the regulator, it is possible that minor spill occurrences were a result of marginally higher rainfall intensity in the immediate vicinity and/or variation in flow levels in the MWRA interceptor.

Model results also indicate the MWRA Typical Year would result in five spills with a total volume of 0.53 MG. This exceeds the LTCP threshold of three spills but is below the required spill volume of 0.84 MG.

CAM 007

The City's metering data and model results indicated no CSO spills at CAM 007 in 2022.

Model results indicate the MWRA Typical Year would result in one spill at CAM 007 with a volume of 0.02MG, which meets the LTCP threshold.

CAM 017

The City's metering data and model results indicated no CSO spills at CAM 017 in 2022.

Model results indicate the MWRA Typical Year would result in no spills at CAM 017, which meets the LTCP requirements.

3.4 Coordination with MWRA

The City will continue to coordinate with MWRA to routinely exchange information on changes in the regional and City collection systems so that both parties are informed of existing conditions in infrastructure and simulation in hydraulic models. MWRA metering data, where available, will continue to be used to supplement City metering data for hydraulic model validation. Where variability between the City and MWRA meters are observed, the two entities will continue to coordinate and validate the results.

Pump operations and system optimization at key MWRA facilities is critical to the performance of multiple City CSO outfalls. The actual operation of the MWRA CSO Facilities can vary greatly in response to an event and these variations can impact spill count and volumes at Cambridge CSO outfalls.

The City of Cambridge, City of Somerville, and MWRA are each developing individual Updated CSO Control Plans to build upon the current MWRA CSO Long-Term Control Plan. While the City is developing an Updated CSO Control Plan focused on the CSO outfalls that the City owns and operates, collaboration with MWRA and the City of Somerville is critical to each plans success. This collaboration will produce a unified hydraulic model of the three collection systems to evaluate local and regional CSO reduction alternatives and measures, an updated future looking Typical Year, and facilitate discussion on interconnected portions of each system.

4. Status of CSO Abatement Projects

4.1 Project Updates

The City of Cambridge continues to implement abatement projects to remove stormwater from its combined sewer system, however continued sewer separation is dependent upon cost effective strategies to manage water quality from stormwater discharges, in particular from Phosphorous. This may include expanding areas that are partially separated, in which a portion of the stormwater continues to discharge to the sewer system for treatment. As an example, the partial separation of the service areas tributary to the Endicott and Talbot outfalls has been shown to reduce CSO spill volumes at MWRA's Cottage Farm CSO Facility while allowing the capture and treatment of over 85 percent of the urban stormwater runoff from these areas.

5. Modifications to Nine Minimum Controls Plan

The Nine Minimum Controls Plan (NMCP) was substantially updated in its entirety and submitted together with the first annual report (April 2009). The plan provides a summary of the evaluations undertaken to address each control measure since the original plan was developed in 1997.

Enhancements were made to the NMCP to meet the minimum implementation levels stipulated in the permit. These Public Notification requirements were further updated to reflect changes in current permit requirements. These enhancements were summarized in **Table 10**.

Table 10 – Enhancements to the Nine Minimum Controls Plan

Control Measure	Proposed Enhancement
1. Proper Operation and Regular Maintenance Programs	<ul style="list-style-type: none">• Adherence to detailed "Good Housekeeping Manual" to provide specific guidance and protocols for major DPW tasks• Development and utilization of routine inspection forms and work order system• Update of infrastructure assets and nomenclature• Update of DPW organizational structure and budget figures
2. Maximization of Storage in the Collection System	<ul style="list-style-type: none">• Update database of existing key regulator components• Establish procedure for documentation of purpose and benefits to any future modifications to existing structures
3. Review and Modification of Pretreatment Requirements	<ul style="list-style-type: none">• Adherence to recently developed Wastewater and Stormwater Use Regulations, inspection frequencies and enforcement activities

Control Measure	Proposed Enhancement
4. Maximization of Flow to POTW	<ul style="list-style-type: none"> • Maintain updated inventory of CSO capital projects; • Continue funding for annual cleaning and remedial repair and reconstruction contracts
5. Prohibition Elimination of Dry Weather Discharges	<ul style="list-style-type: none"> • The City is unaware of any dry weather discharges from CSO outfalls
6. Control of Solid and Floatable Materials in CSOs	<ul style="list-style-type: none"> • Continue to maintain devices that control discharge of floatables at all CSO outfalls. • Continue to require compliance with new City Wastewater and Stormwater Use Regulations
7. Pollution Prevention Programs to Reduce Contaminants in CSOs	<ul style="list-style-type: none"> • Adherence to "Good Housekeeping Manual" guidance and protocols to reduce the City's contribution of contaminants to stormwater; • Adherence to City of Cambridge Integrated Pest Management plan to reduce contributions of pesticides, fungicides, herbicides and fertilizer to run-off; • Continue aggressive recycling, street sweeping and household hazardous waste collections and management • Continue with public education and outreach activities • Continue to require compliance with new City Wastewater and Stormwater Use Regulations
8. Public Notification	<ul style="list-style-type: none"> • Public Notification procedure updated per variance requirements beginning in 2021 and in 2022 to comply with 314 CMR 16.0
9. Metering to Characterize CSO Impacts and Efficacy of CSO Controls	<ul style="list-style-type: none"> • On a regulator site-specific basis, use revised weir equations and parameters and/or hydraulic models and analysis to estimate effluent volumes released during CSO events

APPENDIX I
2022 PRECIPITATION DATA

2022 Daily Rainfall Data
Hybrid Rainfall (Cambridge DPW Gauge and USGS Freshpond Gauge)

Date	Rainfall (in)	Peak Intensity (in/hr)	Average Intensity (in/hr)
1/1/2022	0.05	0.08	0.00
1/2/2022	0.19	0.16	0.01
1/3/2022	0.00	0.00	0.00
1/4/2022	0.00	0.00	0.00
1/5/2022	0.22	0.28	0.01
1/6/2022	0.00	0.00	0.00
1/7/2022	0.31	0.12	0.01
1/8/2022	0.00	0.00	0.00
1/9/2022	0.00	0.00	0.00
1/10/2022	0.00	0.00	0.00
1/11/2022	0.00	0.00	0.00
1/12/2022	0.00	0.00	0.00
1/13/2022	0.00	0.00	0.00
1/14/2022	0.00	0.00	0.00
1/15/2022	0.00	0.00	0.00
1/16/2022	0.00	0.00	0.00
1/17/2022	0.98	0.28	0.04
1/18/2022	0.00	0.00	0.00
1/19/2022	0.00	0.00	0.00
1/20/2022	0.06	0.04	0.00
1/21/2022	0.00	0.00	0.00
1/22/2022	0.00	0.00	0.00
1/23/2022	0.00	0.00	0.00
1/24/2022	0.00	0.00	0.00
1/25/2022	0.00	0.00	0.00
1/26/2022	0.00	0.00	0.00
1/27/2022	0.00	0.00	0.00
1/28/2022	0.00	0.00	0.00
1/29/2022	0.02	0.04	0.00
1/30/2022	0.00	0.00	0.00
1/31/2022	0.00	0.00	0.00
TOTAL	1.83		

2022 Daily Rainfall Data
Hybrid Rainfall (Cambridge DPW Gauge and USGS Freshpond Gauge)

Date	Rainfall (in)	Peak Intensity (in/hr)	Average Intensity (in/hr)
2/1/2022	0.00	0.00	0.00
2/2/2022	0.00	0.00	0.00
2/3/2022	0.20	0.16	0.01
2/4/2022	1.14	0.28	0.05
2/5/2022	0.00	0.00	0.00
2/6/2022	0.00	0.00	0.00
2/7/2022	0.31	0.36	0.01
2/8/2022	0.40	0.24	0.02
2/9/2022	0.00	0.00	0.00
2/10/2022	0.00	0.00	0.00
2/11/2022	0.00	0.00	0.00
2/12/2022	0.00	0.00	0.00
2/13/2022	0.06	0.04	0.00
2/14/2022	0.00	0.00	0.00
2/15/2022	0.00	0.00	0.00
2/16/2022	0.00	0.00	0.00
2/17/2022	0.00	0.00	0.00
2/18/2022	0.38	0.16	0.02
2/19/2022	0.00	0.00	0.00
2/20/2022	0.00	0.00	0.00
2/21/2022	0.00	0.00	0.00
2/22/2022	0.47	0.16	0.02
2/23/2022	0.00	0.00	0.00
2/24/2022	0.00	0.00	0.00
2/25/2022	1.00	0.28	0.04
2/26/2022	0.00	0.00	0.00
2/27/2022	0.00	0.00	0.00
2/28/2022	0.00	0.00	0.00
TOTAL	3.95		

2022 Daily Rainfall Data
Hybrid Rainfall (Cambridge DPW Gauge and USGS Freshpond Gauge)

Date	Rainfall (in)	Peak Intensity (in/hr)	Average Intensity (in/hr)
3/1/2022	0.08	0.08	0.00
3/2/2022	0.00	0.00	0.00
3/3/2022	0.15	0.12	0.01
3/4/2022	0.00	0.00	0.00
3/5/2022	0.00	0.00	0.00
3/6/2022	0.00	0.00	0.00
3/7/2022	0.17	0.24	0.01
3/8/2022	0.00	0.00	0.00
3/9/2022	0.19	0.08	0.01
3/10/2022	0.00	0.00	0.00
3/11/2022	0.00	0.00	0.00
3/12/2022	0.31	0.32	0.01
3/13/2022	0.00	0.00	0.00
3/14/2022	0.01	0.04	0.00
3/15/2022	0.00	0.00	0.00
3/16/2022	0.02	0.08	0.00
3/17/2022	0.00	0.00	0.00
3/18/2022	0.00	0.00	0.00
3/19/2022	0.11	0.16	0.00
3/20/2022	0.03	0.16	0.00
3/21/2022	0.00	0.00	0.00
3/22/2022	0.00	0.00	0.00
3/23/2022	0.00	0.00	0.00
3/24/2022	0.38	0.16	0.02
3/25/2022	0.47	0.60	0.02
3/26/2022	0.05	0.08	0.00
3/27/2022	0.00	0.00	0.00
3/28/2022	0.00	0.00	0.00
3/29/2022	0.00	0.00	0.00
3/30/2022	0.00	0.00	0.00
3/31/2022	0.02	0.08	0.00
TOTAL	1.99		

2022 Daily Rainfall Data
Hybrid Rainfall (Cambridge DPW Gauge and USGS Freshpond Gauge)

Date	Rainfall (in)	Peak Intensity (in/hr)	Average Intensity (in/hr)
4/1/2022	0.27	0.24	0.01
4/2/2022	0.00	0.00	0.00
4/3/2022	0.00	0.00	0.00
4/4/2022	0.02	0.03	0.00
4/5/2022	0.00	0.00	0.00
4/6/2022	0.09	0.06	0.00
4/7/2022	0.02	0.03	0.00
4/8/2022	0.35	0.33	0.01
4/9/2022	0.14	0.27	0.01
4/10/2022	0.00	0.00	0.00
4/11/2022	0.00	0.00	0.00
4/12/2022	0.04	0.06	0.00
4/13/2022	0.00	0.00	0.00
4/14/2022	0.11	0.12	0.00
4/15/2022	0.02	0.09	0.00
4/16/2022	0.28	0.18	0.01
4/17/2022	0.08	0.12	0.00
4/18/2022	0.00	0.00	0.00
4/19/2022	1.05	0.45	0.04
4/20/2022	0.00	0.00	0.00
4/21/2022	0.00	0.00	0.00
4/22/2022	0.00	0.00	0.00
4/23/2022	0.00	0.00	0.00
4/24/2022	0.00	0.00	0.00
4/25/2022	0.00	0.00	0.00
4/26/2022	0.17	0.06	0.01
4/27/2022	0.09	0.06	0.00
4/28/2022	0.00	0.00	0.00
4/29/2022	0.00	0.00	0.00
4/30/2022	0.00	0.00	0.00
TOTAL	2.72		

2022 Daily Rainfall Data
Hybrid Rainfall (Cambridge DPW Gauge and USGS Freshpond Gauge)

Date	Rainfall (in)	Peak Intensity (in/hr)	Average Intensity (in/hr)
5/1/2022	0.00	0.00	0.00
5/2/2022	0.17	0.33	0.01
5/3/2022	0.10	0.06	0.00
5/4/2022	0.10	0.09	0.00
5/5/2022	0.00	0.00	0.00
5/6/2022	0.00	0.00	0.00
5/7/2022	0.00	0.00	0.00
5/8/2022	0.00	0.00	0.00
5/9/2022	0.00	0.00	0.00
5/10/2022	0.00	0.00	0.00
5/11/2022	0.00	0.00	0.00
5/12/2022	0.00	0.00	0.00
5/13/2022	0.00	0.00	0.00
5/14/2022	0.00	0.00	0.00
5/15/2022	0.01	0.03	0.00
5/16/2022	0.15	0.18	0.01
5/17/2022	0.00	0.00	0.00
5/18/2022	0.00	0.00	0.00
5/19/2022	0.00	0.00	0.00
5/20/2022	0.00	0.00	0.00
5/21/2022	0.00	0.00	0.00
5/22/2022	0.00	0.00	0.00
5/23/2022	0.00	0.00	0.00
5/24/2022	0.00	0.00	0.00
5/25/2022	0.00	0.00	0.00
5/26/2022	0.00	0.00	0.00
5/27/2022	0.00	0.00	0.00
5/28/2022	0.52	0.51	0.02
5/29/2022	0.00	0.00	0.00
5/30/2022	0.00	0.00	0.00
5/31/2022	0.01	0.03	0.00
TOTAL	1.06		

2022 Daily Rainfall Data
Hybrid Rainfall (Cambridge DPW Gauge and USGS Freshpond Gauge)

Date	Rainfall (in)	Peak Intensity (in/hr)	Average Intensity (in/hr)
6/1/2022	0.18	0.15	0.01
6/2/2022	0.10	0.12	0.00
6/3/2022	0.01	0.03	0.00
6/4/2022	0.00	0.00	0.00
6/5/2022	0.00	0.00	0.00
6/6/2022	0.00	0.00	0.00
6/7/2022	0.00	0.00	0.00
6/8/2022	0.00	0.00	0.00
6/9/2022	0.00	0.00	0.00
6/10/2022	0.00	0.00	0.00
6/11/2022	0.00	0.00	0.00
6/12/2022	0.00	0.00	0.00
6/13/2022	0.00	0.00	0.00
6/14/2022	0.00	0.00	0.00
6/15/2022	0.00	0.00	0.00
6/16/2022	0.00	0.00	0.00
6/17/2022	0.00	0.00	0.00
6/18/2022	0.00	0.00	0.00
6/19/2022	0.00	0.00	0.00
6/20/2022	0.00	0.00	0.00
6/21/2022	0.00	0.00	0.00
6/22/2022	0.00	0.00	0.00
6/23/2022	0.00	0.00	0.00
6/24/2022	0.00	0.00	0.00
6/25/2022	0.00	0.00	0.00
6/26/2022	0.00	0.00	0.00
6/27/2022	0.94	0.72	0.04
6/28/2022	0.00	0.00	0.00
6/29/2022	0.00	0.00	0.00
6/30/2022	0.01	0.03	0.00
TOTAL	1.24		

2022 Daily Rainfall Data
Hybrid Rainfall (Cambridge DPW Gauge and USGS Freshpond Gauge)

Date	Rainfall (in)	Peak Intensity (in/hr)	Average Intensity (in/hr)
7/1/2022	0.00	0.00	0.00
7/2/2022	0.19	0.21	0.01
7/3/2022	0.00	0.00	0.00
7/4/2022	0.00	0.00	0.00
7/5/2022	0.10	0.12	0.00
7/6/2022	0.00	0.00	0.00
7/7/2022	0.00	0.00	0.00
7/8/2022	0.00	0.00	0.00
7/9/2022	0.00	0.00	0.00
7/10/2022	0.00	0.00	0.00
7/11/2022	0.00	0.00	0.00
7/12/2022	0.00	0.00	0.00
7/13/2022	0.00	0.00	0.00
7/14/2022	0.31	0.45	0.01
7/15/2022	0.00	0.00	0.00
7/16/2022	0.00	0.00	0.00
7/17/2022	0.00	0.00	0.00
7/18/2022	0.07	0.12	0.00
7/19/2022	0.02	0.06	0.00
7/20/2022	0.00	0.00	0.00
7/21/2022	0.00	0.00	0.00
7/22/2022	0.00	0.00	0.00
7/23/2022	0.00	0.00	0.00
7/24/2022	0.00	0.00	0.00
7/25/2022	0.08	0.18	0.00
7/26/2022	0.00	0.00	0.00
7/27/2022	0.00	0.00	0.00
7/28/2022	0.02	0.03	0.00
7/29/2022	0.00	0.00	0.00
7/30/2022	0.00	0.00	0.00
7/31/2022	0.00	0.00	0.00
TOTAL	0.79		

2022 Daily Rainfall Data
 Hybrid Rainfall (Cambridge DPW Gauge and USGS Freshpond Gauge)

Date	Rainfall (in)	Peak Intensity (in/hr)	Average Intensity (in/hr)
8/1/2022	0.02	0.03	0.00
8/2/2022	0.00	0.00	0.00
8/3/2022	0.00	0.00	0.00
8/4/2022	0.00	0.00	0.00
8/5/2022	0.10	0.21	0.00
8/6/2022	0.00	0.00	0.00
8/7/2022	0.13	0.27	0.01
8/8/2022	0.00	0.00	0.00
8/9/2022	0.05	0.06	0.00
8/10/2022	0.00	0.00	0.00
8/11/2022	0.00	0.00	0.00
8/12/2022	0.00	0.00	0.00
8/13/2022	0.00	0.00	0.00
8/14/2022	0.00	0.00	0.00
8/15/2022	0.00	0.00	0.00
8/16/2022	0.00	0.00	0.00
8/17/2022	0.00	0.00	0.00
8/18/2022	0.00	0.00	0.00
8/19/2022	0.00	0.00	0.00
8/20/2022	0.00	0.00	0.00
8/21/2022	0.00	0.00	0.00
8/22/2022	0.42	0.27	0.02
8/23/2022	0.00	0.00	0.00
8/24/2022	0.00	0.00	0.00
8/25/2022	0.00	0.00	0.00
8/26/2022	0.44	1.02	0.02
8/27/2022	0.00	0.00	0.00
8/28/2022	0.04	0.12	0.00
8/29/2022	0.00	0.00	0.00
8/30/2022	0.00	0.00	0.00
8/31/2022	0.13	0.06	0.01
TOTAL	1.33		

2022 Daily Rainfall Data
Hybrid Rainfall (Cambridge DPW Gauge and USGS Freshpond Gauge)

Date	Rainfall (in)	Peak Intensity (in/hr)	Average Intensity (in/hr)
9/1/2022	0.00	0.00	0.00
9/2/2022	0.01	0.03	0.00
9/3/2022	0.00	0.00	0.00
9/4/2022	0.00	0.00	0.00
9/5/2022	0.53	0.12	0.02
9/6/2022	0.66	0.15	0.03
9/7/2022	0.00	0.00	0.00
9/8/2022	0.00	0.00	0.00
9/9/2022	0.00	0.00	0.00
9/10/2022	0.00	0.00	0.00
9/11/2022	0.00	0.00	0.00
9/12/2022	0.00	0.00	0.00
9/13/2022	0.11	0.09	0.00
9/14/2022	0.00	0.00	0.00
9/15/2022	0.00	0.00	0.00
9/16/2022	0.00	0.00	0.00
9/17/2022	0.00	0.00	0.00
9/18/2022	0.00	0.00	0.00
9/19/2022	0.29	0.45	0.01
9/20/2022	0.02	0.06	0.00
9/21/2022	0.02	0.06	0.00
9/22/2022	0.69	0.27	0.03
9/23/2022	0.00	0.00	0.00
9/24/2022	0.00	0.00	0.00
9/25/2022	0.00	0.00	0.00
9/26/2022	0.25	0.21	0.01
9/27/2022	0.01	0.03	0.00
9/28/2022	0.00	0.00	0.00
9/29/2022	0.00	0.00	0.00
9/30/2022	0.00	0.00	0.00
TOTAL	2.58		

2022 Daily Rainfall Data
Hybrid Rainfall (Cambridge DPW Gauge and USGS Freshpond Gauge)

Date	Rainfall (in)	Peak Intensity (in/hr)	Average Intensity (in/hr)
10/1/2022	0.01	0.03	0.00
10/2/2022	0.00	0.00	0.00
10/3/2022	0.00	0.00	0.00
10/4/2022	0.32	0.15	0.01
10/5/2022	0.37	0.15	0.02
10/6/2022	0.02	0.06	0.00
10/7/2022	0.00	0.00	0.00
10/8/2022	0.00	0.00	0.00
10/9/2022	0.00	0.00	0.00
10/10/2022	0.01	0.03	0.00
10/11/2022	0.01	0.03	0.00
10/12/2022	0.00	0.00	0.00
10/13/2022	0.73	0.51	0.03
10/14/2022	0.97	0.60	0.04
10/15/2022	0.00	0.00	0.00
10/16/2022	0.00	0.00	0.00
10/17/2022	0.15	0.24	0.01
10/18/2022	0.20	0.09	0.01
10/19/2022	0.00	0.00	0.00
10/20/2022	0.00	0.00	0.00
10/21/2022	0.00	0.00	0.00
10/22/2022	0.00	0.00	0.00
10/23/2022	0.04	0.03	0.00
10/24/2022	0.15	0.18	0.01
10/25/2022	0.17	0.12	0.01
10/26/2022	0.27	0.15	0.01
10/27/2022	0.00	0.00	0.00
10/28/2022	0.00	0.00	0.00
10/29/2022	0.00	0.00	0.00
10/30/2022	0.00	0.00	0.00
10/31/2022	0.00	0.00	0.00
TOTAL	3.41		

2022 Daily Rainfall Data
Hybrid Rainfall (Cambridge DPW Gauge and USGS Freshpond Gauge)

Date	Rainfall (in)	Peak Intensity (in/hr)	Average Intensity (in/hr)
11/1/2022	0.00	0.00	0.00
11/2/2022	0.00	0.00	0.00
11/3/2022	0.00	0.00	0.00
11/4/2022	0.00	0.00	0.00
11/5/2022	0.00	0.00	0.00
11/6/2022	0.00	0.00	0.00
11/7/2022	0.00	0.00	0.00
11/8/2022	0.01	0.03	0.00
11/9/2022	0.00	0.00	0.00
11/10/2022	0.00	0.00	0.00
11/11/2022	0.29	0.33	0.01
11/12/2022	0.12	0.33	0.00
11/13/2022	0.16	0.09	0.01
11/14/2022	0.00	0.00	0.00
11/15/2022	0.01	0.03	0.00
11/16/2022	0.93	0.30	0.04
11/17/2022	0.00	0.00	0.00
11/18/2022	0.00	0.00	0.00
11/19/2022	0.00	0.00	0.00
11/20/2022	0.00	0.00	0.00
11/21/2022	0.00	0.00	0.00
11/22/2022	0.00	0.00	0.00
11/23/2022	0.00	0.00	0.00
11/24/2022	0.00	0.00	0.00
11/25/2022	0.00	0.00	0.00
11/26/2022	0.00	0.00	0.00
11/27/2022	0.59	0.24	0.02
11/28/2022	0.00	0.00	0.00
11/29/2022	0.00	0.00	0.00
11/30/2022	0.82	0.63	0.03
TOTAL	2.93		

2022 Daily Rainfall Data
Hybrid Rainfall (Cambridge DPW Gauge and USGS Freshpond Gauge)

Date	Rainfall (in)	Peak Intensity (in/hr)	Average Intensity (in/hr)
12/1/2022	0.00	0.00	0.00
12/2/2022	0.00	0.00	0.00
12/3/2022	0.21	0.12	0.01
12/4/2022	0.00	0.00	0.00
12/5/2022	0.00	0.00	0.00
12/6/2022	0.06	0.06	0.00
12/7/2022	0.71	0.24	0.03
12/8/2022	0.00	0.00	0.00
12/9/2022	0.00	0.00	0.00
12/10/2022	0.00	0.00	0.00
12/11/2022	0.00	0.00	0.00
12/12/2022	0.00	0.00	0.00
12/13/2022	0.00	0.00	0.00
12/14/2022	0.00	0.00	0.00
12/15/2022	0.05	0.03	0.00
12/16/2022	1.60	0.27	0.07
12/17/2022	0.15	0.06	0.01
12/18/2022	0.00	0.00	0.00
12/19/2022	0.00	0.00	0.00
12/20/2022	0.00	0.00	0.00
12/21/2022	0.00	0.00	0.00
12/22/2022	0.24	0.12	0.01
12/23/2022	1.49	0.30	0.06
12/24/2022	0.00	0.00	0.00
12/25/2022	0.00	0.00	0.00
12/26/2022	0.00	0.00	0.00
12/27/2022	0.00	0.00	0.00
12/28/2022	0.00	0.00	0.00
12/29/2022	0.00	0.00	0.00
12/30/2022	0.00	0.00	0.00
12/31/2022	0.33	0.12	0.01
TOTAL	4.84		

APPENDIX II

MONTHLY CSO ACTIVATIONS

2022 Daily Rainfall and Combined Sewer Overflow Volumes

Date	Rainfall	Alewife Brook								Charles River					
		CAM001		CAM002		CAM401A*		CAM401B		CAM005		CAM007		CAM017*	
	Hybrid (CDPW+USGS Brookline) in	Foch St. @ Alewife Brook Pkwy. MG	Hours	Mass. Ave. @ Alewife Brook Pkwy. MG	Hours	Sherman St. @ B&M Railroad MG	Hours	Mass Ave./Columbus Ave. @ Alewife MG	Hours	Lowell St. @ Mt. Auburn St. MG	Hours	Memorial Dr. @ Hawthorne St. MG	Hours	Edwin Land Blvd. @ Binney St. MG	Hours
1/1/2022	0.05	0.00	0.00	0.00	0.00	0.00	0.00	0.00	0.00	0.00	0.00	0.00	0.00	0.00	0.00
1/2/2022	0.19	0.00	0.00	0.00	0.00	0.00	0.00	0.00	0.00	0.00	0.00	0.00	0.00	0.00	0.00
1/3/2022	0.00	0.00	0.00	0.00	0.00	0.00	0.00	0.00	0.00	0.00	0.00	0.00	0.00	0.00	0.00
1/4/2022	0.00	0.00	0.00	0.00	0.00	0.00	0.00	0.00	0.00	0.00	0.00	0.00	0.00	0.00	0.00
1/5/2022	0.22	0.00	0.00	0.00	0.00	0.00	0.00	0.00	0.00	0.00	0.00	0.00	0.00	0.00	0.00
1/6/2022	0.00	0.00	0.00	0.00	0.00	0.00	0.00	0.00	0.00	0.00	0.00	0.00	0.00	0.00	0.00
1/7/2022	0.31	0.00	0.00	0.00	0.00	0.00	0.00	0.00	0.00	0.00	0.00	0.00	0.00	0.00	0.00
1/8/2022	0.00	0.00	0.00	0.00	0.00	0.00	0.00	0.00	0.00	0.00	0.00	0.00	0.00	0.00	0.00
1/9/2022	0.00	0.00	0.00	0.00	0.00	0.00	0.00	0.00	0.00	0.00	0.00	0.00	0.00	0.00	0.00
1/10/2022	0.00	0.00	0.00	0.00	0.00	0.00	0.00	0.00	0.00	0.00	0.00	0.00	0.00	0.00	0.00
1/11/2022	0.00	0.00	0.00	0.00	0.00	0.00	0.00	0.00	0.00	0.00	0.00	0.00	0.00	0.00	0.00
1/12/2022	0.00	0.00	0.00	0.00	0.00	0.00	0.00	0.00	0.00	0.00	0.00	0.00	0.00	0.00	0.00
1/13/2022	0.00	0.00	0.00	0.00	0.00	0.00	0.00	0.00	0.00	0.00	0.00	0.00	0.00	0.00	0.00
1/14/2022	0.00	0.00	0.00	0.00	0.00	0.00	0.00	0.00	0.00	0.00	0.00	0.00	0.00	0.00	0.00
1/15/2022	0.00	0.00	0.00	0.00	0.00	0.00	0.00	0.00	0.00	0.00	0.00	0.00	0.00	0.00	0.00
1/16/2022	0.00	0.00	0.00	0.00	0.00	0.00	0.00	0.00	0.00	0.00	0.00	0.00	0.00	0.00	0.00
1/17/2022	0.98	0.00	0.00	0.00	0.00	0.01	0.16	0.00	0.00	0.00	0.00	0.00	0.00	0.00	0.00
1/18/2022	0.00	0.00	0.00	0.00	0.00	0.00	0.00	0.00	0.00	0.00	0.00	0.00	0.00	0.00	0.00
1/19/2022	0.00	0.00	0.00	0.00	0.00	0.00	0.00	0.00	0.00	0.00	0.00	0.00	0.00	0.00	0.00
1/20/2022	0.06	0.00	0.00	0.00	0.00	0.00	0.00	0.00	0.00	0.00	0.00	0.00	0.00	0.00	0.00
1/21/2022	0.00	0.00	0.00	0.00	0.00	0.00	0.00	0.00	0.00	0.00	0.00	0.00	0.00	0.00	0.00
1/22/2022	0.00	0.00	0.00	0.00	0.00	0.00	0.00	0.00	0.00	0.00	0.00	0.00	0.00	0.00	0.00
1/23/2022	0.00	0.00	0.00	0.00	0.00	0.00	0.00	0.00	0.00	0.00	0.00	0.00	0.00	0.00	0.00
1/24/2022	0.00	0.00	0.00	0.00	0.00	0.00	0.00	0.00	0.00	0.00	0.00	0.00	0.00	0.00	0.00
1/25/2022	0.00	0.00	0.00	0.00	0.00	0.00	0.00	0.00	0.00	0.00	0.00	0.00	0.00	0.00	0.00
1/26/2022	0.00	0.00	0.00	0.00	0.00	0.00	0.00	0.00	0.00	0.00	0.00	0.00	0.00	0.00	0.00
1/27/2022	0.00	0.00	0.00	0.00	0.00	0.00	0.00	0.00	0.00	0.00	0.00	0.00	0.00	0.00	0.00
1/28/2022	0.00	0.00	0.00	0.00	0.00	0.00	0.00	0.00	0.00	0.00	0.00	0.00	0.00	0.00	0.00
1/29/2022	0.02	0.00	0.00	0.00	0.00	0.00	0.00	0.00	0.00	0.00	0.00	0.00	0.00	0.00	0.00
1/30/2022	0.00	0.00	0.00	0.00	0.00	0.00	0.00	0.00	0.00	0.00	0.00	0.00	0.00	0.00	0.00
1/31/2022	0.00	0.00	0.00	0.00	0.00	0.00	0.00	0.00	0.00	0.00	0.00	0.00	0.00	0.00	0.00
TOTAL	1.83	0.00	0.00	0.00	0.00	0.01	0.16	0.00	0.00	0.00	0.00	0.00	0.00	0.00	0.00

* CSO Volumes and durations calculated from meter data

2022 Daily Rainfall and Combined Sewer Overflow Volumes

Date	Rainfall	Alewife Brook								Charles River					
		CAM001		CAM002		CAM401A*		CAM401B		CAM005		CAM007		CAM017*	
	Hybrid (CDPW+USGS Brookline) in	Foch St. @ Alewife Brook Pkwy. MG	Hours	Mass. Ave. @ Alewife Brook Pkwy. MG	Hours	Sherman St. @ B&M Railroad MG	Hours	Mass Ave./Columbus Ave. @ Alewife MG	Hours	Lowell St. @ Mt. Auburn St. MG	Hours	Memorial Dr. @ Hawthorne St. MG	Hours	Edwin Land Blvd. @ Binney St. MG	Hours
2/1/2022	0.00	0.00	0.00	0.00	0.00	0.00	0.00	0.00	0.00	0.00	0.00	0.00	0.00	0.00	0.00
2/2/2022	0.00	0.00	0.00	0.00	0.00	0.00	0.00	0.00	0.00	0.00	0.00	0.00	0.00	0.00	0.00
2/3/2022	0.20	0.00	0.00	0.00	0.00	0.00	0.00	0.00	0.00	0.00	0.00	0.00	0.00	0.00	0.00
2/4/2022	1.14	0.00	0.00	0.00	0.00	0.01	0.16	0.00	0.00	0.00	0.00	0.00	0.00	0.00	0.00
2/5/2022	0.00	0.00	0.00	0.00	0.00	0.00	0.00	0.00	0.00	0.00	0.00	0.00	0.00	0.00	0.00
2/6/2022	0.00	0.00	0.00	0.00	0.00	0.00	0.00	0.00	0.00	0.00	0.00	0.00	0.00	0.00	0.00
2/7/2022	0.31	0.00	0.00	0.00	0.00	0.00	0.00	0.00	0.00	0.00	0.00	0.00	0.00	0.00	0.00
2/8/2022	0.40	0.00	0.00	0.00	0.00	0.00	0.00	0.00	0.00	0.00	0.00	0.00	0.00	0.00	0.00
2/9/2022	0.00	0.00	0.00	0.00	0.00	0.00	0.00	0.00	0.00	0.00	0.00	0.00	0.00	0.00	0.00
2/10/2022	0.00	0.00	0.00	0.00	0.00	0.00	0.00	0.00	0.00	0.00	0.00	0.00	0.00	0.00	0.00
2/11/2022	0.00	0.00	0.00	0.00	0.00	0.00	0.00	0.00	0.00	0.00	0.00	0.00	0.00	0.00	0.00
2/12/2022	0.00	0.00	0.00	0.00	0.00	0.00	0.00	0.00	0.00	0.00	0.00	0.00	0.00	0.00	0.00
2/13/2022	0.06	0.00	0.00	0.00	0.00	0.00	0.00	0.00	0.00	0.00	0.00	0.00	0.00	0.00	0.00
2/14/2022	0.00	0.00	0.00	0.00	0.00	0.00	0.00	0.00	0.00	0.00	0.00	0.00	0.00	0.00	0.00
2/15/2022	0.00	0.00	0.00	0.00	0.00	0.00	0.00	0.00	0.00	0.00	0.00	0.00	0.00	0.00	0.00
2/16/2022	0.00	0.00	0.00	0.00	0.00	0.00	0.00	0.00	0.00	0.00	0.00	0.00	0.00	0.00	0.00
2/17/2022	0.00	0.00	0.00	0.00	0.00	0.00	0.00	0.00	0.00	0.00	0.00	0.00	0.00	0.00	0.00
2/18/2022	0.38	0.00	0.00	0.00	0.00	0.00	0.00	0.00	0.00	0.00	0.00	0.00	0.00	0.00	0.00
2/19/2022	0.00	0.00	0.00	0.00	0.00	0.00	0.00	0.00	0.00	0.00	0.00	0.00	0.00	0.00	0.00
2/20/2022	0.00	0.00	0.00	0.00	0.00	0.00	0.00	0.00	0.00	0.00	0.00	0.00	0.00	0.00	0.00
2/21/2022	0.00	0.00	0.00	0.00	0.00	0.00	0.00	0.00	0.00	0.00	0.00	0.00	0.00	0.00	0.00
2/22/2022	0.47	0.00	0.00	0.00	0.00	0.00	0.00	0.00	0.00	0.00	0.00	0.00	0.00	0.00	0.00
2/23/2022	0.00	0.00	0.00	0.00	0.00	0.00	0.00	0.00	0.00	0.00	0.00	0.00	0.00	0.00	0.00
2/24/2022	0.00	0.00	0.00	0.00	0.00	0.00	0.00	0.00	0.00	0.00	0.00	0.00	0.00	0.00	0.00
2/25/2022	1.00	0.00	0.00	0.00	0.00	0.00	0.00	0.00	0.00	0.00	0.00	0.00	0.00	0.00	0.00
2/26/2022	0.00	0.00	0.00	0.00	0.00	0.00	0.00	0.00	0.00	0.00	0.00	0.00	0.00	0.00	0.00
2/27/2022	0.00	0.00	0.00	0.00	0.00	0.00	0.00	0.00	0.00	0.00	0.00	0.00	0.00	0.00	0.00
2/28/2022	0.00	0.00	0.00	0.00	0.00	0.00	0.00	0.00	0.00	0.00	0.00	0.00	0.00	0.00	0.00
TOTAL	3.95	0.00	0.00	0.00	0.00	0.01	0.16	0.00	0.00	0.00	0.00	0.00	0.00	0.00	0.00

* CSO Volumes and durations calculated from meter data

2022 Daily Rainfall and Combined Sewer Overflow Volumes

Date	Rainfall	Alewife Brook								Charles River					
		CAM001		CAM002		CAM401A*		CAM401B		CAM005		CAM007		CAM017*	
	Hybrid (CDPW+USGS Brookline) in	Foch St. @ Alewife Brook Pkwy. MG	Hours	Mass. Ave. @ Alewife Brook Pkwy. MG	Hours	Sherman St. @ B&M Railroad MG	Hours	Mass Ave./Columbus Ave. @ Alewife MG	Hours	Lowell St. @ Mt. Auburn St. MG	Hours	Memorial Dr. @ Hawthorne St. MG	Hours	Edwin Land Blvd. @ Binney St. MG	Hours
3/1/2022	0.08	0.00	0.00	0.00	0.00	0.00	0.00	0.00	0.00	0.00	0.00	0.00	0.00	0.00	0.00
3/2/2022	0.00	0.00	0.00	0.00	0.00	0.00	0.00	0.00	0.00	0.00	0.00	0.00	0.00	0.00	0.00
3/3/2022	0.15	0.00	0.00	0.00	0.00	0.00	0.00	0.00	0.00	0.00	0.00	0.00	0.00	0.00	0.00
3/4/2022	0.00	0.00	0.00	0.00	0.00	0.00	0.00	0.00	0.00	0.00	0.00	0.00	0.00	0.00	0.00
3/5/2022	0.00	0.00	0.00	0.00	0.00	0.00	0.00	0.00	0.00	0.00	0.00	0.00	0.00	0.00	0.00
3/6/2022	0.00	0.00	0.00	0.00	0.00	0.00	0.00	0.00	0.00	0.00	0.00	0.00	0.00	0.00	0.00
3/7/2022	0.17	0.00	0.00	0.00	0.00	0.00	0.00	0.00	0.00	0.00	0.00	0.00	0.00	0.00	0.00
3/8/2022	0.00	0.00	0.00	0.00	0.00	0.00	0.00	0.00	0.00	0.00	0.00	0.00	0.00	0.00	0.00
3/9/2022	0.19	0.00	0.00	0.00	0.00	0.00	0.00	0.00	0.00	0.00	0.00	0.00	0.00	0.00	0.00
3/10/2022	0.00	0.00	0.00	0.00	0.00	0.00	0.00	0.00	0.00	0.00	0.00	0.00	0.00	0.00	0.00
3/11/2022	0.00	0.00	0.00	0.00	0.00	0.00	0.00	0.00	0.00	0.00	0.00	0.00	0.00	0.00	0.00
3/12/2022	0.31	0.00	0.00	0.00	0.00	0.00	0.00	0.00	0.00	0.00	0.00	0.00	0.00	0.00	0.00
3/13/2022	0.00	0.00	0.00	0.00	0.00	0.00	0.00	0.00	0.00	0.00	0.00	0.00	0.00	0.00	0.00
3/14/2022	0.01	0.00	0.00	0.00	0.00	0.00	0.00	0.00	0.00	0.00	0.00	0.00	0.00	0.00	0.00
3/15/2022	0.00	0.00	0.00	0.00	0.00	0.00	0.00	0.00	0.00	0.00	0.00	0.00	0.00	0.00	0.00
3/16/2022	0.02	0.00	0.00	0.00	0.00	0.00	0.00	0.00	0.00	0.00	0.00	0.00	0.00	0.00	0.00
3/17/2022	0.00	0.00	0.00	0.00	0.00	0.00	0.00	0.00	0.00	0.00	0.00	0.00	0.00	0.00	0.00
3/18/2022	0.00	0.00	0.00	0.00	0.00	0.00	0.00	0.00	0.00	0.00	0.00	0.00	0.00	0.00	0.00
3/19/2022	0.11	0.00	0.00	0.00	0.00	0.00	0.00	0.00	0.00	0.00	0.00	0.00	0.00	0.00	0.00
3/20/2022	0.03	0.00	0.00	0.00	0.00	0.00	0.00	0.00	0.00	0.00	0.00	0.00	0.00	0.00	0.00
3/21/2022	0.00	0.00	0.00	0.00	0.00	0.00	0.00	0.00	0.00	0.00	0.00	0.00	0.00	0.00	0.00
3/22/2022	0.00	0.00	0.00	0.00	0.00	0.00	0.00	0.00	0.00	0.00	0.00	0.00	0.00	0.00	0.00
3/23/2022	0.00	0.00	0.00	0.00	0.00	0.00	0.00	0.00	0.00	0.00	0.00	0.00	0.00	0.00	0.00
3/24/2022	0.38	0.00	0.00	0.00	0.00	0.00	0.00	0.00	0.00	0.00	0.00	0.00	0.00	0.00	0.00
3/25/2022	0.47	0.00	0.00	0.00	0.00	0.00	0.00	0.00	0.00	0.00	0.00	0.00	0.00	0.00	0.00
3/26/2022	0.05	0.00	0.00	0.00	0.00	0.00	0.00	0.00	0.00	0.00	0.00	0.00	0.00	0.00	0.00
3/27/2022	0.00	0.00	0.00	0.00	0.00	0.00	0.00	0.00	0.00	0.00	0.00	0.00	0.00	0.00	0.00
3/28/2022	0.00	0.00	0.00	0.00	0.00	0.00	0.00	0.00	0.00	0.00	0.00	0.00	0.00	0.00	0.00
3/29/2022	0.00	0.00	0.00	0.00	0.00	0.00	0.00	0.00	0.00	0.00	0.00	0.00	0.00	0.00	0.00
3/30/2022	0.00	0.00	0.00	0.00	0.00	0.00	0.00	0.00	0.00	0.00	0.00	0.00	0.00	0.00	0.00
3/31/2022	0.02	0.00	0.00	0.00	0.00	0.00	0.00	0.00	0.00	0.00	0.00	0.00	0.00	0.00	0.00
TOTAL	1.99	0.00	0.00	0.00	0.00	0.00	0.00	0.00	0.00	0.00	0.00	0.00	0.00	0.00	0.00

* CSO Volumes and durations calculated from meter data

2022 Daily Rainfall and Combined Sewer Overflow Volumes

Date	Rainfall	Alewife Brook								Charles River					
		CAM001		CAM002		CAM401A*		CAM401B		CAM005		CAM007		CAM017*	
	Hybrid (CDPW+USGS Brookline) in	Foch St. @ Alewife Brook Pkwy. MG	Hours	Mass. Ave. @ Alewife Brook Pkwy. MG	Hours	Sherman St. @ B&M Railroad MG	Hours	Mass Ave./Columbus Ave. @ Alewife MG	Hours	Lowell St. @ Mt. Auburn St. MG	Hours	Memorial Dr. @ Hawthorne St. MG	Hours	Edwin Land Blvd. @ Binney St. MG	Hours
4/1/2022	0.27	0.00	0.00	0.00	0.00	0.00	0.00	0.00	0.00	0.00	0.00	0.00	0.00	0.00	0.00
4/2/2022	0.00	0.00	0.00	0.00	0.00	0.00	0.00	0.00	0.00	0.00	0.00	0.00	0.00	0.00	0.00
4/3/2022	0.00	0.00	0.00	0.00	0.00	0.00	0.00	0.00	0.00	0.00	0.00	0.00	0.00	0.00	0.00
4/4/2022	0.02	0.00	0.00	0.00	0.00	0.00	0.00	0.00	0.00	0.00	0.00	0.00	0.00	0.00	0.00
4/5/2022	0.00	0.00	0.00	0.00	0.00	0.00	0.00	0.00	0.00	0.00	0.00	0.00	0.00	0.00	0.00
4/6/2022	0.09	0.00	0.00	0.00	0.00	0.00	0.00	0.00	0.00	0.00	0.00	0.00	0.00	0.00	0.00
4/7/2022	0.02	0.00	0.00	0.00	0.00	0.00	0.00	0.00	0.00	0.00	0.00	0.00	0.00	0.00	0.00
4/8/2022	0.35	0.00	0.00	0.00	0.00	0.00	0.00	0.00	0.00	0.00	0.00	0.00	0.00	0.00	0.00
4/9/2022	0.14	0.00	0.00	0.00	0.00	0.00	0.00	0.00	0.00	0.00	0.00	0.00	0.00	0.00	0.00
4/10/2022	0.00	0.00	0.00	0.00	0.00	0.00	0.00	0.00	0.00	0.00	0.00	0.00	0.00	0.00	0.00
4/11/2022	0.00	0.00	0.00	0.00	0.00	0.00	0.00	0.00	0.00	0.00	0.00	0.00	0.00	0.00	0.00
4/12/2022	0.04	0.00	0.00	0.00	0.00	0.00	0.00	0.00	0.00	0.00	0.00	0.00	0.00	0.00	0.00
4/13/2022	0.00	0.00	0.00	0.00	0.00	0.00	0.00	0.00	0.00	0.00	0.00	0.00	0.00	0.00	0.00
4/14/2022	0.11	0.00	0.00	0.00	0.00	0.00	0.00	0.00	0.00	0.00	0.00	0.00	0.00	0.00	0.00
4/15/2022	0.02	0.00	0.00	0.00	0.00	0.00	0.00	0.00	0.00	0.00	0.00	0.00	0.00	0.00	0.00
4/16/2022	0.28	0.00	0.00	0.00	0.00	0.00	0.00	0.00	0.00	0.00	0.00	0.00	0.00	0.00	0.00
4/17/2022	0.08	0.00	0.00	0.00	0.00	0.00	0.00	0.00	0.00	0.00	0.00	0.00	0.00	0.00	0.00
4/18/2022	0.00	0.00	0.00	0.00	0.00	0.00	0.00	0.00	0.00	0.00	0.00	0.00	0.00	0.00	0.00
4/19/2022	1.05	0.00	0.00	0.00	0.00	0.00	0.00	0.00	0.00	0.11	2.00	0.00	0.00	0.00	0.00
4/20/2022	0.00	0.00	0.00	0.00	0.00	0.00	0.00	0.00	0.00	0.00	0.00	0.00	0.00	0.00	0.00
4/21/2022	0.00	0.00	0.00	0.00	0.00	0.00	0.00	0.00	0.00	0.00	0.00	0.00	0.00	0.00	0.00
4/22/2022	0.00	0.00	0.00	0.00	0.00	0.00	0.00	0.00	0.00	0.00	0.00	0.00	0.00	0.00	0.00
4/23/2022	0.00	0.00	0.00	0.00	0.00	0.00	0.00	0.00	0.00	0.00	0.00	0.00	0.00	0.00	0.00
4/24/2022	0.00	0.00	0.00	0.00	0.00	0.00	0.00	0.00	0.00	0.00	0.00	0.00	0.00	0.00	0.00
4/25/2022	0.00	0.00	0.00	0.00	0.00	0.00	0.00	0.00	0.00	0.00	0.00	0.00	0.00	0.00	0.00
4/26/2022	0.17	0.00	0.00	0.00	0.00	0.00	0.00	0.00	0.00	0.00	0.00	0.00	0.00	0.00	0.00
4/27/2022	0.09	0.00	0.00	0.00	0.00	0.00	0.00	0.00	0.00	0.00	0.00	0.00	0.00	0.00	0.00
4/28/2022	0.00	0.00	0.00	0.00	0.00	0.00	0.00	0.00	0.00	0.00	0.00	0.00	0.00	0.00	0.00
4/29/2022	0.00	0.00	0.00	0.00	0.00	0.00	0.00	0.00	0.00	0.00	0.00	0.00	0.00	0.00	0.00
4/30/2022	0.00	0.00	0.00	0.00	0.00	0.00	0.00	0.00	0.00	0.00	0.00	0.00	0.00	0.00	0.00
TOTAL	2.72	0.00	0.00	0.00	0.00	0.00	0.00	0.00	0.00	0.11	2.00	0.00	0.00	0.00	0.00

* CSO Volumes and durations calculated from meter data

2022 Daily Rainfall and Combined Sewer Overflow Volumes

Date	Rainfall	Alewife Brook								Charles River					
		CAM001		CAM002		CAM401A*		CAM401B		CAM005		CAM007		CAM017*	
	Hybrid (CDPW+USGS Brookline) in	Foch St. @ Alewife Brook Pkwy. MG	Hours	Mass. Ave. @ Alewife Brook Pkwy. MG	Hours	Sherman St. @ B&M Railroad MG	Hours	Mass Ave./Columbus Ave. @ Alewife MG	Hours	Lowell St. @ Mt. Auburn St. MG	Hours	Memorial Dr. @ Hawthorne St. MG	Hours	Edwin Land Blvd. @ Binney St. MG	Hours
5/1/2022	0.00	0.00	0.00	0.00	0.00	0.00	0.00	0.00	0.00	0.00	0.00	0.00	0.00	0.00	0.00
5/2/2022	0.17	0.00	0.00	0.00	0.00	0.00	0.00	0.00	0.00	0.00	0.00	0.00	0.00	0.00	0.00
5/3/2022	0.10	0.00	0.00	0.00	0.00	0.00	0.00	0.00	0.00	0.00	0.00	0.00	0.00	0.00	0.00
5/4/2022	0.10	0.00	0.00	0.00	0.00	0.00	0.00	0.00	0.00	0.00	0.00	0.00	0.00	0.00	0.00
5/5/2022	0.00	0.00	0.00	0.00	0.00	0.00	0.00	0.00	0.00	0.00	0.00	0.00	0.00	0.00	0.00
5/6/2022	0.00	0.00	0.00	0.00	0.00	0.00	0.00	0.00	0.00	0.00	0.00	0.00	0.00	0.00	0.00
5/7/2022	0.00	0.00	0.00	0.00	0.00	0.00	0.00	0.00	0.00	0.00	0.00	0.00	0.00	0.00	0.00
5/8/2022	0.00	0.00	0.00	0.00	0.00	0.00	0.00	0.00	0.00	0.00	0.00	0.00	0.00	0.00	0.00
5/9/2022	0.00	0.00	0.00	0.00	0.00	0.00	0.00	0.00	0.00	0.00	0.00	0.00	0.00	0.00	0.00
5/10/2022	0.00	0.00	0.00	0.00	0.00	0.00	0.00	0.00	0.00	0.00	0.00	0.00	0.00	0.00	0.00
5/11/2022	0.00	0.00	0.00	0.00	0.00	0.00	0.00	0.00	0.00	0.00	0.00	0.00	0.00	0.00	0.00
5/12/2022	0.00	0.00	0.00	0.00	0.00	0.00	0.00	0.00	0.00	0.00	0.00	0.00	0.00	0.00	0.00
5/13/2022	0.00	0.00	0.00	0.00	0.00	0.00	0.00	0.00	0.00	0.00	0.00	0.00	0.00	0.00	0.00
5/14/2022	0.00	0.00	0.00	0.00	0.00	0.00	0.00	0.00	0.00	0.00	0.00	0.00	0.00	0.00	0.00
5/15/2022	0.01	0.00	0.00	0.00	0.00	0.00	0.00	0.00	0.00	0.00	0.00	0.00	0.00	0.00	0.00
5/16/2022	0.15	0.00	0.00	0.00	0.00	0.00	0.00	0.00	0.00	0.00	0.00	0.00	0.00	0.00	0.00
5/17/2022	0.00	0.00	0.00	0.00	0.00	0.00	0.00	0.00	0.00	0.00	0.00	0.00	0.00	0.00	0.00
5/18/2022	0.00	0.00	0.00	0.00	0.00	0.00	0.00	0.00	0.00	0.00	0.00	0.00	0.00	0.00	0.00
5/19/2022	0.00	0.00	0.00	0.00	0.00	0.00	0.00	0.00	0.00	0.00	0.00	0.00	0.00	0.00	0.00
5/20/2022	0.00	0.00	0.00	0.00	0.00	0.00	0.00	0.00	0.00	0.00	0.00	0.00	0.00	0.00	0.00
5/21/2022	0.00	0.00	0.00	0.00	0.00	0.00	0.00	0.00	0.00	0.00	0.00	0.00	0.00	0.00	0.00
5/22/2022	0.00	0.00	0.00	0.00	0.00	0.00	0.00	0.00	0.00	0.00	0.00	0.00	0.00	0.00	0.00
5/23/2022	0.00	0.00	0.00	0.00	0.00	0.00	0.00	0.00	0.00	0.00	0.00	0.00	0.00	0.00	0.00
5/24/2022	0.00	0.00	0.00	0.00	0.00	0.00	0.00	0.00	0.00	0.00	0.00	0.00	0.00	0.00	0.00
5/25/2022	0.00	0.00	0.00	0.00	0.00	0.00	0.00	0.00	0.00	0.00	0.00	0.00	0.00	0.00	0.00
5/26/2022	0.00	0.00	0.00	0.00	0.00	0.00	0.00	0.00	0.00	0.00	0.00	0.00	0.00	0.00	0.00
5/27/2022	0.00	0.00	0.00	0.00	0.00	0.00	0.00	0.00	0.00	0.00	0.00	0.00	0.00	0.00	0.00
5/28/2022	0.52	0.00	0.00	0.00	0.00	0.00	0.00	0.00	0.00	0.00	0.00	0.00	0.00	0.00	0.00
5/29/2022	0.00	0.00	0.00	0.00	0.00	0.00	0.00	0.00	0.00	0.00	0.00	0.00	0.00	0.00	0.00
5/30/2022	0.00	0.00	0.00	0.00	0.00	0.00	0.00	0.00	0.00	0.00	0.00	0.00	0.00	0.00	0.00
5/31/2022	0.01	0.00	0.00	0.00	0.00	0.00	0.00	0.00	0.00	0.00	0.00	0.00	0.00	0.00	0.00
TOTAL	1.06	0.00	0.00	0.00	0.00	0.00	0.00	0.00	0.00	0.00	0.00	0.00	0.00	0.00	0.00

* CSO Volumes and durations calculated from meter data

2022 Daily Rainfall and Combined Sewer Overflow Volumes

Date	Rainfall	Alewife Brook								Charles River					
		CAM001		CAM002		CAM401A*		CAM401B		CAM005		CAM007		CAM017*	
	Hybrid (CDPW+USGS Brookline) in	Foch St. @ Alewife Brook Pkwy.		Mass. Ave. @ Alewife Brook Pkwy.		Sherman St. @ B&M Railroad		Mass Ave./Columbus Ave. @ Alewife		Lowell St. @ Mt. Auburn St.		Memorial Dr. @ Hawthorne St.		Edwin Land Blvd. @ Binney St.	
		MG	Hours	MG	Hours	MG	Hours	MG	Hours	MG	Hours	MG	Hours	MG	Hours
6/1/2022	0.18	0.00	0.00	0.00	0.00	0.00	0.00	0.00	0.00	0.00	0.00	0.00	0.00	0.00	0.00
6/2/2022	0.10	0.00	0.00	0.00	0.00	0.00	0.00	0.00	0.00	0.00	0.00	0.00	0.00	0.00	0.00
6/3/2022	0.01	0.00	0.00	0.00	0.00	0.00	0.00	0.00	0.00	0.00	0.00	0.00	0.00	0.00	0.00
6/4/2022	0.00	0.00	0.00	0.00	0.00	0.00	0.00	0.00	0.00	0.00	0.00	0.00	0.00	0.00	0.00
6/5/2022	0.00	0.00	0.00	0.00	0.00	0.00	0.00	0.00	0.00	0.00	0.00	0.00	0.00	0.00	0.00
6/6/2022	0.00	0.00	0.00	0.00	0.00	0.00	0.00	0.00	0.00	0.00	0.00	0.00	0.00	0.00	0.00
6/7/2022	0.00	0.00	0.00	0.00	0.00	0.00	0.00	0.00	0.00	0.00	0.00	0.00	0.00	0.00	0.00
6/8/2022	0.00	0.00	0.00	0.00	0.00	0.00	0.00	0.00	0.00	0.00	0.00	0.00	0.00	0.00	0.00
6/9/2022	0.00	0.00	0.00	0.00	0.00	0.00	0.00	0.00	0.00	0.00	0.00	0.00	0.00	0.00	0.00
6/10/2022	0.00	0.00	0.00	0.00	0.00	0.00	0.00	0.00	0.00	0.00	0.00	0.00	0.00	0.00	0.00
6/11/2022	0.00	0.00	0.00	0.00	0.00	0.00	0.00	0.00	0.00	0.00	0.00	0.00	0.00	0.00	0.00
6/12/2022	0.00	0.00	0.00	0.00	0.00	0.00	0.00	0.00	0.00	0.00	0.00	0.00	0.00	0.00	0.00
6/13/2022	0.00	0.00	0.00	0.00	0.00	0.00	0.00	0.00	0.00	0.00	0.00	0.00	0.00	0.00	0.00
6/14/2022	0.00	0.00	0.00	0.00	0.00	0.00	0.00	0.00	0.00	0.00	0.00	0.00	0.00	0.00	0.00
6/15/2022	0.00	0.00	0.00	0.00	0.00	0.00	0.00	0.00	0.00	0.00	0.00	0.00	0.00	0.00	0.00
6/16/2022	0.00	0.00	0.00	0.00	0.00	0.00	0.00	0.00	0.00	0.00	0.00	0.00	0.00	0.00	0.00
6/17/2022	0.00	0.00	0.00	0.00	0.00	0.00	0.00	0.00	0.00	0.00	0.00	0.00	0.00	0.00	0.00
6/18/2022	0.00	0.00	0.00	0.00	0.00	0.00	0.00	0.00	0.00	0.00	0.00	0.00	0.00	0.00	0.00
6/19/2022	0.00	0.00	0.00	0.00	0.00	0.00	0.00	0.00	0.00	0.00	0.00	0.00	0.00	0.00	0.00
6/20/2022	0.00	0.00	0.00	0.00	0.00	0.00	0.00	0.00	0.00	0.00	0.00	0.00	0.00	0.00	0.00
6/21/2022	0.00	0.00	0.00	0.00	0.00	0.00	0.00	0.00	0.00	0.00	0.00	0.00	0.00	0.00	0.00
6/22/2022	0.00	0.00	0.00	0.00	0.00	0.00	0.00	0.00	0.00	0.00	0.00	0.00	0.00	0.00	0.00
6/23/2022	0.00	0.00	0.00	0.00	0.00	0.00	0.00	0.00	0.00	0.00	0.00	0.00	0.00	0.00	0.00
6/24/2022	0.00	0.00	0.00	0.00	0.00	0.00	0.00	0.00	0.00	0.00	0.00	0.00	0.00	0.00	0.00
6/25/2022	0.00	0.00	0.00	0.00	0.00	0.00	0.00	0.00	0.00	0.00	0.00	0.00	0.00	0.00	0.00
6/26/2022	0.00	0.00	0.00	0.00	0.00	0.00	0.00	0.00	0.00	0.00	0.00	0.00	0.00	0.00	0.00
6/27/2022	0.94	0.00	0.00	0.00	0.00	0.00	0.00	0.00	0.00	0.01	0.25	0.00	0.00	0.00	0.00
6/28/2022	0.00	0.00	0.00	0.00	0.00	0.00	0.00	0.00	0.00	0.00	0.00	0.00	0.00	0.00	0.00
6/29/2022	0.00	0.00	0.00	0.00	0.00	0.00	0.00	0.00	0.00	0.00	0.00	0.00	0.00	0.00	0.00
6/30/2022	0.01	0.00	0.00	0.00	0.00	0.00	0.00	0.00	0.00	0.00	0.00	0.00	0.00	0.00	0.00
TOTAL	1.24	0.00	0.00	0.00	0.00	0.00	0.00	0.00	0.00	0.01	0.25	0.00	0.00	0.00	0.00

* CSO Volumes and durations calculated from meter data

2022 Daily Rainfall and Combined Sewer Overflow Volumes

Date	Rainfall	Alewife Brook								Charles River					
		CAM001		CAM002		CAM401A*		CAM401B		CAM005		CAM007		CAM017*	
	Hybrid (CDPW+USGS Brookline) in	Foch St. @ Alewife Brook Pkwy. MG	Hours	Mass. Ave. @ Alewife Brook Pkwy. MG	Hours	Sherman St. @ B&M Railroad MG	Hours	Mass Ave./Columbus Ave. @ Alewife MG	Hours	Lowell St. @ Mt. Auburn St. MG	Hours	Memorial Dr. @ Hawthorne St. MG	Hours	Edwin Land Blvd. @ Binney St. MG	Hours
7/1/2022	0.00	0.00	0.00	0.00	0.00	0.00	0.00	0.00	0.00	0.00	0.00	0.00	0.00	0.00	0.00
7/2/2022	0.19	0.00	0.00	0.00	0.00	0.00	0.00	0.00	0.00	0.00	0.00	0.00	0.00	0.00	0.00
7/3/2022	0.00	0.00	0.00	0.00	0.00	0.00	0.00	0.00	0.00	0.00	0.00	0.00	0.00	0.00	0.00
7/4/2022	0.00	0.00	0.00	0.00	0.00	0.00	0.00	0.00	0.00	0.00	0.00	0.00	0.00	0.00	0.00
7/5/2022	0.10	0.00	0.00	0.00	0.00	0.00	0.00	0.00	0.00	0.00	0.00	0.00	0.00	0.00	0.00
7/6/2022	0.00	0.00	0.00	0.00	0.00	0.00	0.00	0.00	0.00	0.00	0.00	0.00	0.00	0.00	0.00
7/7/2022	0.00	0.00	0.00	0.00	0.00	0.00	0.00	0.00	0.00	0.00	0.00	0.00	0.00	0.00	0.00
7/8/2022	0.00	0.00	0.00	0.00	0.00	0.00	0.00	0.00	0.00	0.00	0.00	0.00	0.00	0.00	0.00
7/9/2022	0.00	0.00	0.00	0.00	0.00	0.00	0.00	0.00	0.00	0.00	0.00	0.00	0.00	0.00	0.00
7/10/2022	0.00	0.00	0.00	0.00	0.00	0.00	0.00	0.00	0.00	0.00	0.00	0.00	0.00	0.00	0.00
7/11/2022	0.00	0.00	0.00	0.00	0.00	0.00	0.00	0.00	0.00	0.00	0.00	0.00	0.00	0.00	0.00
7/12/2022	0.00	0.00	0.00	0.00	0.00	0.00	0.00	0.00	0.00	0.00	0.00	0.00	0.00	0.00	0.00
7/13/2022	0.00	0.00	0.00	0.00	0.00	0.00	0.00	0.00	0.00	0.00	0.00	0.00	0.00	0.00	0.00
7/14/2022	0.31	0.00	0.00	0.00	0.00	0.00	0.00	0.00	0.00	0.00	0.00	0.00	0.00	0.00	0.00
7/15/2022	0.00	0.00	0.00	0.00	0.00	0.00	0.00	0.00	0.00	0.00	0.00	0.00	0.00	0.00	0.00
7/16/2022	0.00	0.00	0.00	0.00	0.00	0.00	0.00	0.00	0.00	0.00	0.00	0.00	0.00	0.00	0.00
7/17/2022	0.00	0.00	0.00	0.00	0.00	0.00	0.00	0.00	0.00	0.00	0.00	0.00	0.00	0.00	0.00
7/18/2022	0.07	0.00	0.00	0.00	0.00	0.00	0.00	0.00	0.00	0.00	0.00	0.00	0.00	0.00	0.00
7/19/2022	0.02	0.00	0.00	0.00	0.00	0.00	0.00	0.00	0.00	0.00	0.00	0.00	0.00	0.00	0.00
7/20/2022	0.00	0.00	0.00	0.00	0.00	0.00	0.00	0.00	0.00	0.00	0.00	0.00	0.00	0.00	0.00
7/21/2022	0.00	0.00	0.00	0.00	0.00	0.00	0.00	0.00	0.00	0.00	0.00	0.00	0.00	0.00	0.00
7/22/2022	0.00	0.00	0.00	0.00	0.00	0.00	0.00	0.00	0.00	0.00	0.00	0.00	0.00	0.00	0.00
7/23/2022	0.00	0.00	0.00	0.00	0.00	0.00	0.00	0.00	0.00	0.00	0.00	0.00	0.00	0.00	0.00
7/24/2022	0.00	0.00	0.00	0.00	0.00	0.00	0.00	0.00	0.00	0.00	0.00	0.00	0.00	0.00	0.00
7/25/2022	0.08	0.00	0.00	0.00	0.00	0.00	0.00	0.00	0.00	0.00	0.00	0.00	0.00	0.00	0.00
7/26/2022	0.00	0.00	0.00	0.00	0.00	0.00	0.00	0.00	0.00	0.00	0.00	0.00	0.00	0.00	0.00
7/27/2022	0.00	0.00	0.00	0.00	0.00	0.00	0.00	0.00	0.00	0.00	0.00	0.00	0.00	0.00	0.00
7/28/2022	0.02	0.00	0.00	0.00	0.00	0.00	0.00	0.00	0.00	0.00	0.00	0.00	0.00	0.00	0.00
7/29/2022	0.00	0.00	0.00	0.00	0.00	0.00	0.00	0.00	0.00	0.00	0.00	0.00	0.00	0.00	0.00
7/30/2022	0.00	0.00	0.00	0.00	0.00	0.00	0.00	0.00	0.00	0.00	0.00	0.00	0.00	0.00	0.00
7/31/2022	0.00	0.00	0.00	0.00	0.00	0.00	0.00	0.00	0.00	0.00	0.00	0.00	0.00	0.00	0.00
TOTAL	0.79	0.00	0.00	0.00	0.00	0.00	0.00	0.00	0.00	0.00	0.00	0.00	0.00	0.00	0.00

* CSO Volumes and durations calculated from meter data

2022 Daily Rainfall and Combined Sewer Overflow Volumes

Date	Rainfall	Alewife Brook								Charles River					
		CAM001		CAM002		CAM401A*		CAM401B		CAM005		CAM007		CAM017*	
	Hybrid (CDPW+USGS Brookline) in	Foch St. @ Alewife Brook Pkwy. MG	Hours	Mass. Ave. @ Alewife Brook Pkwy. MG	Hours	Sherman St. @ B&M Railroad MG	Hours	Mass Ave./Columbus Ave. @ Alewife MG	Hours	Lowell St. @ Mt. Auburn St. MG	Hours	Memorial Dr. @ Hawthorne St. MG	Hours	Edwin Land Blvd. @ Binney St. MG	Hours
8/1/2022	0.02	0.00	0.00	0.00	0.00	0.00	0.00	0.00	0.00	0.00	0.00	0.00	0.00	0.00	0.00
8/2/2022	0.00	0.00	0.00	0.00	0.00	0.00	0.00	0.00	0.00	0.00	0.00	0.00	0.00	0.00	0.00
8/3/2022	0.00	0.00	0.00	0.00	0.00	0.00	0.00	0.00	0.00	0.00	0.00	0.00	0.00	0.00	0.00
8/4/2022	0.00	0.00	0.00	0.00	0.00	0.00	0.00	0.00	0.00	0.00	0.00	0.00	0.00	0.00	0.00
8/5/2022	0.10	0.00	0.00	0.00	0.00	0.01	0.16	0.00	0.00	0.00	0.00	0.00	0.00	0.00	0.00
8/6/2022	0.00	0.00	0.00	0.00	0.00	0.00	0.00	0.00	0.00	0.00	0.00	0.00	0.00	0.00	0.00
8/7/2022	0.13	0.00	0.00	0.00	0.00	0.00	0.00	0.00	0.00	0.00	0.00	0.00	0.00	0.00	0.00
8/8/2022	0.00	0.00	0.00	0.00	0.00	0.00	0.00	0.00	0.00	0.00	0.00	0.00	0.00	0.00	0.00
8/9/2022	0.05	0.00	0.00	0.00	0.00	0.00	0.00	0.00	0.00	0.00	0.00	0.00	0.00	0.00	0.00
8/10/2022	0.00	0.00	0.00	0.00	0.00	0.00	0.00	0.00	0.00	0.00	0.00	0.00	0.00	0.00	0.00
8/11/2022	0.00	0.00	0.00	0.00	0.00	0.00	0.00	0.00	0.00	0.00	0.00	0.00	0.00	0.00	0.00
8/12/2022	0.00	0.00	0.00	0.00	0.00	0.00	0.00	0.00	0.00	0.00	0.00	0.00	0.00	0.00	0.00
8/13/2022	0.00	0.00	0.00	0.00	0.00	0.00	0.00	0.00	0.00	0.00	0.00	0.00	0.00	0.00	0.00
8/14/2022	0.00	0.00	0.00	0.00	0.00	0.00	0.00	0.00	0.00	0.00	0.00	0.00	0.00	0.00	0.00
8/15/2022	0.00	0.00	0.00	0.00	0.00	0.00	0.00	0.00	0.00	0.00	0.00	0.00	0.00	0.00	0.00
8/16/2022	0.00	0.00	0.00	0.00	0.00	0.00	0.00	0.00	0.00	0.00	0.00	0.00	0.00	0.00	0.00
8/17/2022	0.00	0.00	0.00	0.00	0.00	0.00	0.00	0.00	0.00	0.00	0.00	0.00	0.00	0.00	0.00
8/18/2022	0.00	0.00	0.00	0.00	0.00	0.00	0.00	0.00	0.00	0.00	0.00	0.00	0.00	0.00	0.00
8/19/2022	0.00	0.00	0.00	0.00	0.00	0.00	0.00	0.00	0.00	0.00	0.00	0.00	0.00	0.00	0.00
8/20/2022	0.00	0.00	0.00	0.00	0.00	0.00	0.00	0.00	0.00	0.00	0.00	0.00	0.00	0.00	0.00
8/21/2022	0.00	0.00	0.00	0.00	0.00	0.00	0.00	0.00	0.00	0.00	0.00	0.00	0.00	0.00	0.00
8/22/2022	0.42	0.00	0.00	0.00	0.00	0.00	0.00	0.00	0.00	0.00	0.00	0.00	0.00	0.00	0.00
8/23/2022	0.00	0.00	0.00	0.00	0.00	0.00	0.00	0.00	0.00	0.00	0.00	0.00	0.00	0.00	0.00
8/24/2022	0.00	0.00	0.00	0.00	0.00	0.00	0.00	0.00	0.00	0.00	0.00	0.00	0.00	0.00	0.00
8/25/2022	0.00	0.00	0.00	0.00	0.00	0.00	0.00	0.00	0.00	0.00	0.00	0.00	0.00	0.00	0.00
8/26/2022	0.44	0.00	0.00	0.00	0.00	0.12	0.33	0.00	0.00	0.01	0.25	0.00	0.00	0.00	0.00
8/27/2022	0.00	0.00	0.00	0.00	0.00	0.00	0.00	0.00	0.00	0.00	0.00	0.00	0.00	0.00	0.00
8/28/2022	0.04	0.00	0.00	0.00	0.00	0.00	0.00	0.00	0.00	0.00	0.00	0.00	0.00	0.00	0.00
8/29/2022	0.00	0.00	0.00	0.00	0.00	0.00	0.00	0.00	0.00	0.00	0.00	0.00	0.00	0.00	0.00
8/30/2022	0.00	0.00	0.00	0.00	0.00	0.00	0.00	0.00	0.00	0.00	0.00	0.00	0.00	0.00	0.00
8/31/2022	0.13	0.00	0.00	0.00	0.00	0.00	0.00	0.00	0.00	0.00	0.00	0.00	0.00	0.00	0.00
TOTAL	1.33	0.00	0.00	0.00	0.00	0.13	0.49	0.00	0.00	0.01	0.25	0.00	0.00	0.00	0.00

* CSO Volumes and durations calculated from meter data

2022 Daily Rainfall and Combined Sewer Overflow Volumes

Date	Rainfall	Alewife Brook								Charles River					
		CAM001		CAM002		CAM401A*		CAM401B		CAM005		CAM007		CAM017*	
	Hybrid (CDPW+USGS Brookline) in	Foch St. @ Alewife Brook Pkwy. MG	Hours	Mass. Ave. @ Alewife Brook Pkwy. MG	Hours	Sherman St. @ B&M Railroad MG	Hours	Mass Ave./Columbus Ave. @ Alewife MG	Hours	Lowell St. @ Mt. Auburn St. MG	Hours	Memorial Dr. @ Hawthorne St. MG	Hours	Edwin Land Blvd. @ Binney St. MG	Hours
9/1/2022	0.00	0.00	0.00	0.00	0.00	0.00	0.00	0.00	0.00	0.00	0.00	0.00	0.00	0.00	0.00
9/2/2022	0.01	0.00	0.00	0.00	0.00	0.00	0.00	0.00	0.00	0.00	0.00	0.00	0.00	0.00	0.00
9/3/2022	0.00	0.00	0.00	0.00	0.00	0.00	0.00	0.00	0.00	0.00	0.00	0.00	0.00	0.00	0.00
9/4/2022	0.00	0.00	0.00	0.00	0.00	0.00	0.00	0.00	0.00	0.00	0.00	0.00	0.00	0.00	0.00
9/5/2022	0.53	0.00	0.00	0.00	0.00	0.00	0.00	0.00	0.00	0.00	0.00	0.00	0.00	0.00	0.00
9/6/2022	0.66	0.00	0.00	0.00	0.00	0.00	0.00	0.00	0.00	0.00	0.00	0.00	0.00	0.00	0.00
9/7/2022	0.00	0.00	0.00	0.00	0.00	0.00	0.00	0.00	0.00	0.00	0.00	0.00	0.00	0.00	0.00
9/8/2022	0.00	0.00	0.00	0.00	0.00	0.00	0.00	0.00	0.00	0.00	0.00	0.00	0.00	0.00	0.00
9/9/2022	0.00	0.00	0.00	0.00	0.00	0.00	0.00	0.00	0.00	0.00	0.00	0.00	0.00	0.00	0.00
9/10/2022	0.00	0.00	0.00	0.00	0.00	0.00	0.00	0.00	0.00	0.00	0.00	0.00	0.00	0.00	0.00
9/11/2022	0.00	0.00	0.00	0.00	0.00	0.00	0.00	0.00	0.00	0.00	0.00	0.00	0.00	0.00	0.00
9/12/2022	0.00	0.00	0.00	0.00	0.00	0.00	0.00	0.00	0.00	0.00	0.00	0.00	0.00	0.00	0.00
9/13/2022	0.11	0.00	0.00	0.00	0.00	0.00	0.00	0.00	0.00	0.00	0.00	0.00	0.00	0.00	0.00
9/14/2022	0.00	0.00	0.00	0.00	0.00	0.00	0.00	0.00	0.00	0.00	0.00	0.00	0.00	0.00	0.00
9/15/2022	0.00	0.00	0.00	0.00	0.00	0.00	0.00	0.00	0.00	0.00	0.00	0.00	0.00	0.00	0.00
9/16/2022	0.00	0.00	0.00	0.00	0.00	0.00	0.00	0.00	0.00	0.00	0.00	0.00	0.00	0.00	0.00
9/17/2022	0.00	0.00	0.00	0.00	0.00	0.00	0.00	0.00	0.00	0.00	0.00	0.00	0.00	0.00	0.00
9/18/2022	0.00	0.00	0.00	0.00	0.00	0.00	0.00	0.00	0.00	0.00	0.00	0.00	0.00	0.00	0.00
9/19/2022	0.29	0.00	0.00	0.00	0.00	0.01	0.08	0.00	0.00	0.00	0.00	0.00	0.00	0.00	0.00
9/20/2022	0.02	0.00	0.00	0.00	0.00	0.00	0.00	0.00	0.00	0.00	0.00	0.00	0.00	0.00	0.00
9/21/2022	0.02	0.00	0.00	0.00	0.00	0.00	0.00	0.00	0.00	0.00	0.00	0.00	0.00	0.00	0.00
9/22/2022	0.69	0.00	0.00	0.00	0.00	0.00	0.00	0.00	0.00	0.00	0.00	0.00	0.00	0.00	0.00
9/23/2022	0.00	0.00	0.00	0.00	0.00	0.00	0.00	0.00	0.00	0.00	0.00	0.00	0.00	0.00	0.00
9/24/2022	0.00	0.00	0.00	0.00	0.00	0.00	0.00	0.00	0.00	0.00	0.00	0.00	0.00	0.00	0.00
9/25/2022	0.00	0.00	0.00	0.00	0.00	0.00	0.00	0.00	0.00	0.00	0.00	0.00	0.00	0.00	0.00
9/26/2022	0.25	0.00	0.00	0.00	0.00	0.00	0.00	0.00	0.00	0.00	0.00	0.00	0.00	0.00	0.00
9/27/2022	0.01	0.00	0.00	0.00	0.00	0.00	0.00	0.00	0.00	0.00	0.00	0.00	0.00	0.00	0.00
9/28/2022	0.00	0.00	0.00	0.00	0.00	0.00	0.00	0.00	0.00	0.00	0.00	0.00	0.00	0.00	0.00
9/29/2022	0.00	0.00	0.00	0.00	0.00	0.00	0.00	0.00	0.00	0.00	0.00	0.00	0.00	0.00	0.00
9/30/2022	0.00	0.00	0.00	0.00	0.00	0.00	0.00	0.00	0.00	0.00	0.00	0.00	0.00	0.00	0.00
TOTAL	2.58	0.00	0.00	0.00	0.00	0.01	0.08	0.00	0.00	0.00	0.00	0.00	0.00	0.00	0.00

* CSO Volumes and durations calculated from meter data

2022 Daily Rainfall and Combined Sewer Overflow Volumes

Date	Rainfall	Alewife Brook								Charles River					
		CAM001		CAM002		CAM401A*		CAM401B		CAM005		CAM007		CAM017*	
	Hybrid (CDPW+USGS Brookline) in	Foch St. @ Alewife Brook Pkwy. MG	Hours	Mass. Ave. @ Alewife Brook Pkwy. MG	Hours	Sherman St. @ B&M Railroad MG	Hours	Mass Ave./Columbus Ave. @ Alewife MG	Hours	Lowell St. @ Mt. Auburn St. MG	Hours	Memorial Dr. @ Hawthorne St. MG	Hours	Edwin Land Blvd. @ Binney St. MG	Hours
10/1/2022	0.01	0.00	0.00	0.00	0.00	0.00	0.00	0.00	0.00	0.00	0.00	0.00	0.00	0.00	0.00
10/2/2022	0.00	0.00	0.00	0.00	0.00	0.00	0.00	0.00	0.00	0.00	0.00	0.00	0.00	0.00	0.00
10/3/2022	0.00	0.00	0.00	0.00	0.00	0.00	0.00	0.00	0.00	0.00	0.00	0.00	0.00	0.00	0.00
10/4/2022	0.32	0.00	0.00	0.00	0.00	0.00	0.00	0.00	0.00	0.00	0.00	0.00	0.00	0.00	0.00
10/5/2022	0.37	0.00	0.00	0.00	0.00	0.00	0.00	0.00	0.00	0.00	0.00	0.00	0.00	0.00	0.00
10/6/2022	0.02	0.00	0.00	0.00	0.00	0.00	0.00	0.00	0.00	0.00	0.00	0.00	0.00	0.00	0.00
10/7/2022	0.00	0.00	0.00	0.00	0.00	0.00	0.00	0.00	0.00	0.00	0.00	0.00	0.00	0.00	0.00
10/8/2022	0.00	0.00	0.00	0.00	0.00	0.00	0.00	0.00	0.00	0.00	0.00	0.00	0.00	0.00	0.00
10/9/2022	0.00	0.00	0.00	0.00	0.00	0.00	0.00	0.00	0.00	0.00	0.00	0.00	0.00	0.00	0.00
10/10/2022	0.01	0.00	0.00	0.00	0.00	0.00	0.00	0.00	0.00	0.00	0.00	0.00	0.00	0.00	0.00
10/11/2022	0.01	0.00	0.00	0.00	0.00	0.00	0.00	0.00	0.00	0.00	0.00	0.00	0.00	0.00	0.00
10/12/2022	0.00	0.00	0.00	0.00	0.00	0.00	0.00	0.00	0.00	0.00	0.00	0.00	0.00	0.00	0.00
10/13/2022	0.73	0.00	0.00	0.00	0.00	0.00	0.00	0.00	0.00	0.00	0.00	0.00	0.00	0.00	0.00
10/14/2022	0.97	0.00	0.00	0.00	0.00	0.19	0.67	0.00	0.00	0.03	0.25	0.00	0.00	0.00	0.00
10/15/2022	0.00	0.00	0.00	0.00	0.00	0.00	0.00	0.00	0.00	0.00	0.00	0.00	0.00	0.00	0.00
10/16/2022	0.00	0.00	0.00	0.00	0.00	0.00	0.00	0.00	0.00	0.00	0.00	0.00	0.00	0.00	0.00
10/17/2022	0.15	0.00	0.00	0.00	0.00	0.00	0.00	0.00	0.00	0.00	0.00	0.00	0.00	0.00	0.00
10/18/2022	0.20	0.00	0.00	0.00	0.00	0.00	0.00	0.00	0.00	0.00	0.00	0.00	0.00	0.00	0.00
10/19/2022	0.00	0.00	0.00	0.00	0.00	0.00	0.00	0.00	0.00	0.00	0.00	0.00	0.00	0.00	0.00
10/20/2022	0.00	0.00	0.00	0.00	0.00	0.00	0.00	0.00	0.00	0.00	0.00	0.00	0.00	0.00	0.00
10/21/2022	0.00	0.00	0.00	0.00	0.00	0.00	0.00	0.00	0.00	0.00	0.00	0.00	0.00	0.00	0.00
10/22/2022	0.00	0.00	0.00	0.00	0.00	0.00	0.00	0.00	0.00	0.00	0.00	0.00	0.00	0.00	0.00
10/23/2022	0.04	0.00	0.00	0.00	0.00	0.00	0.00	0.00	0.00	0.00	0.00	0.00	0.00	0.00	0.00
10/24/2022	0.15	0.00	0.00	0.00	0.00	0.00	0.00	0.00	0.00	0.00	0.00	0.00	0.00	0.00	0.00
10/25/2022	0.17	0.00	0.00	0.00	0.00	0.00	0.00	0.00	0.00	0.00	0.00	0.00	0.00	0.00	0.00
10/26/2022	0.27	0.00	0.00	0.00	0.00	0.00	0.00	0.00	0.00	0.00	0.00	0.00	0.00	0.00	0.00
10/27/2022	0.00	0.00	0.00	0.00	0.00	0.00	0.00	0.00	0.00	0.00	0.00	0.00	0.00	0.00	0.00
10/28/2022	0.00	0.00	0.00	0.00	0.00	0.00	0.00	0.00	0.00	0.00	0.00	0.00	0.00	0.00	0.00
10/29/2022	0.00	0.00	0.00	0.00	0.00	0.00	0.00	0.00	0.00	0.00	0.00	0.00	0.00	0.00	0.00
10/30/2022	0.00	0.00	0.00	0.00	0.00	0.00	0.00	0.00	0.00	0.00	0.00	0.00	0.00	0.00	0.00
10/31/2022	0.00	0.00	0.00	0.00	0.00	0.00	0.00	0.00	0.00	0.00	0.00	0.00	0.00	0.00	0.00
TOTAL	3.41	0.00	0.00	0.00	0.00	0.19	0.67	0.00	0.00	0.03	0.25	0.00	0.00	0.00	0.00

* CSO Volumes and durations calculated from meter data

2022 Daily Rainfall and Combined Sewer Overflow Volumes

Date	Rainfall	Alewife Brook								Charles River					
		CAM001		CAM002		CAM401A*		CAM401B		CAM005		CAM007		CAM017*	
	Hybrid (CDPW+USGS Brookline) in	Foch St. @ Alewife Brook Pkwy. MG	Hours	Mass. Ave. @ Alewife Brook Pkwy. MG	Hours	Sherman St. @ B&M Railroad MG	Hours	Mass Ave./Columbus Ave. @ Alewife MG	Hours	Lowell St. @ Mt. Auburn St. MG	Hours	Memorial Dr. @ Hawthorne St. MG	Hours	Edwin Land Blvd. @ Binney St. MG	Hours
11/1/2022	0.00	0.00	0.00	0.00	0.00	0.00	0.00	0.00	0.00	0.00	0.00	0.00	0.00	0.00	0.00
11/2/2022	0.00	0.00	0.00	0.00	0.00	0.00	0.00	0.00	0.00	0.00	0.00	0.00	0.00	0.00	0.00
11/3/2022	0.00	0.00	0.00	0.00	0.00	0.00	0.00	0.00	0.00	0.00	0.00	0.00	0.00	0.00	0.00
11/4/2022	0.00	0.00	0.00	0.00	0.00	0.00	0.00	0.00	0.00	0.00	0.00	0.00	0.00	0.00	0.00
11/5/2022	0.00	0.00	0.00	0.00	0.00	0.00	0.00	0.00	0.00	0.00	0.00	0.00	0.00	0.00	0.00
11/6/2022	0.00	0.00	0.00	0.00	0.00	0.00	0.00	0.00	0.00	0.00	0.00	0.00	0.00	0.00	0.00
11/7/2022	0.00	0.00	0.00	0.00	0.00	0.00	0.00	0.00	0.00	0.00	0.00	0.00	0.00	0.00	0.00
11/8/2022	0.01	0.00	0.00	0.00	0.00	0.00	0.00	0.00	0.00	0.00	0.00	0.00	0.00	0.00	0.00
11/9/2022	0.00	0.00	0.00	0.00	0.00	0.00	0.00	0.00	0.00	0.00	0.00	0.00	0.00	0.00	0.00
11/10/2022	0.00	0.00	0.00	0.00	0.00	0.00	0.00	0.00	0.00	0.00	0.00	0.00	0.00	0.00	0.00
11/11/2022	0.29	0.00	0.00	0.00	0.00	0.00	0.00	0.00	0.00	0.00	0.00	0.00	0.00	0.00	0.00
11/12/2022	0.12	0.00	0.00	0.00	0.00	0.00	0.00	0.00	0.00	0.00	0.00	0.00	0.00	0.00	0.00
11/13/2022	0.16	0.00	0.00	0.00	0.00	0.00	0.00	0.00	0.00	0.00	0.00	0.00	0.00	0.00	0.00
11/14/2022	0.00	0.00	0.00	0.00	0.00	0.00	0.00	0.00	0.00	0.00	0.00	0.00	0.00	0.00	0.00
11/15/2022	0.01	0.00	0.00	0.00	0.00	0.00	0.00	0.00	0.00	0.00	0.00	0.00	0.00	0.00	0.00
11/16/2022	0.93	0.00	0.00	0.00	0.00	0.02	0.33	0.00	0.00	0.00	0.00	0.00	0.00	0.00	0.00
11/17/2022	0.00	0.00	0.00	0.00	0.00	0.00	0.00	0.00	0.00	0.00	0.00	0.00	0.00	0.00	0.00
11/18/2022	0.00	0.00	0.00	0.00	0.00	0.00	0.00	0.00	0.00	0.00	0.00	0.00	0.00	0.00	0.00
11/19/2022	0.00	0.00	0.00	0.00	0.00	0.00	0.00	0.00	0.00	0.00	0.00	0.00	0.00	0.00	0.00
11/20/2022	0.00	0.00	0.00	0.00	0.00	0.00	0.00	0.00	0.00	0.00	0.00	0.00	0.00	0.00	0.00
11/21/2022	0.00	0.00	0.00	0.00	0.00	0.00	0.00	0.00	0.00	0.00	0.00	0.00	0.00	0.00	0.00
11/22/2022	0.00	0.00	0.00	0.00	0.00	0.00	0.00	0.00	0.00	0.00	0.00	0.00	0.00	0.00	0.00
11/23/2022	0.00	0.00	0.00	0.00	0.00	0.00	0.00	0.00	0.00	0.00	0.00	0.00	0.00	0.00	0.00
11/24/2022	0.00	0.00	0.00	0.00	0.00	0.00	0.00	0.00	0.00	0.00	0.00	0.00	0.00	0.00	0.00
11/25/2022	0.00	0.00	0.00	0.00	0.00	0.00	0.00	0.00	0.00	0.00	0.00	0.00	0.00	0.00	0.00
11/26/2022	0.00	0.00	0.00	0.00	0.00	0.00	0.00	0.00	0.00	0.00	0.00	0.00	0.00	0.00	0.00
11/27/2022	0.59	0.00	0.00	0.00	0.00	0.00	0.00	0.00	0.00	0.00	0.00	0.00	0.00	0.00	0.00
11/28/2022	0.00	0.00	0.00	0.00	0.00	0.00	0.00	0.00	0.00	0.00	0.00	0.00	0.00	0.00	0.00
11/29/2022	0.00	0.00	0.00	0.00	0.00	0.00	0.00	0.00	0.00	0.00	0.00	0.00	0.00	0.00	0.00
11/30/2022	0.82	0.00	0.00	0.00	0.00	0.09	0.17	0.00	0.00	0.00	0.00	0.00	0.00	0.00	0.00
TOTAL	2.93	0.00	0.00	0.00	0.00	0.11	0.50	0.00	0.00	0.00	0.00	0.00	0.00	0.00	0.00

* CSO Volumes and durations calculated from meter data

2022 Daily Rainfall and Combined Sewer Overflow Volumes

Date	Rainfall	Alewife Brook								Charles River					
		CAM001		CAM002		CAM401A*		CAM401B		CAM005		CAM007		CAM017*	
	Hybrid (CDPW+USGS Brookline) in	Foch St. @ Alewife Brook Pkwy. MG	Hours	Mass. Ave. @ Alewife Brook Pkwy. MG	Hours	Sherman St. @ B&M Railroad MG	Hours	Mass Ave./Columbus Ave. @ Alewife MG	Hours	Lowell St. @ Mt. Auburn St. MG	Hours	Memorial Dr. @ Hawthorne St. MG	Hours	Edwin Land Blvd. @ Binney St. MG	Hours
12/1/2022	0.00	0.00	0.00	0.00	0.00	0.00	0.00	0.00	0.00	0.00	0.00	0.00	0.00	0.00	0.00
12/2/2022	0.00	0.00	0.00	0.00	0.00	0.00	0.00	0.00	0.00	0.00	0.00	0.00	0.00	0.00	0.00
12/3/2022	0.21	0.00	0.00	0.00	0.00	0.00	0.00	0.00	0.00	0.00	0.00	0.00	0.00	0.00	0.00
12/4/2022	0.00	0.00	0.00	0.00	0.00	0.00	0.00	0.00	0.00	0.00	0.00	0.00	0.00	0.00	0.00
12/5/2022	0.00	0.00	0.00	0.00	0.00	0.00	0.00	0.00	0.00	0.00	0.00	0.00	0.00	0.00	0.00
12/6/2022	0.06	0.00	0.00	0.00	0.00	0.00	0.00	0.00	0.00	0.00	0.00	0.00	0.00	0.00	0.00
12/7/2022	0.71	0.00	0.00	0.00	0.00	0.00	0.00	0.00	0.00	0.00	0.00	0.00	0.00	0.00	0.00
12/8/2022	0.00	0.00	0.00	0.00	0.00	0.00	0.00	0.00	0.00	0.00	0.00	0.00	0.00	0.00	0.00
12/9/2022	0.00	0.00	0.00	0.00	0.00	0.00	0.00	0.00	0.00	0.00	0.00	0.00	0.00	0.00	0.00
12/10/2022	0.00	0.00	0.00	0.00	0.00	0.00	0.00	0.00	0.00	0.00	0.00	0.00	0.00	0.00	0.00
12/11/2022	0.00	0.00	0.00	0.00	0.00	0.00	0.00	0.00	0.00	0.00	0.00	0.00	0.00	0.00	0.00
12/12/2022	0.00	0.00	0.00	0.00	0.00	0.00	0.00	0.00	0.00	0.00	0.00	0.00	0.00	0.00	0.00
12/13/2022	0.00	0.00	0.00	0.00	0.00	0.00	0.00	0.00	0.00	0.00	0.00	0.00	0.00	0.00	0.00
12/14/2022	0.00	0.00	0.00	0.00	0.00	0.00	0.00	0.00	0.00	0.00	0.00	0.00	0.00	0.00	0.00
12/15/2022	0.05	0.00	0.00	0.00	0.00	0.00	0.00	0.00	0.00	0.00	0.00	0.00	0.00	0.00	0.00
12/16/2022	1.60	0.00	0.00	0.00	0.00	0.00	0.00	0.00	0.00	0.00	0.00	0.00	0.00	0.00	0.00
12/17/2022	0.15	0.00	0.00	0.00	0.00	0.00	0.00	0.00	0.00	0.00	0.00	0.00	0.00	0.00	0.00
12/18/2022	0.00	0.00	0.00	0.00	0.00	0.00	0.00	0.00	0.00	0.00	0.00	0.00	0.00	0.00	0.00
12/19/2022	0.00	0.00	0.00	0.00	0.00	0.00	0.00	0.00	0.00	0.00	0.00	0.00	0.00	0.00	0.00
12/20/2022	0.00	0.00	0.00	0.00	0.00	0.00	0.00	0.00	0.00	0.00	0.00	0.00	0.00	0.00	0.00
12/21/2022	0.00	0.00	0.00	0.00	0.00	0.00	0.00	0.00	0.00	0.00	0.00	0.00	0.00	0.00	0.00
12/22/2022	0.24	0.00	0.00	0.00	0.00	0.00	0.00	0.00	0.00	0.00	0.00	0.00	0.00	0.00	0.00
12/23/2022	1.49	0.00	0.00	0.00	0.00	0.01	0.33	0.00	0.00	0.00	0.00	0.00	0.00	0.00	0.00
12/24/2022	0.00	0.00	0.00	0.00	0.00	0.00	0.00	0.00	0.00	0.00	0.00	0.00	0.00	0.00	0.00
12/25/2022	0.00	0.00	0.00	0.00	0.00	0.00	0.00	0.00	0.00	0.00	0.00	0.00	0.00	0.00	0.00
12/26/2022	0.00	0.00	0.00	0.00	0.00	0.00	0.00	0.00	0.00	0.00	0.00	0.00	0.00	0.00	0.00
12/27/2022	0.00	0.00	0.00	0.00	0.00	0.00	0.00	0.00	0.00	0.00	0.00	0.00	0.00	0.00	0.00
12/28/2022	0.00	0.00	0.00	0.00	0.00	0.00	0.00	0.00	0.00	0.00	0.00	0.00	0.00	0.00	0.00
12/29/2022	0.00	0.00	0.00	0.00	0.00	0.00	0.00	0.00	0.00	0.00	0.00	0.00	0.00	0.00	0.00
12/30/2022	0.00	0.00	0.00	0.00	0.00	0.00	0.00	0.00	0.00	0.00	0.00	0.00	0.00	0.00	0.00
12/31/2022	0.33	0.00	0.00	0.00	0.00	0.00	0.00	0.00	0.00	0.00	0.00	0.00	0.00	0.00	0.00
TOTAL	4.84	0.00	0.00	0.00	0.00	0.01	0.33	0.00	0.00	0.00	0.00	0.00	0.00	0.00	0.00
Total Year	28.67	0.00	0.00	0.00	0.00	0.47	2.39	0.00	0.00	0.16	2.75	0.00	0.00	0.00	0.00

* CSO Volumes and durations calculated from meter data

APPENDIX III

CSO NOTIFICATIONS

 An official website of the United States government
[Here's how you know](#)

COMBINED SEWER OVERFLOW REPORTING

State regulations ([314 CMR 16.00](#)) require the City of Cambridge to notify the public when certain events occur that result in untreated wastewater being released into surface water--a river or stream. Notifications are posted below and also sent out via email. All Data are preliminary and subject to change. [Subscribe to Cambridge's Combined Sewer Overflow \(CSO\) Alerts.](#)

[City of Cambridge Public Notification Plan](#)

The City of Cambridge is submitting to the Massachusetts Department of Environmental Protection (MassDEP) a Public Notification Plan describing how it will comply with the requirements of An Act Promoting Awareness of Sewage in Public Waters, signed into law in 2021. Written comments can be submitted until February 24, 2023 to massdep.sewagenotification@mass.gov (email preferred) or by mail to 100 Cambridge St, Suite 900 Boston, MA 02114. Comments can also be emailed to the City of Cambridge to csodata@cambridgema.gov

Public Notices on the City of Cambridge Public Notification Plan (PDF*)

[ግርኛ Amharic](#)

[नेपाली Nepali](#)

[العربية Arabic](#)

[Português, Portuguese](#)

[中文 Chinese](#)

[Русский Russian](#)

[English](#)

[Español, Spanish](#)

[Haitian Creole](#)

[Tiếng Việt, Vietnamese](#)

*PDF files require free PDF reader available from [Adobe Systems](#).

A combined sewer overflow (CSO) occurs when a large storm overwhelms the combined sewerage system causing rainwater to mix with wastewater and discharge to a nearby water body. This relief measure prevents sewage backups into homes and businesses. Cambridge owns combined sewer outfalls that discharge to the Charles River and Alewife Brook. When a CSO occurs at a Cambridge-owned outfall, there will be a notification displayed in the table below.

The Massachusetts Water Resource Authority ([MWRA](#)) and the cities of [Boston](#), [Chelsea](#) and [Somerville](#) manage their own combined sewer outfalls, including CSO reporting. These communities must be contacted directly for information regarding their CSO discharges. To see where all CSO outfalls are located, download this [MWRA map](#) of MWRA and community CSO sites.

PUBLIC HEALTH NOTIFICATIONS

State regulations require local public health departments to provide notice to the public when these discharges may create a risk to public health, including when a discharge lasts for two or more hours. Public health warnings related to sewage discharges will be posted on the [Cambridge Public Health Departments News & Events webpage](#).

Public health officials recommend avoiding contact with water bodies during rainstorms and for 48 hours afterwards, as there may be increased health risks due to bacteria or other pollutants associated with urban stormwater runoff and CSO discharges. To see what Cambridge is doing to address pollutants from stormwater runoff please visit our [stormwater management](#) website and learn how you can also help reduce stormwater pollution. For more information on water quality data in the Charles River and the Mystic River please see: [Charles River Watershed Association](#) Water quality Reports & Data and the [Mystic River Watershed Association](#) Mystic Daily Boating Advisory.

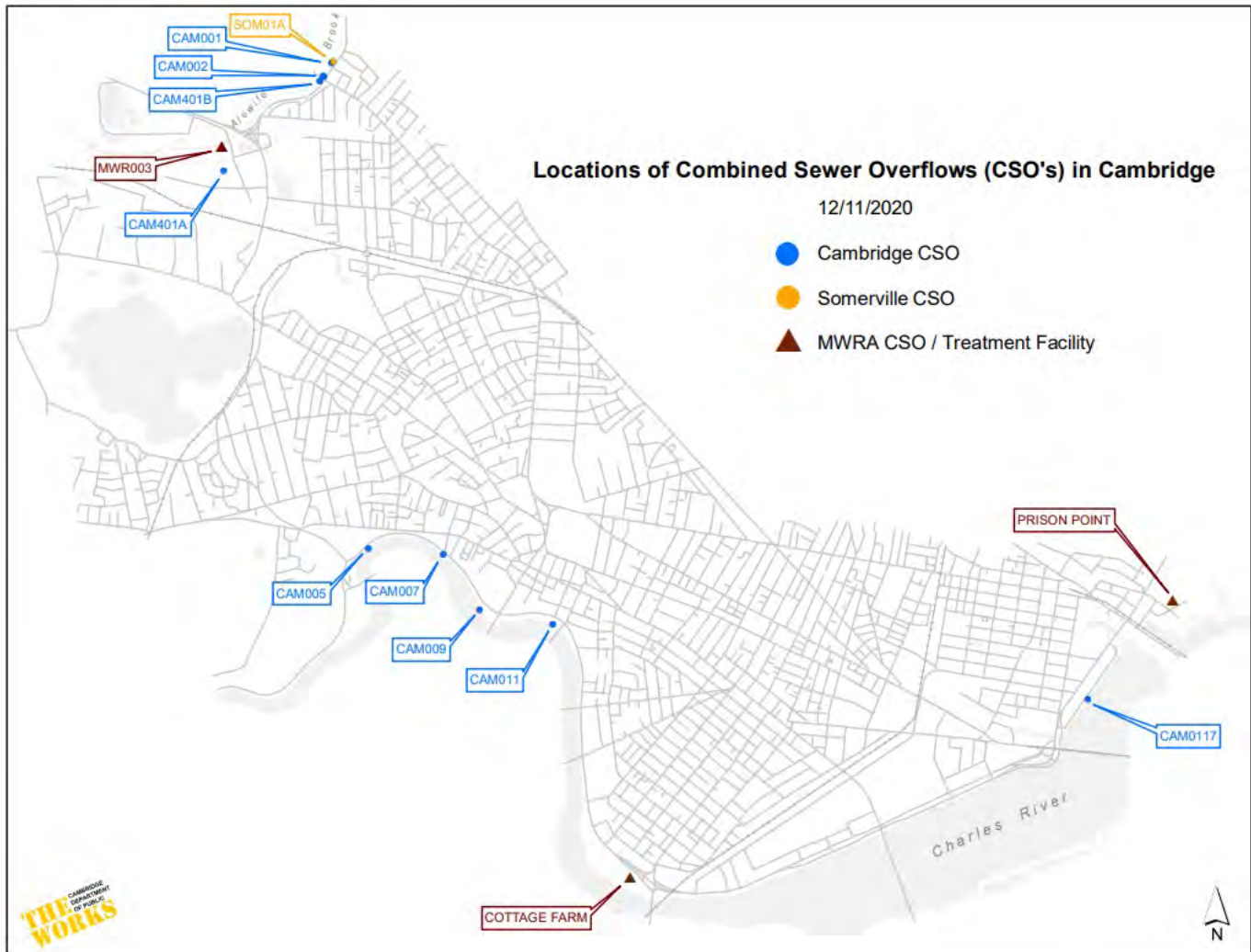

To view a full-size version of this map, [click here](#).

Description of CSO Locations and Potentially Affected Areas

CAM001: Alewife Brook, discharges downstream of Massachusetts Ave Bridge across from Murry Hill Road.

CAM002: Alewife Brook, discharges downstream of Massachusetts Ave Bridge

CAM401A: Alewife Brook, discharges upstream of the confluence with the Little River and upstream of the Route 2 Bridge.

CAM401B: Alewife Brook, discharges upstream of the Massachusetts Ave Bridge.

CAM005: Charles River, discharges downstream of the Eliot Bridge across from Mount Auburn Hospital.

CAM007: Charles River, discharges downstream of the Eliot Bridge across from Hawthorne Street.

CAM009: Charles River, discharges upstream of the Anderson Bridge (temporarily closed).

CAM011: Charles River, discharges upstream of the Weeks Footbridge (temporarily closed).

CAM017: Charles River, discharges downstream of the Longfellow Bridge across from Front Park.

Note: The CSO discharge table below provides details of recent discharges. Data for CSOs is preliminary and subject to change. Discharge duration and volume are estimates and are subject to calculation limitations, including meter data reliability, unmonitored downstream conditions such as river level, and MWRA system operations. See the following links for information on past CSO [annual reporting](#) and yearly [CSO discharge summaries](#). Annual reporting data for each calendar year will be published by April 30 of the following year. Updated/revised data is indicated by ().

Event Date	CSO Number	Outfall Location	Potentially Affected Area	Start Time	Stop Time	Duration	Volume (million gallons)	Event Rainfall (inches)	Noti
03.02.2023	CAM401A	Alewife Brook	Upstream of the confluence with the Little River and upstream of the Route 2 Bridge	7:21 am	9:13 am	1 hour, 52 minutes	0.78 MG (estimated average of last three years)	TBD	Alert
01.26.2023 (Rev)	CAM401A	Alewife Brook	Upstream of the confluence with the Little River and upstream of the Route 2 Bridge	2:05 am (2:15 am)	4:15 am	2 hours, 10 minutes (2 hours)	0.78 MG (estimated average of last three years) (0.09 MG)	1.08"	Alert
12.23.2022 (Rev)	CAM401A	Alewife Brook	Upstream of the confluence with the Little River and upstream of the Route 2 Bridge	12:55 am (12:59 am)	1:36 am (1:19 am)	41 minutes (20 minutes)	0.78 MG (estimated average of last three years) (< 0.01 MG)	1.85" (1.73")	Alert
11.30.2022 (Rev)	CAM401A	Alewife Brook	Upstream of the confluence with the Little River and upstream of the Route 2 Bridge	7:20 pm (7:19 pm)	7:36 pm (7:39 pm)	16 minutes (20 minutes)	0.78 MG (estimated average of last three years) (0.09MG)	0.73 (0.82")	Alert
11.16.2022	CAM401A	Alewife Brook	Upstream of the confluence with the Little River and upstream of the Route 2 Bridge	(7:11 am)	(7:41 am)	30 minutes	(<0.01 MG)	(0.94")	Not issued
10.18.2022	CAM401A	Alewife Brook	Upstream of the confluence with the Little River and upstream of the Route 2 Bridge	(2:25 am)	(2:35 am)	(10 minutes)	(<0.01 MG)	(0.35")	Not issued
10.14.2022 (Rev)	CAM005	Charles River	Downstream of the Eliot Bridge, across from Munt	9:10 am (9:15 am)	10:55 am (9:30 am)	105 minutes	0.40 MG (estimated average of	1.83"	Alert

			Auburn Hospital			(15 minutes)	last three years) (0.03 MG)		
10.14.2022 (Rev)	CAM401A	Alewife Brook	Upstream of the confluence with the Little River and upstream of the Route 2 Bridge	9:05 am (9:22 am)	10:05 am (9:52 am)	60 minutes (30 minutes)	0.78 (estimated average of last three years) (0.19 MG)	1.83" (1.70")	Alert
09.19.2022	CAM401A	Alewife Brook	Upstream of the confluence with the Little River and upstream of the Route 2 Bridge	(9:35 pm)	(9:45 pm)	(10 minutes)	(0.01 MG)	(0.29")	Not issued
08.26.2022 (Rev)	CAM401A	Alewife Brook	Upstream of the confluence with the Little River and upstream of the Route 2 Bridge	4:40 pm (4:37 pm)	4:55 pm (4:57 pm)	15 minutes (20 minutes)	0.78 (estimated average of last three years) (0.12 MG)	0.50"	Alert
08.26.2022 (Rev)	CAM005	Charles River	Downstream of the Eliot Bridge, across from Mount Auburn Hospital	(4:45 pm)	(5:00 pm)	(15 minutes)	(0.01 MG)	0.50"	Not issued
08.05.2022	CAM401A	Alewife Brook	Upstream of the confluence with the Little River and upstream of the Route 2 Bridge	(4:44 pm)	(4:54 pm)	(10 minutes)	(<0.01 MG)	(0.10")	Not issued
06.27.2022 (Rev)	CAM005	Charles River	Downstream of the Eliot Bridge, across from Mount Auburn Hospital	2:05 pm (2:00 pm)	2:15 pm	15 minutes	0.01	0.79"	Alert
04.19.2022	CAM005	Charles River	Downstream of the Eliot Bridge, across from Mount	4:35 am (4:00 am rev)	6:00 am	120 minutes	0.11	1.02"	

			Auburn Hospital						
02.04.2022	CAM401A	Alewife Brook	Upstream of the confluence with the Little River and upstream of the Route 2 Bridge	(7:23 am)	(7:33 am)	10 minutes)	(<0.01)	(1.33")	
01.17.2022	CAM401A	Alewife Brook	Upstream of the confluence with the Little River and upstream of the Route 2 Bridge	7:40 am - No activation (7:49 am)	No Spill (7:59 am)	No Spill (10 minutes)	No Spill (<0.01)	0.98"	
11.12.2021	CAM401A	Alewife Brook	Upstream of the confluence with the Little River and upstream of the Route 2 Bridge	4:05 pm	4:50 pm	45 minutes	0.06	1.07"	
10.30.2021	CAM401B	Alewife Brook	Upstream of the Mass Ave Bridge	7:24 pm	7:39 pm	15 minutes	< 0.001	1.63"	
10.30.2021	CAM005	Charles River	Downstream of the Eliot Bridge, across from Mount Auburn Hospital	7:20 pm	7:50 pm	30 minutes	0.02	1.63"	
10.30.2021	CAM001	Alewife Brook	Downstream of the Massachusetts Ave Bridge across from Murray Hill Road	7:17 pm	7:22 pm	5 minutes	< 0.001	1.63"	
10.30.2021	CAM401A	Alewife Brook	Upstream of the confluence with the Little River and upstream of the Route 2 Bridge	7:05 pm	8:20 pm	75 minutes	0.23	1.63"	
10.26.2021	CAM401B	Alewife Brook	Upstream of the Mass Ave	7:09 am	7:39 am	30 minutes	0.27	1.43"	

APPENDIX IV

INITIALLY REPORTED AND FINAL CALCULATED CSO VOLUMES

CSO Volumes- Final vs Preliminary Reported

Outfall	Calculated From Final Meter Data			CDPW Website Reporting, Calculated From Preliminary Data		
	Date	VOLUME (MG)	Sensor Used	Date	VOLUME (MG)	Sensor Used
CAM401A	1/17/2022	<0.01	Smartcover Level Sensor	1/17/2022	No Spill	Smartcover Level Sensor
	2/4/2022	<0.01		2/4/2022	Not Reported	
	8/5/2022	<0.01		8/5/2022	<0.01	
	8/26/2022	0.12		8/26/2022	0.12	
	9/19/2022	0.01		9/19/2022	Not Reported	
	10/14/2022	0.19		10/14/2022	0.19	
	10/18/2022	<0.01		10/18/2022	Not Reported	
	11/16/2022	<0.01		11/16/2022	Not Reported	
	11/30/2022	0.09		11/30/2022	0.09	
	12/23/2022	<0.01		12/23/2022	<0.01	
	Total:	0.47		Total:	0.42	
CAM005	4/19/2022	0.11	CDPW Regulator Sensor	4/19/2022	0.11	CDPW Level Sensor- SCADA Output
	6/27/2022	0.01		6/27/2022	0.01	
	8/26/2022	0.01		8/26/2022	0.01	
	10/14/2022	0.03		10/14/2022	0.03	
	Total	0.16		Total	0.16	

APPENDIX V

PLAN AND PROFILE SCHEMATICS OF CSO REGULATORS

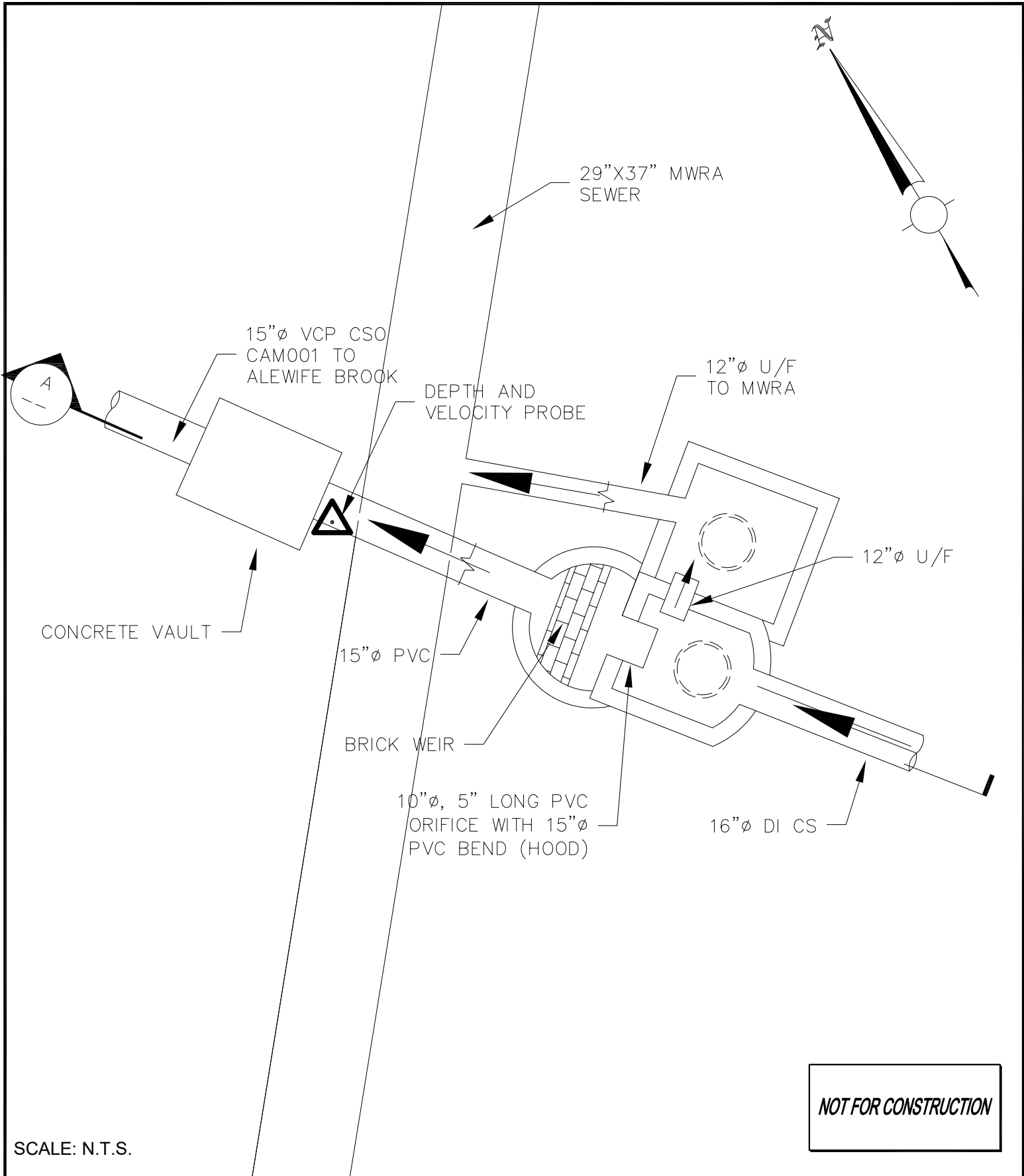

**CSO REGULATOR STRUCTURE
CAM001 PLAN**

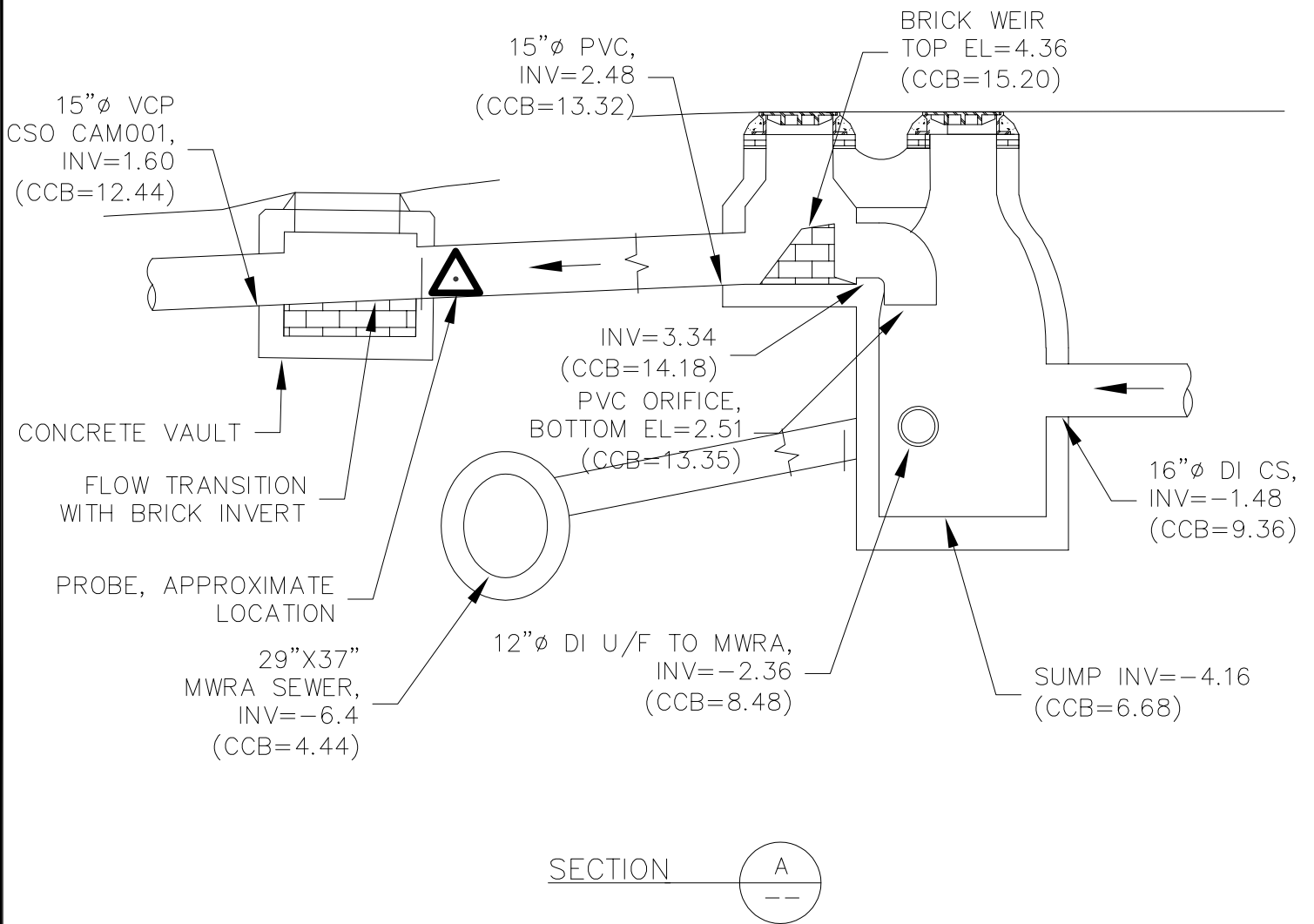

NOT FOR CONSTRUCTION

SCALE: N.T.S.

**CSO REGULATOR STRUCTURE
CAM001 PROFILE**

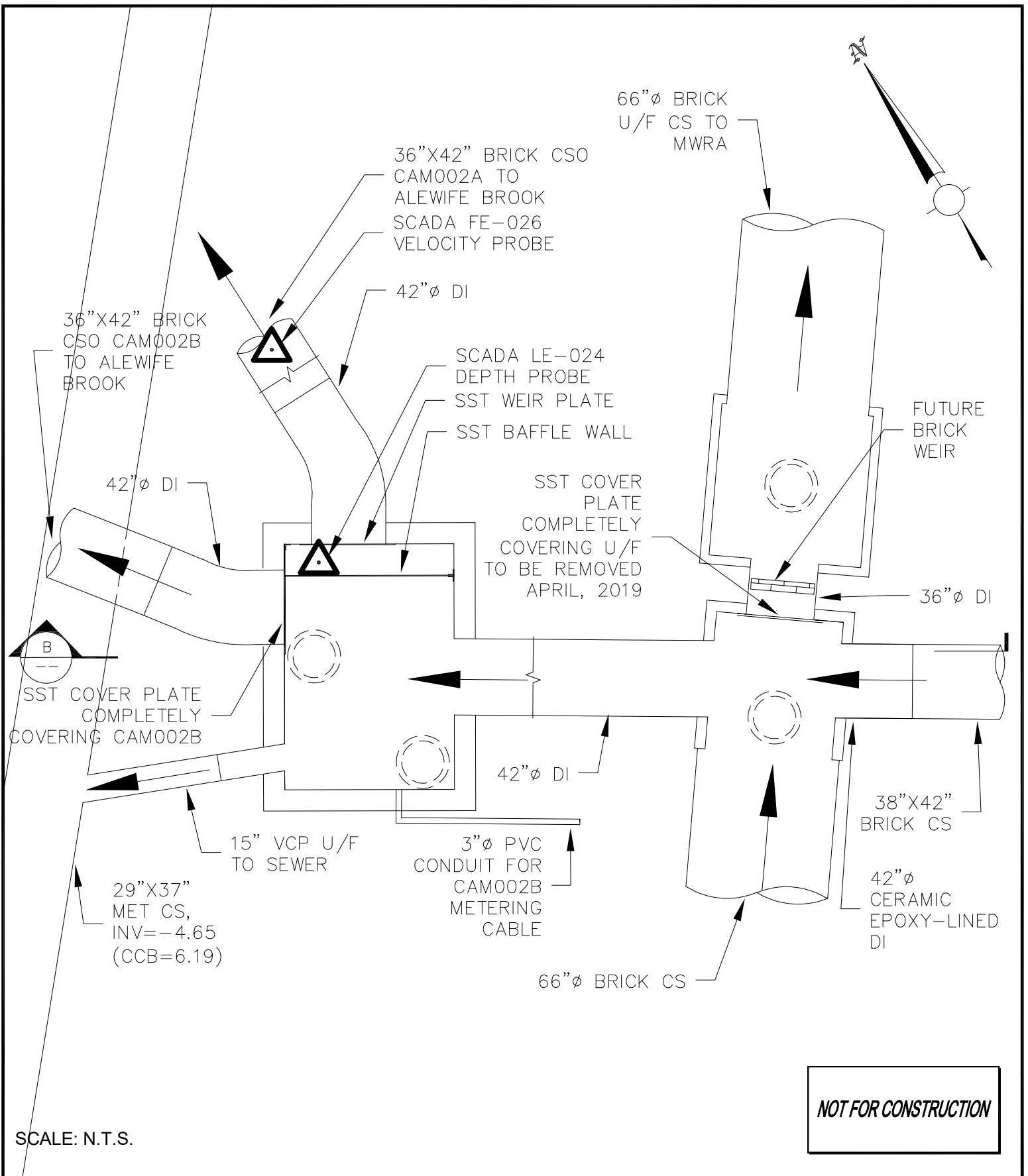

SCALE: N.T.S.

NOT FOR CONSTRUCTION

CSO REGULATOR STRUCTURE CAM002 PLAN

NOTES:

- 1) VELOCITY PROBE IN CAM002A, APPROXIMATELY LOCATED AT PIPE BOTTOM 13' DOWNSTREAM FROM WEIR

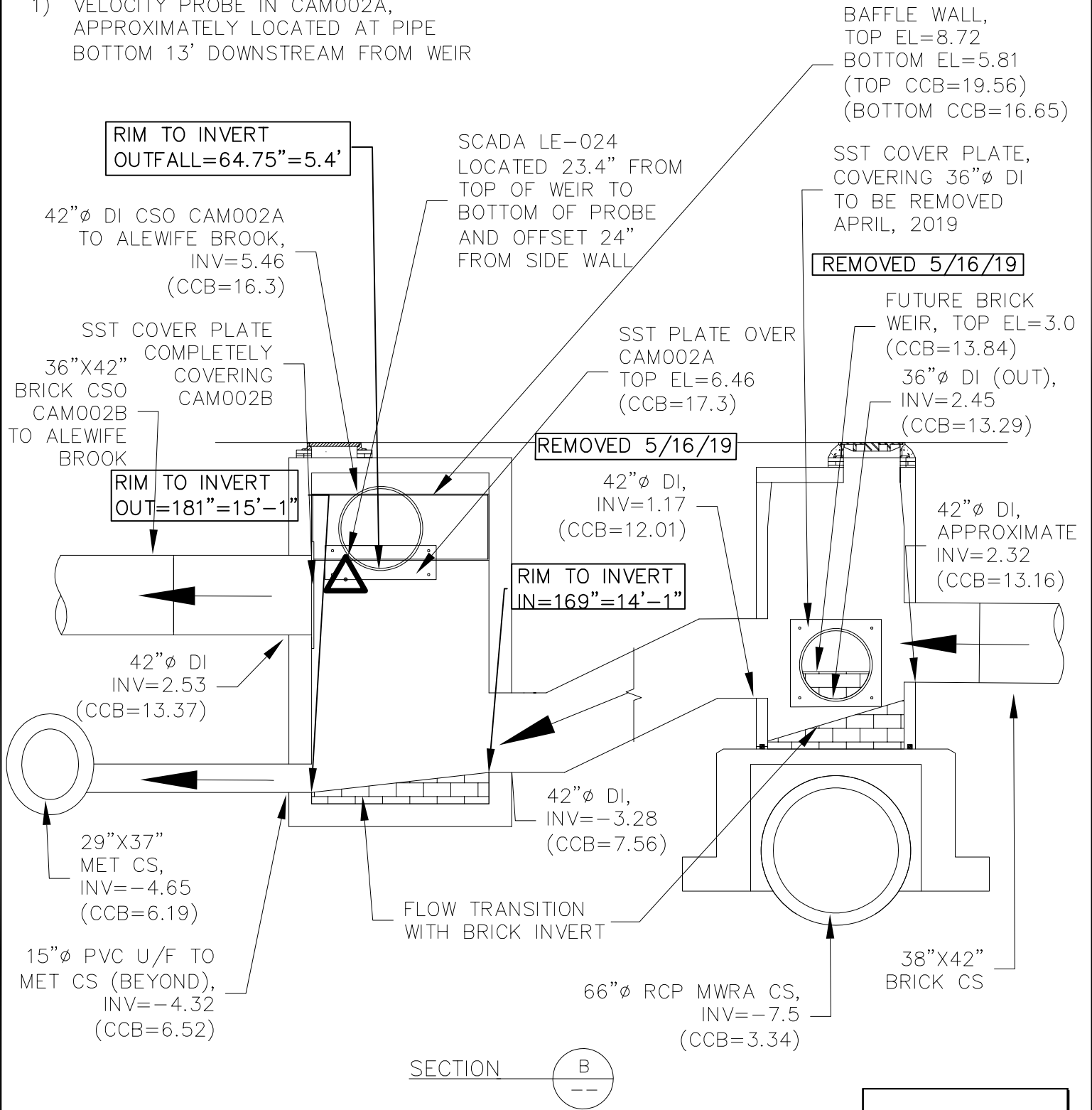

REMOVED 5/16/19

REMOVED 5/16/19

NOT FOR CONSTRUCTION



SCALE: N.T.S.

**CSO REGULATOR STRUCTURE
CAM002 PROFILE**

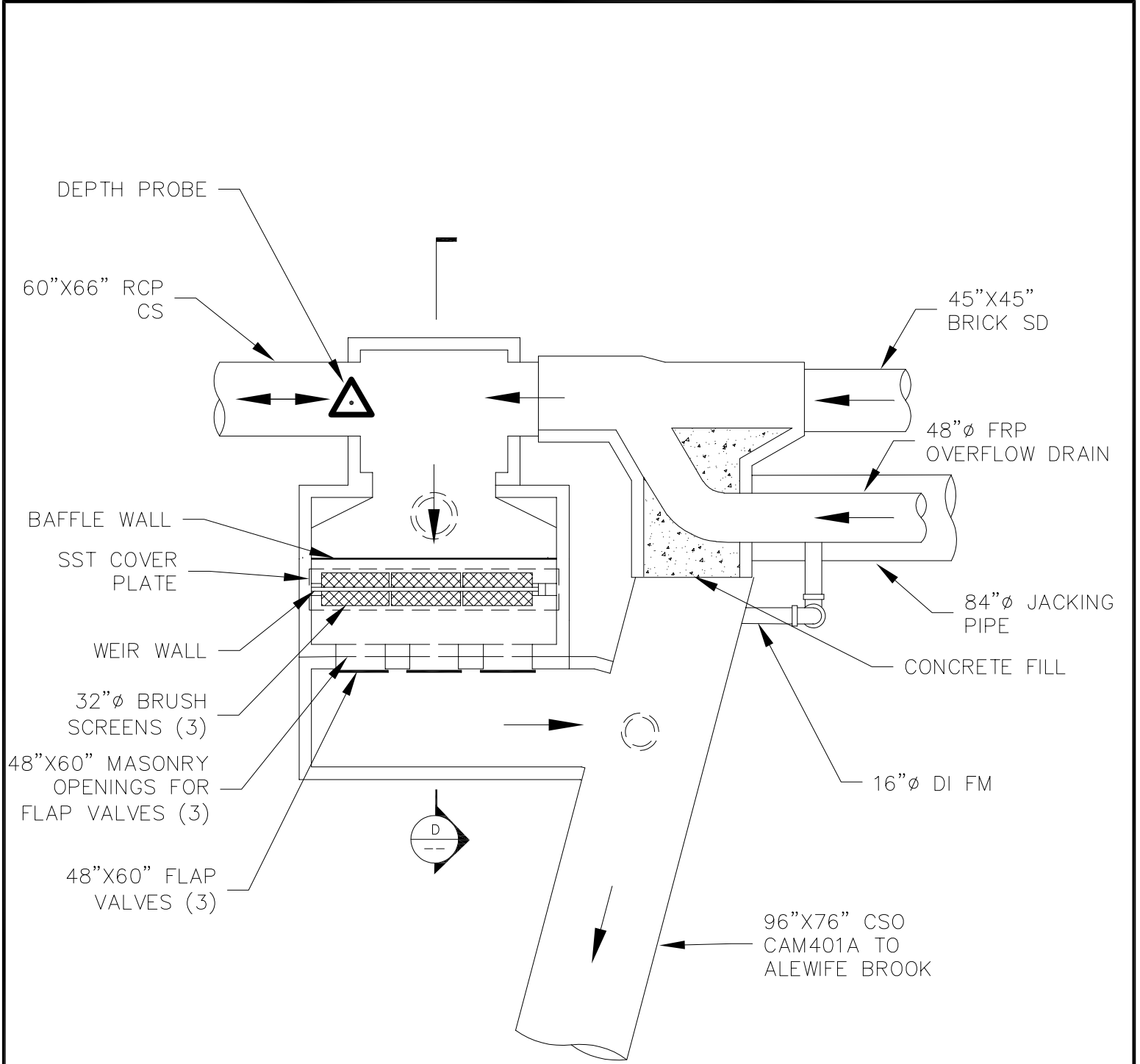

DEPTH PROBE

60"X66" RCP
CS

45"X45"
BRICK SD

48"Ø FRP
OVERFLOW DRAIN

BAFFLE WALL

SST COVER
PLATE

84"Ø JACKING
PIPE

WEIR WALL

CONCRETE FILL

32"Ø BRUSH
SCREENS (3)

48"X60" MASONRY
OPENINGS FOR
FLAP VALVES (3)

16"Ø DI FM

48"X60" FLAP
VALVES (3)

96"X76" CSO
CAM401A TO
ALEWIFE BROOK

NOT FOR CONSTRUCTION

SCALE: N.T.S.

**CSO REGULATOR STRUCTURE
CAM0401A PLAN**

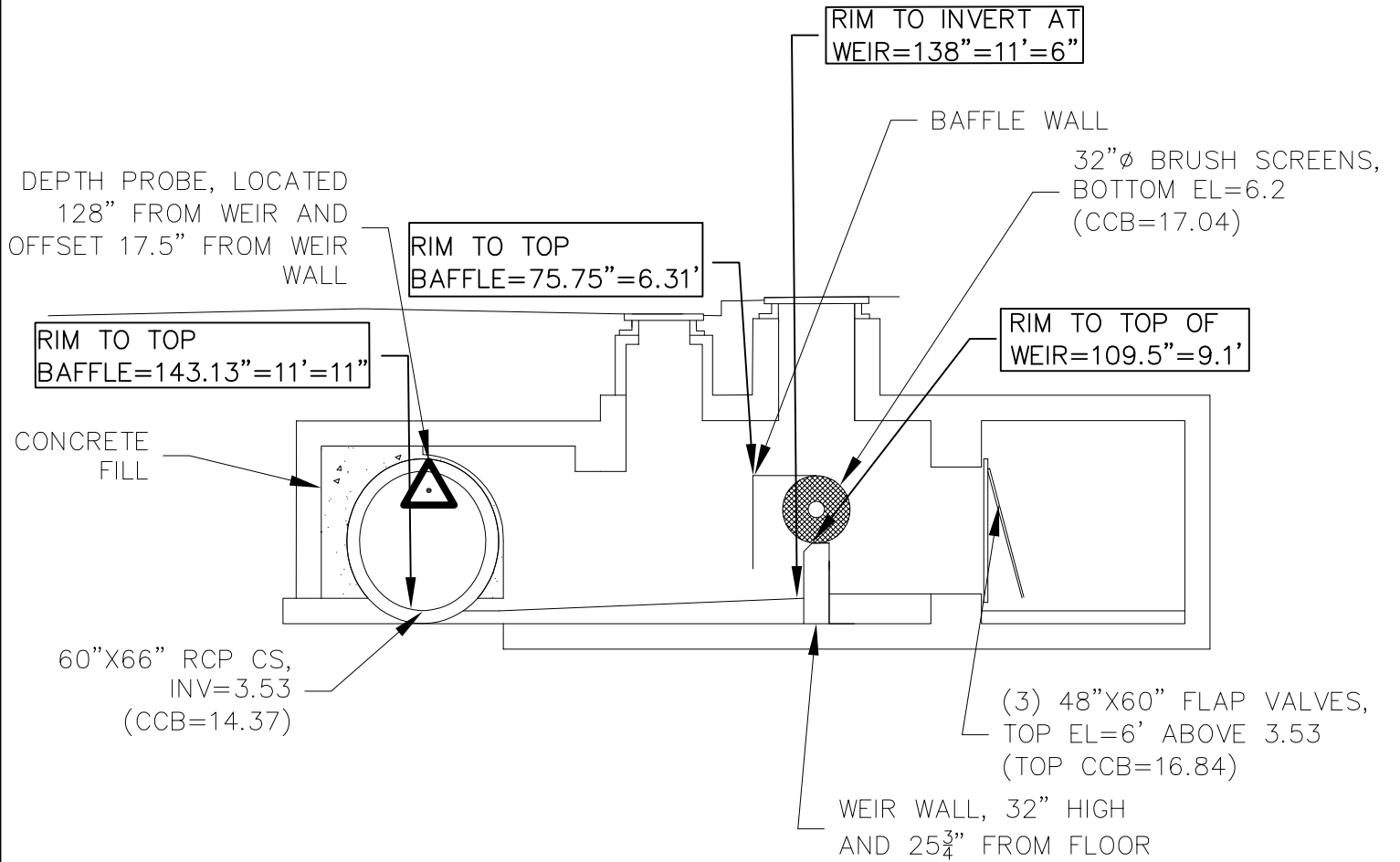

NOT FOR CONSTRUCTION

**CSO REGULATOR STRUCTURE
CAM401A PROFILE**

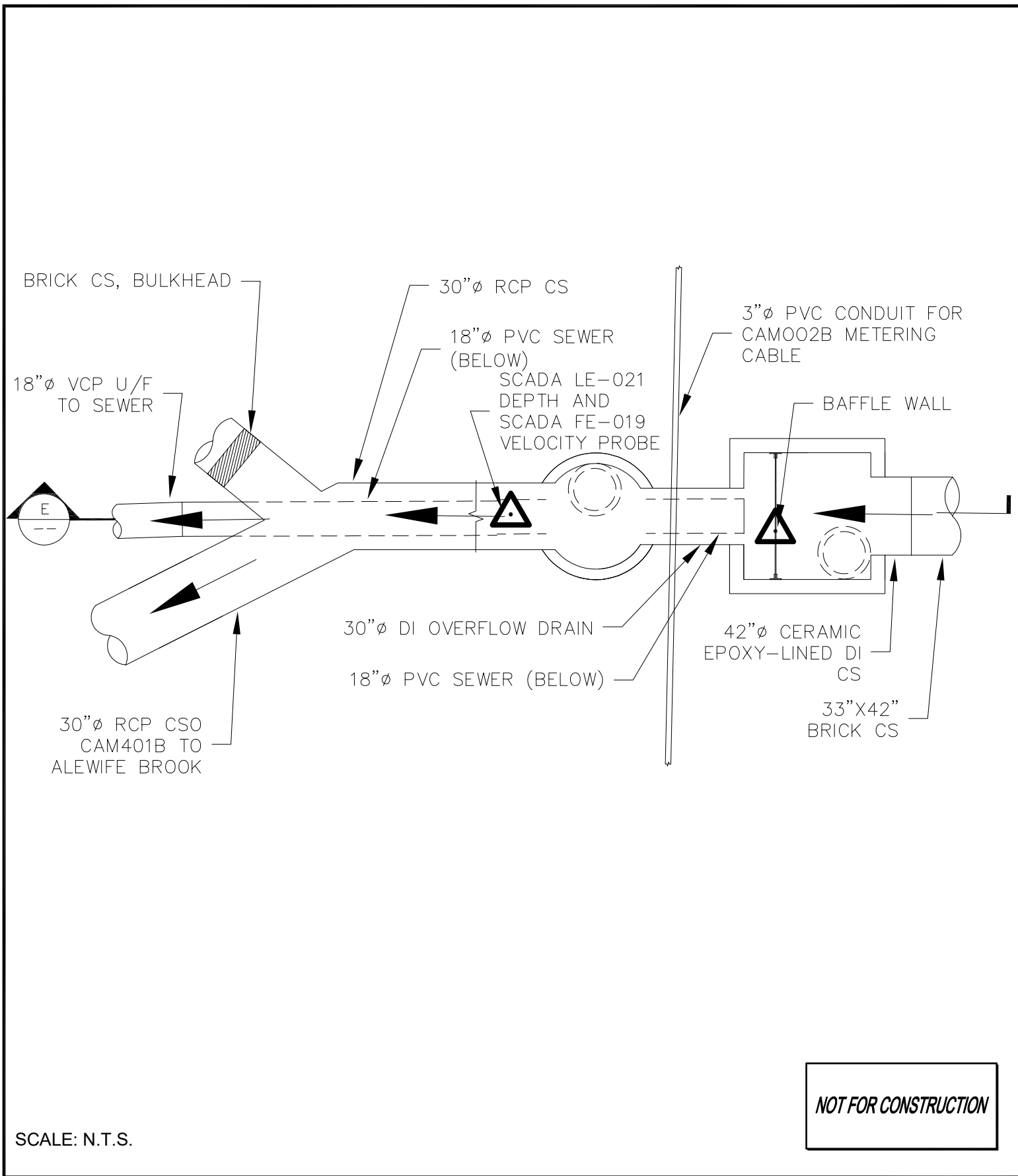

**CSO REGULATOR STRUCTURE
CAM401B PLAN**

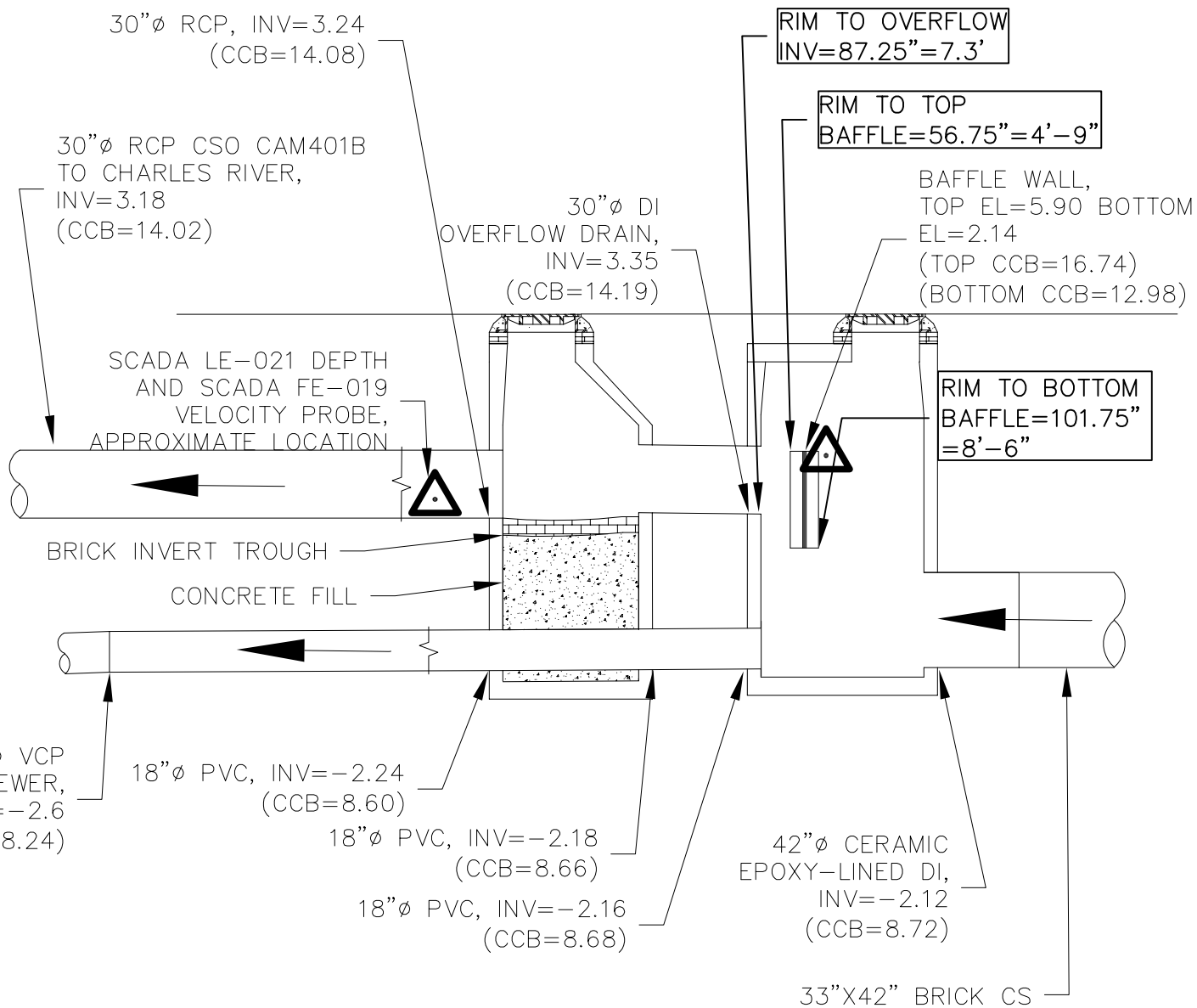

SECTION 

NOT FOR CONSTRUCTION

SCALE: N.T.S.

**CSO REGULATOR STRUCTURE
CAM401B PROFILE**

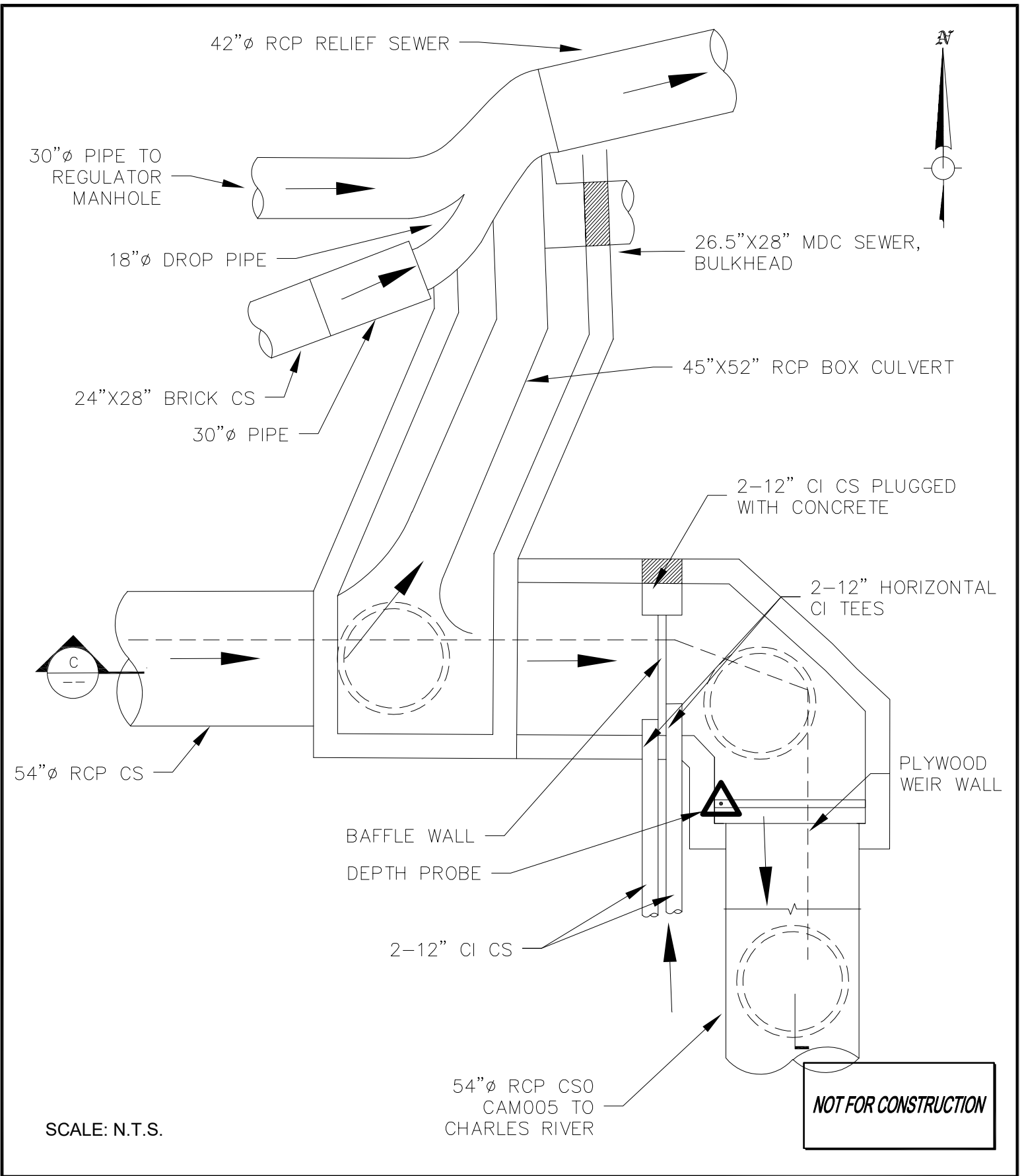

CSO REGULATOR STRUCTURE CAM005 PLAN

MH"A"RIM EL=
122.67" (MDC)

RIM TO WEIR TOP
MH"A"=171.25"=14.27'

RIM TO INVERT
MH"H'=211.75"=17'-8"

BAFFLE WALL,
BOTTOM EL=13.22
(CCB=24.06)

PLYWOOD WEIR WALL,
TOP EL=14.82*
BOTTOM EL=10.94*
(TOP CCB=25.66)
(BOTTOM CCB=21.78)

DEPTH PROBE,
LOCATED ON
WEIR WALL,
23.2" BELOW
TOP OF WEIR
WALL AND 5"
FROM WALL OF
CAM005

52"X45"RCP
BOX CULVERT

54"Ø RCP CS,
INV=10.94*
(CCB= 21.78)

54"Ø RCP CS,
INV=10.94*
(CCB=21.78)

SECTION



NOT FOR CONSTRUCTION

SCALE: N.T.S.

CSO REGULATOR STRUCTURE CAM005 PROFILE

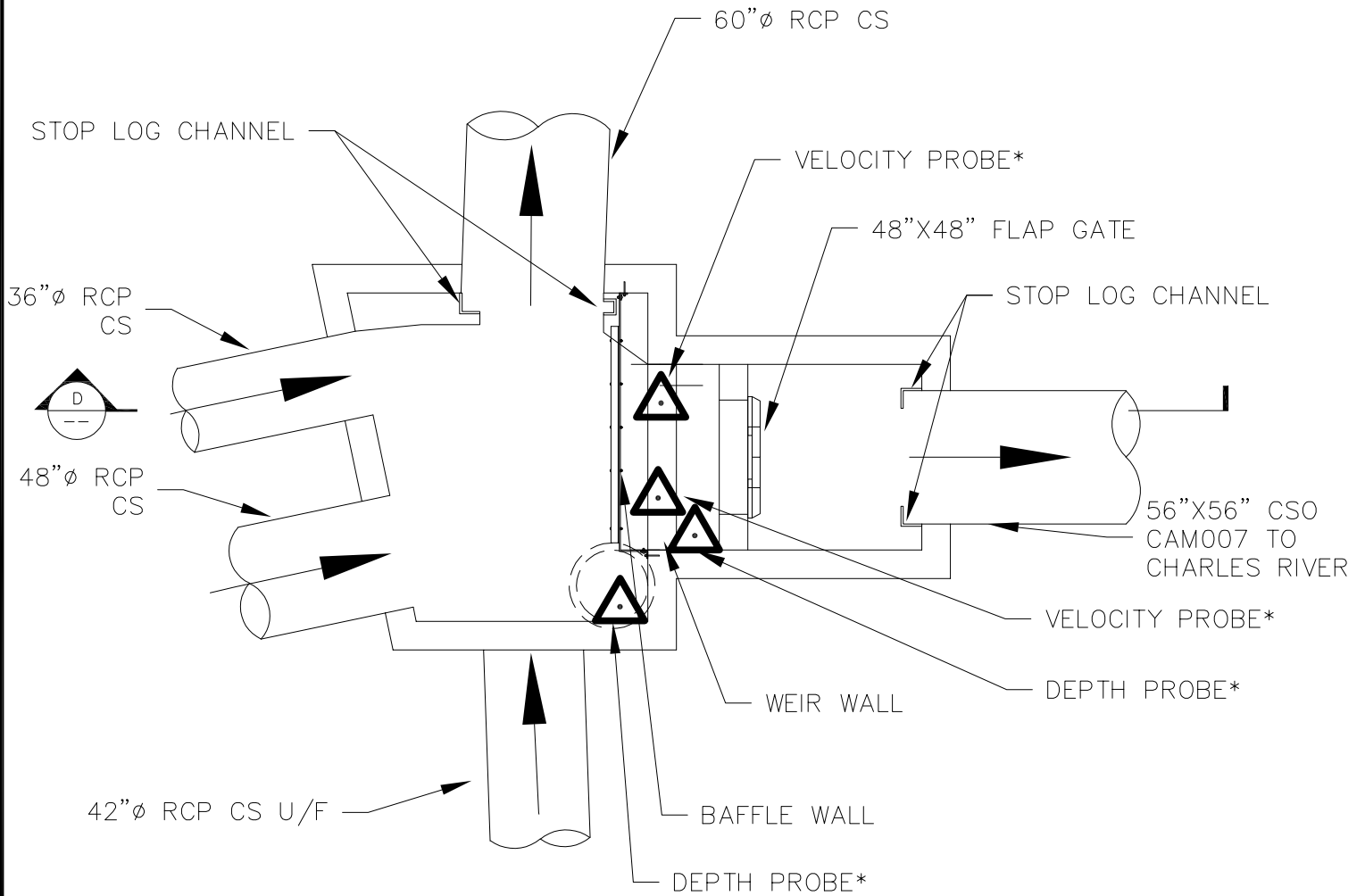

NOT FOR CONSTRUCTION

SCALE: N.T.S.

CSO REGULATOR STRUCTURE CAM007 PLAN

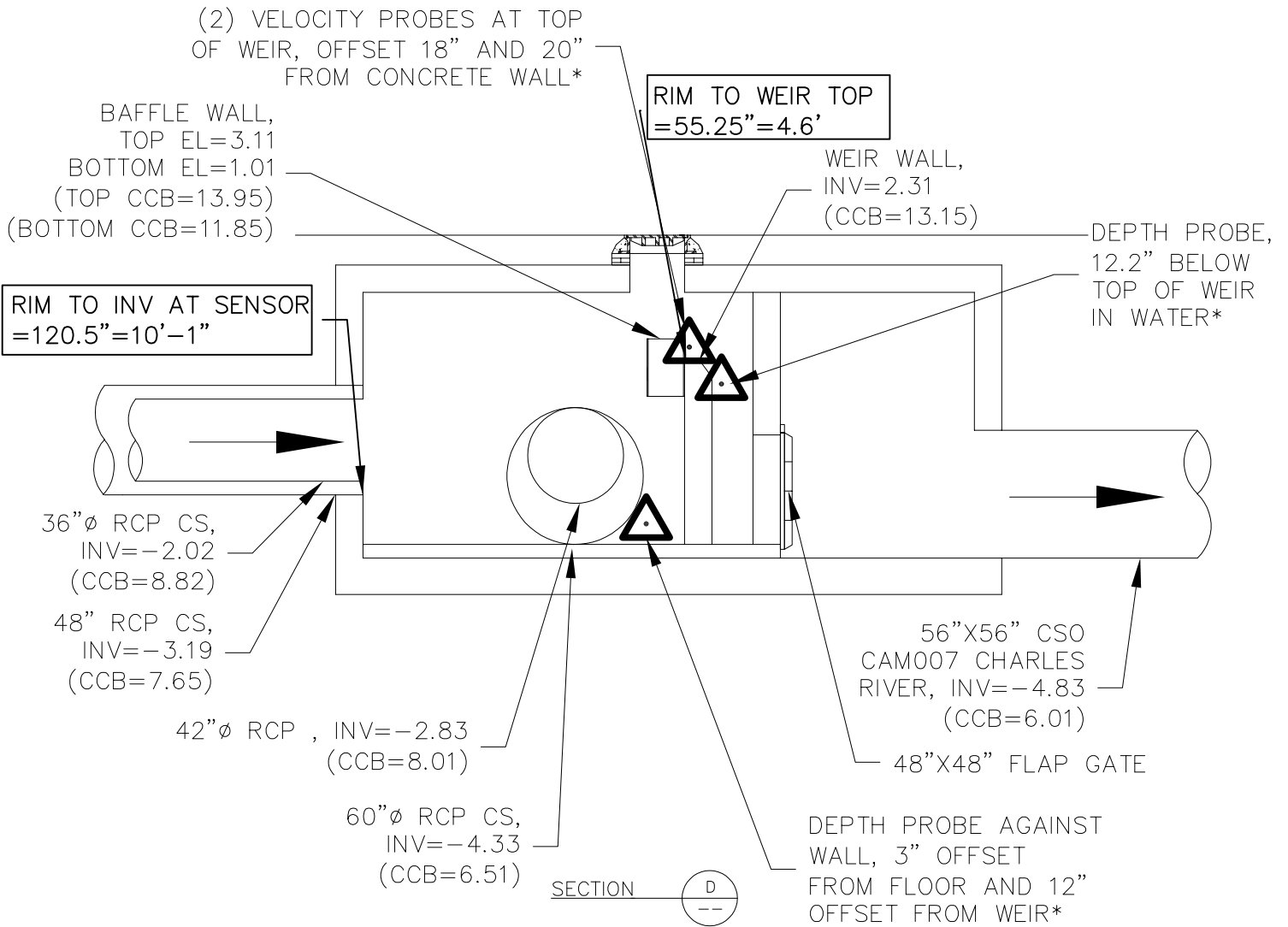

NOT FOR CONSTRUCTION

SCALE: N.T.S.

**CSO REGULATOR STRUCTURE
CAM007 PROFILE**

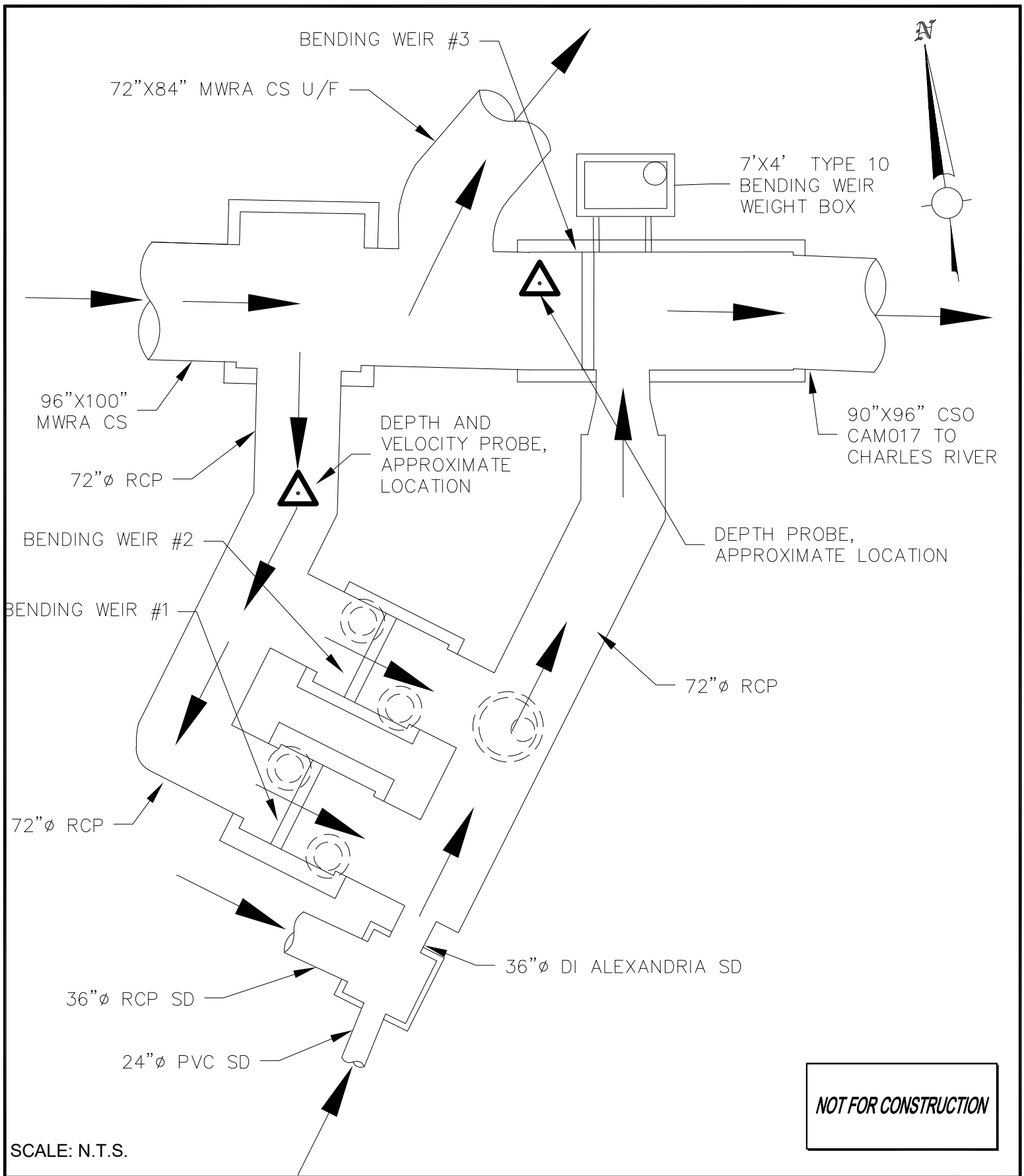

**CSO REGULATOR STRUCTURE
CAM017 PLAN**